

Court File No.:

**ONTARIO
SUPERIOR COURT OF JUSTICE
(COMMERCIAL LIST)**

BETWEEN:

BANK OF MONTREAL

Applicant

- and -

**THANE INTERNATIONAL, INC., THANE DIRECT, INC., THANE DIRECT
COMPANY, THANE DIRECT MARKETING INC., WEST COAST DIRECT
MARKETING, INC., THANE DIRECT CANADA INC. AND TDG, INC.**

Respondents

**APPLICATION UNDER section 243 of the *Bankruptcy and Insolvency Act*,
R.S.C. 1985, c. B-3, as amended, and under section 101 of the
Courts of Justice Act, R.S.O. 1990, c. C.43**

**APPLICATION RECORD
(Returnable October 23, 2015)**

GOWLING LAFLEUR HENDERSON LLP
Barristers and Solicitors
1 First Canadian Place
100 King Street West, Suite 1600
Toronto, Ontario M5X 1G5

Clifton P. Prophet (LSUC No.: 34845K)
Telephone: (416) 862-3509
Facsimile: (416) 862-7661

Solicitors for Bank of Montreal

TO: THE SERVICE LIST

SERVICE LIST

TO: **STIKEMAN ELLIOTT LLP**
5300 Commerce Court West
199 Bay Street
Toronto, Ontario M5L 1B9

Ashley Taylor
Tel: 416-869-5236
Fax: 416-947-0866
Email: ataylor@stikeman.com

Craig Mitchell
Tel: 416-869-5509
Email: cmitchell@stikeman.com

Solicitors for the Respondents

AND TO: **AIRD & BERLIS LLP**
Brookfield Place
181 Bay Street
Suite 1800, Box 754
Toronto, Ontario M5J 2T9

Steven L. Graff
Tel: 416-865-7726
Fax: 416-863-1515
Email: sgraff@airdberlis.com

Stanley W.L. Freedman
Tel: 416-865-7762
Email: sfreedman@airdberlis.com

Solicitors for 9472541 Canada Inc., 9472550 Canada Inc., 635427 Inc.,
and 652134 Limited

AND TO: BORDEN LADNER GERVAIS LLP

Scotia Place
40 King Street West, 44th Floor
Toronto, Ontario M5H 3Y4

Roger Jaipargas

Tel: 416-367-6266
Fax: 416-367-6000
Email: RJaipargas@blg.com

Gordon G. Raman

Tel: 416-367-6232
Email: GRaman@blg.com

Solicitors for Richter Advisory Group Inc.

AND TO: CHAPMAN AND CUTLER LLP

111 West Monroe Street
Chicago, Illinois 60603

Daniel W. Baker

Tel: 312-845-3790
Fax: 312-701-2361
Email: dbaker@chapman.com

David T.B. Audley

Tel: 312-845-2971
Email: audley@chapman.com

US Counsel to Bank of Montreal

AND TO: GOULSTON & STORRS

400 Atlantic Avenue
Boston, Massachusetts 02110-3333

James F. Wallack

Tel: 617-574-4107
Fax: 617-574-7646
Email: jwallack@goulstonstorrs.com

Gregory O. Kaden

Tel: 617-574-3818
Email: gkaden@goulstonstorrs.com

US Counsel to Richter Advisory Group Inc.

AND TO: DEPARTMENT OF JUSTICE (CANADA)

Ontario Regional Office
The Exchange Tower, Box 36
130 King Street West, Suite 3400
Toronto, Ontario M5X 1K6

Diane Winters

Tel: 416-973-3172
Fax: 416-973-0810
Email: diane.winters@justice.gc.ca

**AND TO: HER MAJESTY THE QUEEN IN RIGHT OF THE PROVINCE OF
ONTARIO AS REPRESENTED BY THE MINISTER OF FINANCE**

Revenue Collections Branch
Insolvency Unit
P.O. Box 620
33 King Street West, 6th Floor
Oshawa, Ontario L1H 8H5

AND TO: MINISTRY OF FINANCE

Legal Services Branch
College Park, 11th Floor
777 Bay Street
Toronto, Ontario M5G 2C8

Kevin O'Hara, Counsel

Tel: 416-327-8463
Email: kevin.ohara@ontario.ca

INDEX TAB

INDEX

<u>Document</u>	<u>Tab</u>
Notice of Application	1
Draft Appointment Order	A
Draft Approval, Vesting and Distribution Order	B
Affidavit of Paul Findlay sworn October 16, 2015	2
Consent of Richter Advisory Group Inc.	3

TAB 1

Court File No.

**ONTARIO
SUPERIOR COURT OF JUSTICE
(COMMERCIAL LIST)**

BETWEEN:

BANK OF MONTREAL

Applicant

- and -

**THANE INTERNATIONAL, INC., THANE DIRECT, INC., THANE DIRECT COMPANY,
THANE DIRECT MARKETING INC. WEST COAST DIRECT MARKETING, INC.,
THANE DIRECT CANADA INC. AND TDG, INC.**

Respondents

**Application under Section 243 of the *Bankruptcy and Insolvency Act*, R.S.C. 1985, c. B-3,
as amended, and under Section 101 of the *Courts of Justice Act*, R.S.O. 1990, c. C-43**

NOTICE OF APPLICATION

TO THE RESPONDENT(S)

A LEGAL PROCEEDING HAS BEEN COMMENCED by the applicant. The claim made by the applicant appears on the following page.

THIS APPLICATION will come on for a hearing on October 23, 2015, at 10:00 a.m., or as soon after that time as the Application can be heard before a judge presiding, at 330 University Avenue, Toronto, Ontario, M5G 1E6.

IF YOU WISH TO OPPOSE THIS APPLICATION, to receive notice of any step in the application or to be served with any documents in the application you or an Ontario lawyer acting for you must forthwith prepare a notice of appearance in Form 38A prescribed by the *Rules of Civil Procedure*, serve it on the applicant's lawyer or, where the applicant does not have a lawyer, serve it on the applicant, and file it, with proof of service, in this court office, and you or your lawyer must appear at the hearing.

IF YOU WISH TO PRESENT AFFIDAVIT OR OTHER DOCUMENTARY EVIDENCE TO THE COURT OR TO EXAMINE OR CROSS-EXAMINE WITNESSES

ON THE APPLICATION, you or your lawyer must, in addition to serving your notice of appearance, serve a copy of the evidence on the applicant's lawyer or, where the applicant does not have a lawyer, serve it on the applicant, and file it, with proof of service, in the court office where the application is to be heard as soon as possible, but at least four days before the hearing.

IF YOU FAIL TO APPEAR AT THE HEARING, JUDGMENT MAY BE GIVEN IN YOUR ABSENCE AND WITHOUT FURTHER NOTICE TO YOU. IF YOU WISH TO OPPOSE THIS APPLICATION BUT ARE UNABLE TO PAY LEGAL FEES, LEGAL AID MAY BE AVAILABLE TO YOU BY CONTACTING A LOCAL LEGAL AID OFFICE.

Date: _____ Issued by _____
Local Registrar

Address of
court office: 330 University Avenue, 10th Floor
Toronto ON M5G 1E6

TO: **SERVICE LIST**

APPLICATION

1. The Applicant makes application for orders, substantially in the forms attached as Schedules "A" and "B" hereto:
 - (a) appointing Richter Advisory Group Inc. ("**Richter**") as receiver (the "**Receiver**") without security, to exercise specific powers and duties with respect to the assets, undertakings and properties of the Respondents;
 - (b) appointing the Receiver as representative of the Debtors (defined below) for the purposes of seeking recognition of orders made in this Application from a court of competent jurisdiction exercising jurisdiction under the U.S. Bankruptcy Code in the District of Delaware;
 - (c) approving the sale transaction (the "**Transaction**") contemplated by an offer to purchase (the "**Sale Agreement**") made to the Receiver by 9472541 Canada Inc. ("**New Thane Holdco**"), 9472550 Canada Inc., 635427, Inc. and 652134 Limited as purchasers. (together, the "**New Thane Purchasers**") dated October 16, 2015;
 - (d) authorizing and directing the Receiver to enter into the Sale Agreement and vesting in the New Thane Purchasers the right, title and interest in and to the assets of the Respondents to be sold pursuant, and as described in the Sale Agreement (the "**Assets**");

- (e) authorizing and directing the distribution to the Lenders (defined below) of the cash purchase price for the Assets as part of the closing of the Transaction;
- (f) sealing certain confidential information in a report to be filed by Richter and in the Affidavit of Paul Findlay sworn October 16, 2015 (the "**Findlay Affidavit**"); and
- (g) for such further and other relief as counsel may advise and this Honourable Court permit.

2. The grounds for the application are:

The Parties

- (a) The applicant, Bank of Montreal ("**BMO**") is agent for a syndicate of lenders composed of: BMO, National Bank of Canada and HSBC Bank Canada (collectively, the "**Lenders**").
- (b) Thane Direct Company ("**Thane Canada**") and Thane Direct, Inc. ("**TDI**" or "**Thane U.S.**"), Thane Direct Marketing, Inc. ("**TDMI**"), Thane International, Inc., West Coast Direct Marketing Inc. ("**West Coast**"), TDG, Inc., and Thane Direct Canada Inc. ("**TDCI**"), along with other affiliated entities (the "**Thane Group**") operate a business (the "**Thane Business**") developing, marketing and selling products with a relatively short economic lifespan – examples include the X-5 Steam Mop and Abtronic exercise product.

- (c) The New Thane Purchasers are companies incorporated in Ontario, Delaware and the United Kingdom to acquire the Assets.

Appointment of Receiver

Credit Agreement and Security

- (d) On September 28, 2012, the Lenders, and BMO in its capacity as their agent, entered into a credit agreement (as amended, the "**Credit Agreement**") with Thane Canada and Thane U.S. (together the "**Borrowers**"). The current total amount of the indebtedness under the Credit Agreement is in excess of \$96.7 million plus interests and costs (the "**Indebtedness**").
- (e) Direct Marketing Holdings, Inc., Thane International, Inc., West Coast, TDG, Inc., TDCI and Thane Dutch Holdings Cooperatief E.A., are guarantors of the Indebtedness under the Credit Agreement (the "**Guarantors**" and together with the Borrowers, the "**Debtors**").
- (f) The Indebtedness is secured by a security agreements or general security agreements (the "**Security**") from West Coast, TDG, Inc., TDI, Thane International, Inc., Thane Canada, TDMI, TDCI and Direct Marketing Holdings.
- (g) The Lenders' Security is properly perfected, valid and enforceable.

Financial Difficulties and Default

- (h) In the Fall of 2013, the Borrowers notified the Lenders that they would be in breach of certain covenants under the Credit Agreement.
- (i) On or about October 31, 2013 the Borrowers failed to make a required installment payment under the Credit Agreement. This failure constitutes a default under the Credit Agreement.
- (j) Since November 12, 2013, the Agent, the Lenders and the Thane Group have entered into various forbearance arrangements and the Thane Group credit facilities have been subject to such forbearance arrangements.
- (k) The Thane Group is currently insolvent and Richter has consented to act as Receiver in these proceedings.

The SISP

- (l) It was a term of the forbearance arrangements put in place that the Thane Group undertake a sale and investor process ("**SISP**").
- (m) SSG Capital Advisors ("**SSG**"), an independent professional investment advisor, canvassed the market for sale and/or refinancing options as part of the SISP.
- (n) Despite the efforts of the parties in relation to the SISP, no acceptable arrangements could be made for the recapitalization or sale of the Thane Group to third parties.

- (o) In response to a letter of intent provided by Amir Tukulj and Russel Orelowitz on behalf of themselves and other members of the senior management of the Thane Group (the "**Management Shareholders**") the Agent and Lenders entered into discussions with the Management Shareholders for the sale and purchase of the Thane Business.
- (p) Ultimately, the Agent and Lenders and the Management Shareholders reached an agreement in principle for the sale and purchase of the Thane Business.

Transaction Approval

- (q) The New Thane Purchasers have offered to purchase the Thane Business for a purchase price of approximately US\$50 million, together with the assumption of most but not all of the existing contractual and trade creditor liabilities of the Thane Group and the payment of certain transaction costs.
- (r) The ultimate parent of the New Thane Purchasers is New Thane Holdco, whose shares will be owned, on terms agreed on in a shareholders agreement, in the following manner:
 - (i) by BMO and National Bank of Canada , through an intermediary holding company, as to a minority interest; and
 - (ii) The Management Shareholders as to a majority interest.

- (s) The Purchase of the Thane Business will be effected through the purchase of both shares and assets held by the Respondents.
- (t) The Transaction and the Sale Agreement with the New Thane Purchasers are conditional upon obtaining this Court's approval of the Transaction and ancillary relief from the U.S. Bankruptcy Court exercising its powers of recognition under Chapter 15 of the U.S. Bankruptcy Code with regard to property owned by those Respondents incorporated in and resident in the U.S.
- (u) The Receiver is an appropriate foreign representative of the Respondents for the purposes of taking Chapter 15 proceedings under the U.S. Bankruptcy Code.
- (v) The Transaction will permit the Thane Business to continue and its suppliers and employees to have the benefit of continuing contracts and jobs and the purchase price represents fair value for the relevant assets and shares.
- (w) Neither a liquidation or any alternative going concern sale of the Thane Business would come close to providing value sufficient to retire the Lender's properly perfected senior secured loans and a liquidation would be likely to significantly increase the Lender's losses on their existing senior secured debt.

Distribution

- (x) Under the Sale Agreement, the purchase price for the Transaction is to be funded by way of financing to be provided to New Thane Holdco by the Lenders, and the cash proceeds of the transaction are to be immediately distributed by the Receiver and applied in reduction of the existing indebtedness owed by Thane Canada and Thane U.S. to the Lenders.
- (y) The Indebtedness significantly exceeds the recovery under the Transaction and the Agent and the Lenders hold valid and enforceable security interests over the assets and shares being sold.

Sealing

- (z) A report to be filed by Richter in relation to the Application and a paragraph in the Findlay Affidavit reference expert opinion evidence concerning the value of the Thane Business.
- (aa) This valuation information is commercially sensitive; could be prejudicial if disclosed; and, should be sealed in the files of this Court to protect its confidentiality.

General

- (bb) Section 243 of the *Bankruptcy and Insolvency Act*, as amended.
- (cc) Section 101 of the *Courts of Justice Act*.
- (dd) The relief sought is just and convenient
- (ee) Such further and other grounds as the lawyers may advise.

3. The following documentary evidence will be used at the hearing of the application:

- (a) The affidavit of Paul Findley sworn October 16, 2015;
- (b) The Report of Richter, to be filed;
- (c) The Consent of Richter to act as Receiver; and
- (d) Such further and other evidence as the lawyers may advise and this Honourable Court may permit.

(Date of issue)

GOWLING LAFLEUR HENDERSON LLP

Barristers & Solicitors

1 First Canadian Place

100 King Street West, Suite 1600

Toronto ON M5X 1G5

Tel: 416-862-7525

Fax: 416-862-7661

Clifton P Prophet (#34845K)

Tel: 416-862-3509

Fax: 416-863-3509

clifton.prophet@gowlings.com

David Cohen (#33195Q)

Tel: 416-862-6667

Fax: 416-862-7661

david.cohen@gowlings.com

Solicitors for the Applicant

BANK OF MONTREAL

- and -
APPLICANT

THANE INTERNATIONAL INC. ET AL.
RESPONDENTS

**ONTARIO
SUPERIOR COURT OF JUSTICE
PROCEEDING COMMENCED AT
TORONTO**

NOTICE OF APPLICATION

GOWLING LAFLEUR HENDERSON LLP
Barristers & Solicitors
1 First Canadian Place
100 King Street West, Suite 1600
Toronto ON M5X 1G5

Tel: 416-862-7525
Fax: 416-862-7661

Clifton P Prophet (#34845K)

Tel: 416-862-3509
Fax: 416-863-3509
clifton.prophet@gowlings.com

David Cohen (#33195Q)

Tel: 416-862-
Fax: 416-862-7661
david.cohen@gowlings.com

Solicitors for the Applicant

TAB A

Court File No.:

**ONTARIO
SUPERIOR COURT OF JUSTICE
(COMMERCIAL LIST)**

THE HONOURABLE)	FRIDAY, THE 23rd DAY
)	
JUSTICE)	OF OCTOBER , 2015

BETWEEN:

BANK OF MONTREAL

Applicant

- and -

**THANE INTERNATIONAL, INC., THANE DIRECT, INC., THANE DIRECT
COMPANY, THANE DIRECT MARKETING INC., WEST COAST DIRECT
MARKETING, INC., THANE DIRECT CANADA INC. AND TDG, INC.**

Respondents

**APPLICATION UNDER section 243 of the *Bankruptcy and Insolvency Act*,
R.S.C. 1985, c. B-3, as amended, and under section 101 of the
Courts of Justice Act, R.S.O. 1990, c. C.43**

APPOINTMENT ORDER

THIS APPLICATION made by Bank of Montreal ("BMO" or the "Applicant") for an Order pursuant to section 243(1) of the *Bankruptcy and Insolvency Act*, R.S.C. 1985, c. B-3, as amended (the "BIA") and section 101 of the *Courts of Justice Act*, R.S.O. 1990, c. C.43, as amended (the "CJA") appointing Richter Advisory Group Inc. as receiver (the "Receiver"), without security, to exercise the powers and duties specifically set out in this Order with respect to the assets, undertakings and properties of the Respondents (collectively, the "Debtors") held

for, or used in relation to, a business carried on by the Debtors, was heard this day at 330 University Avenue, Toronto, Ontario.

ON READING the Affidavit of Paul Findlay sworn October 16, 2015, and the Exhibits thereto, and the Report of Richter Advisory Group Inc. (“Richter”) dated October ●, 2015 in its capacity as proposed Receiver (the “Pre-Appointment Report”) and on hearing the submissions of counsel for the Applicant, counsel for the Receiver and counsel for New Thane Holdco, no one appearing for any other party although duly served as appears from the Affidavits of Service of Alma Cano and on reading the Consent of Richter Advisory Group Inc. to act as the Receiver,

SERVICE

1. **THIS COURT ORDERS** that the time for service of the Notice of Application, the Application Record herein and the Pre-Appointment Report is hereby abridged, if necessary, and that this application is properly returnable today and that service, including the form, manner and time that such service was actually effected on all parties, is hereby validated, and where such service was not effected such service is hereby dispensed with.

APPOINTMENT

2. **THIS COURT ORDERS** that pursuant to section 243(1) of the BIA and section 101 of the CJA Richter is hereby appointed Receiver, without security, to exercise the powers and duties specifically set out in this Order with respect to the assets, undertakings and properties of the Debtors held for, and used in relation to, a business carried on by the Debtors (the “Property”) and all proceeds thereof.

3. **THIS COURT ORDERS** that subject to further Order of this Court, the Debtors shall remain in possession and control of the Property and the Receiver shall not be or be deemed to be in possession and control of the Property.

4. **THIS COURT ORDERS** that subject to further Order of this Court, the Debtors shall carry on their business in the normal course and shall pay the expenses arising from their business as they fall due and except to the extent that the Receiver exercises the powers granted

pursuant to paragraph 5 hereof the Receiver shall not interfere with the carrying on of the business of the Debtors.

RECEIVER'S POWERS

5. **THIS COURT ORDERS** that the Receiver is hereby empowered and authorized, but not obligated to do any of the following where the Receiver considers it necessary or desirable:

- (a) to take possession of and exercise control over any and all proceeds or receipts arising out of or from the Property;
- (b) to engage consultants, appraisers, agents, experts, auditors, accountants, managers, counsel and such other persons from time to time and on whatever basis, including on a temporary basis, to assist with the exercise of the Receiver's powers and duties, including without limitation those conferred by this Order;
- (c) to execute, assign, issue and endorse documents of whatever nature in respect of any of the Property, whether in the Receiver's name or in the name and on behalf of the Debtors, for any purpose pursuant to this Order;
- (d) to sell, convey, transfer or assign the Property or any part or parts thereof out of the ordinary course of business with the approval of this Court and in such case notice under subsection 63(4) of the Ontario *Personal Property Security Act*, or section 31 of the Ontario *Mortgages Act*, as the case may be, shall not be required, and in each case the Ontario *Bulk Sales Act* shall not apply;
- (e) to apply for any vesting order or other orders necessary to convey the Property or any part or parts thereof to a purchaser or purchasers thereof, free and clear of any liens or encumbrances affecting such Property;
- (f) to report to, meet with and discuss with such affected Persons (as defined below) as the Receiver deems appropriate on all matters relating to the Property and the receivership, and to share information, subject to such terms as to confidentiality as the Receiver deems advisable;

- (g) to register a copy of this Order and any other Orders in respect of the Property against title to any of the Property;
- (h) to take any steps reasonably incidental to the exercise of these powers or the performance of any statutory obligations.

and in each case where the Receiver takes any such actions or steps, it shall be exclusively authorized and empowered to do so, to the exclusion of all other Persons (as defined below), including the Debtors, and without interference from any other Person.

NO PROCEEDINGS AGAINST THE RECEIVER

6. **THIS COURT ORDERS** that no proceeding or enforcement process in any court or tribunal (each, a "Proceeding"), shall be commenced or continued against the Receiver except with the written consent of the Receiver or with leave of this Court.

NO PROCEEDINGS AGAINST THE DEBTORS OR THE PROPERTY

7. **THIS COURT ORDERS** that no Proceeding against or in respect of the Debtors or any one of them or the Property shall be commenced or continued except with the written consent of the Receiver or with leave of this Court and any and all Proceedings currently under way against or in respect of the Debtors or any one of them or the Property are hereby stayed and suspended pending further Order of this Court.

NO EXERCISE OF RIGHTS OR REMEDIES

8. **THIS COURT ORDERS** that all rights and remedies against the Debtors, the Receiver, or affecting the Property, are hereby stayed and suspended except with the written consent of the Receiver or leave of this Court, provided, however, that this stay and suspension does not apply in respect of any "eligible financial contract" as defined in the BIA, and further provided that nothing in this paragraph shall (i) empower the Debtors to carry on any business which the Debtors are not lawfully entitled to carry on, (ii) exempt the Debtors from compliance with statutory or regulatory provisions relating to health, safety or the environment, (iii) prevent the filing of any registration to preserve or perfect a security interest, or (iv) prevent the registration of a claim for lien.

NO INTERFERENCE WITH CONTRACTS

9. **THIS COURT ORDERS** that no Person shall discontinue, fail to honour, alter, interfere with, repudiate, terminate or cease to perform any right, renewal right, contract, agreement, licence or permit in favour of or held by the Debtors or any one of them, without written consent of the Receiver or leave of this Court.

CONTINUATION OF SERVICES

10. **THIS COURT ORDERS** that all Persons having oral or written agreements with the Debtors or any one of them, or statutory or regulatory mandates for the supply of goods and/or services, including without limitation, all computer software, communication and other data services, centralized banking services, payroll services, insurance, transportation services, utility or other services to the Debtors or any one of them, are hereby restrained until further Order of this Court from discontinuing, altering, interfering with or terminating the supply of such goods or services as may be required by the Debtors or any one of them, and that the Debtors shall be entitled to the continued use of their current telephone numbers, facsimile numbers, internet addresses and domain names, provided in each case that the normal prices or charges for all such goods or services received after the date of this Order are paid by the Debtors in accordance with normal payment practices of the Debtors or such other practices as may be agreed upon by the supplier or service provider and the Debtors, or as may be ordered by this Court.

EMPLOYEES

11. **THIS COURT ORDERS** that all employees of the Debtors shall remain the employees of the Debtors until such time as the Debtors may terminate the employment of such employees. The Receiver shall not be liable for any employee-related liabilities, including any successor employer liabilities as provided for in section 14.06(1.2) of the BIA.

LIMITATION ON ENVIRONMENTAL LIABILITIES

12. **THIS COURT ORDERS** that nothing herein contained shall require the Receiver to occupy or to take control, care, charge, possession or management (separately and/or collectively, "Possession") of any of the Property that might be environmentally contaminated,

might be a pollutant or a contaminant, or might cause or contribute to a spill, discharge, release or deposit of a substance contrary to any federal, provincial or other law respecting the protection, conservation, enhancement, remediation or rehabilitation of the environment or relating to the disposal of waste or other contamination including, without limitation, the *Canadian Environmental Protection Act*, the *Ontario Environmental Protection Act*, the *Ontario Water Resources Act*, or the *Ontario Occupational Health and Safety Act* and regulations thereunder (the “Environmental Legislation”), provided however that nothing herein shall exempt the Receiver from any duty to report or make disclosure imposed by applicable Environmental Legislation. The Receiver shall not, as a result of this Order or anything done in pursuance of the Receiver’s duties and powers under this Order, be deemed to be in Possession of any of the Property within the meaning of any Environmental Legislation, unless it is actually in possession.

LIMITATION ON THE RECEIVER’S LIABILITY

13. THIS COURT ORDERS that the Receiver shall incur no liability or obligation as a result of its appointment, the carrying out of the provisions of this Order, or arising from the business carried on by the Debtors, including liabilities or obligations in respect of taxes, withholdings, interest, penalties or other like claims, save and except for any gross negligence or wilful misconduct on its part. Nothing in this Order shall derogate from the protections afforded the Receiver by section 14.06 of the BIA or by any other applicable legislation.

RECEIVER’S ACCOUNTS

14. THIS COURT ORDERS that the Receiver and counsel to the Receiver shall be paid their reasonable fees and disbursements, in each case at their standard rates and charges unless otherwise ordered by the Court on the passing of accounts, and that the Receiver and counsel to the Receiver shall be entitled to and are hereby granted a charge (the “Receiver’s Charge”) on the Property, as security for such fees and disbursements, both before and after the making of this Order in respect of these proceedings, and that the Receiver’s Charge shall form a first charge on the Property in priority to all security interests, trusts, liens, charges and encumbrances, statutory or otherwise, in favour of any Person, but subject to sections 14.06(7), 81.4(4), and 81.6(2) of the BIA.

15. THIS COURT ORDERS that the Receiver and its legal counsel shall pass its accounts from time to time, and for this purpose the accounts of the Receiver and its legal counsel are hereby referred to a judge of the Commercial List of the Ontario Superior Court of Justice.

SERVICE AND NOTICE

16. THIS COURT ORDERS that the E-Service Protocol of the Commercial List (the "Protocol") is approved and adopted by reference herein and, in this proceeding, the service of documents made in accordance with the Protocol (which can be found on the Commercial List website at <http://www.ontariocourts.ca/scj/practice/practice-directions/toronto/e-service-protocol/>) shall be valid and effective service. Subject to Rule 17.05 this Order shall constitute an order for substituted service pursuant to Rule 16.04 of the Rules of Civil Procedure. Subject to Rule 3.01(d) of the Rules of Civil Procedure and paragraph 21 of the Protocol, service of documents in accordance with the Protocol will be effective on transmission. This Court further orders that a Case Website shall be established in accordance with the Protocol with the following URL <http://www.richter.ca/en/folder/insolvency-cases/t/thane-direct-company-et-al>.

17. THIS COURT ORDERS that if the service or distribution of documents in accordance with the Protocol is not practicable, the Receiver is at liberty to serve or distribute this Order, any other materials and orders in these proceedings, any notices or other correspondence, by forwarding true copies thereof by prepaid ordinary mail, courier, personal delivery or facsimile transmission to the Debtor's creditors or other interested parties at their respective addresses as last shown on the records of the Debtors and that any such service or distribution by courier, personal delivery or facsimile transmission shall be deemed to be received on the next business day following the date of forwarding thereof, or if sent by ordinary mail, on the third business day after mailing.

BANKRUPTCY OF THE DEBTORS

18. THIS COURT ORDERS that nothing in this Order shall prevent the Receiver from acting as a trustee in bankruptcy of the Debtors.

19. THIS COURT ORDERS that the Receiver is hereby authorized and empowered but not obligated to make assignments in bankruptcy and act as trustee in bankruptcy (in such capacity the "Trustee") in respect of those Debtors that reside, carry on business or have property in Canada. In respect of any of the Debtors that do not reside, carry on business or have property in Canada, the Receiver is authorized and empowered but not obligated to take like steps under the laws of the United States, to the extent permitted by applicable law.

GENERAL

20. THIS COURT ORDERS that the Receiver may from time to time apply to this Court for advice and directions in the discharge of its powers and duties hereunder.

21. THIS COURT ORDERS that the Receiver is hereby appointed as the authorized foreign representative of the Debtors for the purposes of taking proceedings pursuant to Chapter 15 of the United States Bankruptcy Code in respect of the Debtors and is authorized to take such proceedings.

22. THIS COURT HEREBY REQUESTS the aid and recognition of any court, tribunal, regulatory or administrative body having jurisdiction in Canada or in the United States to give effect to this Order and to assist the Receiver and its agents in carrying out the terms of this Order. All courts, tribunals, regulatory and administrative bodies are hereby respectfully requested to make such orders and to provide such assistance to the Receiver, as an officer of this Court, as may be necessary or desirable to give effect to this Order or to assist the Receiver and its agents in carrying out the terms of this Order.

23. THIS COURT ORDERS that the Receiver be at liberty and is hereby authorized and empowered to apply to any court, tribunal, regulatory or administrative body, wherever located, for the recognition of this Order and for assistance in carrying out the terms of this Order, and that the Receiver is authorized and empowered to act as a representative in respect of the within proceedings for the purpose of having these proceedings recognized in a jurisdiction outside Canada.

24. THIS COURT ORDERS that any interested party may apply to this Court to vary or amend this Order on not less than seven (7) days' notice to the Receiver and to any other party likely to be affected by the order sought or upon such other notice, if any, as this Court may order.

Court File No.:

BANK OF MONTREAL - and - **THANE INTERNATIONAL, INC., THANE DIRECT, INC., THANE DIRECT COMPANY, THANE DIRECT MARKETING INC., WEST COAST DIRECT MARKETING, INC., THANE DIRECT CANADA INC. AND TDG, INC.**

Applicant

Respondents

ONTARIO
SUPERIOR COURT OF JUSTICE
(COMMERCIAL LIST)

(PROCEEDING COMMENCED AT TORONTO)

APPOINTMENT ORDER

Gowling Lafleur Henderson LLP
Barristers and Solicitors
1 First Canadian Place
100 King Street West, Suite 1600
Toronto, Ontario M5X 1G5

Clifton P. Prophet (LSUC No.: 34845K)
Telephone: (416) 862-3509
Facsimile: (416) 862-7661

Solicitors for Bank of Montreal

TAB B

Court File No.:

**ONTARIO
SUPERIOR COURT OF JUSTICE
(COMMERCIAL LIST)**

THE HONOURABLE)	FRIDAY, THE 23rd DAY
)	
JUSTICE)	OF OCTOBER , 2015

BETWEEN:

BANK OF MONTREAL

Applicant

- and -

**THANE INTERNATIONAL, INC., THANE DIRECT, INC., THANE DIRECT
COMPANY, THANE DIRECT MARKETING INC., WEST COAST DIRECT
MARKETING, INC., THANE DIRECT CANADA INC. AND TDG, INC.**

Respondents

**APPLICATION UNDER section 243 of the *Bankruptcy and Insolvency Act*,
R.S.C. 1985, c. B-3, as amended, and under section 101 of the
Courts of Justice Act, R.S.O. 1990, c. C.43**

APPROVAL, VESTING AND DISTRIBUTION ORDER

THIS APPLICATION made by Bank of Montreal, in its capacity as agent (“**BMO**” or the “**Applicant**”) for certain lenders, including Bank of Montreal, forming a syndicate (the “**Lenders**”) pursuant to a Credit Agreement dated September 28, 2012 between BMO and the Lenders and the Respondents and certain other related entities, as amended from time to time (the “**Credit Agreement**”), for an Order:

- 2 -

- (a) approving the sale transaction (the “**Transaction**”) contemplated by an offer to purchase (the “**Sale Agreement**”) made to Richter Advisory Group Inc. in its capacity as receiver of the Respondents (the “**Receiver**” or the “**Seller**”) by 9472541 Canada Inc., 9472550 Canada Inc., 635427, Inc. and 652134 Limited as purchasers. (together, the “**New Thane Purchasers**”) dated October 16, 2015 and appended to the Affidavit of Paul Findlay sworn October 16, 2015 (the “**Findlay Affidavit**”);
- (b) authorizing and directing the Receiver to enter into the Sale Agreement and vesting in the New Thane Purchasers the right, title and interest in and to the assets of the Debtors (defined below) to be sold pursuant to and as described in the Sale Agreement (the “**Assets**”);
- (c) providing for distribution to the Lenders of the cash purchase price for the Assets; and,
- (d) for related relief,

was heard this day at 330 University Avenue, Toronto, Ontario.

ON READING the Findlay Affidavit and the Exhibits thereto, and the Report of Richter Advisory Group Inc. (“**Richter**”) dated October ●, 2015 in its capacity as proposed Receiver (the “**Pre-Appointment Report**”) and on hearing the submissions of counsel for BMO, counsel for the Receiver, counsel for the Respondents Thane International, Inc., Thane Direct, Inc., Thane Direct Company, Thane Direct Marketing Inc., West Coast Direct Marketing, Inc., Thane Direct Canada Inc. and TDG, Inc. (together, the “**Debtors**”) and counsel for the New Thane Purchasers, no one appearing for any other party although duly served as appears from the Affidavits of Service of Alma Cano,

SERVICE

1. **THIS COURT ORDERS** that the time for service of the Notice of Application, the Application Record herein and the Pre-Appointment Report is hereby abridged, if necessary, and that this application is properly returnable today and that service, including the form, manner and

time that such service was actually effected on all parties, is hereby validated, and where such service was not effected such service is hereby dispensed with.

APPROVAL

2. **THIS COURT ORDERS AND DECLARES** that the Transaction and the Sale Agreement are hereby approved, and that the Sale Agreement is commercially reasonable and in the best interests of the Debtors and their stakeholders. The Receiver is hereby authorized and directed to execute the Sale Agreement, with such minor amendments as the Receiver may deem necessary. The Receiver is hereby further authorized and directed to take such additional steps and execute such additional documents as may be necessary or desirable for the completion of the Transaction and for the conveyance of the Assets to the New Thane Purchasers, including, without limitation, taking proceedings pursuant to Chapter 15 of the United States Bankruptcy Code in respect of the Transaction and the Sale Agreement.

3. **THIS COURT ORDERS** that the Pre-Appointment Report and the activities and conduct of Richter described therein be and the same are hereby approved.

VESTING AND DISTRIBUTION

4. **THIS COURT ORDERS AND DECLARES** that upon the delivery of a Receiver's certificate to the New Thane Purchasers substantially in the form attached as **Schedule "A"** hereto (the "**Receiver's Certificate**"), all of the Debtors' right, title and interest in and to the Assets described in the Sale Agreement and described in summary form in **Schedule "B"** hereto shall vest absolutely in each of the New Thane Purchasers as set out in **Schedule "B"**, free and clear of and from any and all security interests (whether contractual, statutory, or otherwise), hypothecs, mortgages, trusts or deemed trusts (whether contractual, statutory, or otherwise), liens, executions, levies, charges, or other financial or monetary claims, whether or not they have attached or been perfected, registered or filed and whether secured, unsecured or otherwise (collectively, the "**Claims**") including, without limiting the generality of the foregoing: (i) any encumbrances or charges created by the Order of the Honourable Justice ● dated ●, 20●; (ii) all charges, security interests or claims evidenced by registrations pursuant to the *Personal Property Security Act* (Ontario) or any other personal property registry system; and (iii) those

Claims listed on **Schedule "C"** hereto (all of which are collectively referred to as the "**Encumbrances**" which term shall not include the permitted encumbrances listed on **Schedule "D"** hereto) and, for greater certainty, this Court orders that all of the Encumbrances affecting or relating to the Assets are hereby expunged and discharged as against the Assets.

5. **THIS COURT ORDERS AND DIRECTS** the Receiver to file with the Court a copy of the Receiver's Certificate, forthwith after delivery thereof.

6. **THIS COURT ORDERS** that all cash proceeds of sale of the Assets as provided for under the Sale Agreement shall, as part of the closing of the Transactions, be immediately paid or caused to be paid by the Receiver to the Agent for the benefit of the Lenders (the "**Distribution**") to be applied on account of and in partial payment of the obligations due and owing by the Debtors or any of them to the Lenders pursuant to the Credit Agreement and the Distribution may be effected by way of direction.

7. **THIS COURT ORDERS** that, pursuant to clause 7(3)(c) of the *Canada Personal Information Protection and Electronic Documents Act*, the Receiver and the Debtors are authorized and permitted to disclose and transfer to the New Thane Purchasers all human resources and payroll information in the Company's records pertaining to the Debtor's past and current employees, including personal information of those employees to be hired by the New Thane Purchasers pursuant to the Sale Agreement. The New Thane Purchasers shall maintain and protect the privacy of such information and shall be entitled to use the personal information provided to it in a manner which is in all material respects identical to the prior use of such information by the Debtor.

8. **THIS COURT ORDERS** that, notwithstanding:

- (a) the pendency of these proceedings;
- (b) any applications for a bankruptcy order now or hereafter issued pursuant to the *Bankruptcy and Insolvency Act* (Canada) in respect of the Debtors and any bankruptcy order issued pursuant to any such applications; and
- (c) any assignment in bankruptcy made in respect of the Debtors;

the vesting of the Assets in the New Thane Purchasers pursuant to this Order shall be binding on any trustee in bankruptcy that may be appointed in respect of the Debtors and shall not be void or voidable by creditors of the Debtors, nor shall it constitute nor be deemed to be a fraudulent preference, assignment, fraudulent conveyance, transfer at undervalue, or other reviewable transaction under the *Bankruptcy and Insolvency Act* (Canada) or any other applicable federal or provincial legislation, nor shall it constitute oppressive or unfairly prejudicial conduct pursuant to any applicable federal or provincial legislation.

9. **THIS COURT ORDERS AND DECLARES** that the Transaction is exempt from the application of the *Bulk Sales Act* (Ontario).

SEALING

10. **THIS COURT ORDERS AND DECLARES** that Appendix “●” to the ●, being the Report on Valuation of the Debtors dated October 16, 2015 prepared by Ernst & Young LLP (the “**Valuation Report**”), and paragraphs ● of the ● and paragraph ● of the Findlay Affidavit, being summaries of or references to the Valuation Report, shall be treated as confidential and shall be sealed and segregated from the public record, pending the closing of the Transaction contemplated by the Sale Agreement.

GENERAL

11. **THIS COURT ORDERS** that the Receiver may from time to time apply to this Court for advice and directions in the discharge of its powers and duties hereunder.

12. **THIS COURT HEREBY REQUESTS** the aid and recognition of any court, tribunal, regulatory or administrative body having jurisdiction in Canada or in the United States to give effect to this Order and to assist the Receiver and its agents in carrying out the terms of this Order. All courts, tribunals, regulatory and administrative bodies are hereby respectfully requested to make such orders and to provide such assistance to the Receiver, as an officer of this Court, as may be necessary or desirable to give effect to this Order or to assist the Receiver and its agents in carrying out the terms of this Order.

13. **THIS COURT ORDERS** that the Receiver be at liberty and is hereby authorized and empowered to apply to any court, tribunal, regulatory or administrative body, wherever located, for the recognition of this Order and for assistance in carrying out the terms of this Order, and that the Receiver is authorized and empowered to act as a representative in respect of the within proceedings for the purpose of having these proceedings recognized in a jurisdiction outside Canada.

SCHEDULE "A"

Form of Receiver's Certificate

Court File No.: CV-15- ●

**ONTARIO
SUPERIOR COURT OF JUSTICE
(COMMERCIAL LIST)**

BETWEEN:

BANK OF MONTREAL

Applicant

- and -

**THANE INTERNATIONAL, INC., THANE DIRECT, INC., THANE DIRECT
COMPANY, THANE DIRECT MARKETING INC., WEST COAST DIRECT
MARKETING, INC., THANE DIRECT CANADA INC. AND TDG, INC.**

Respondents

**APPLICATION UNDER section 243 of the *Bankruptcy and Insolvency Act*,
R.S.C. 1985, c. B-3, as amended, and under section 101 of the
Courts of Justice Act, R.S.O. 1990, c. C.43**

RECEIVER'S CERTIFICATE

RECITALS

A. Pursuant to an Order of the Honourable ● of the Ontario Superior Court of Justice (the "Court") dated ●, Richter Advisory Group Inc. was appointed as the receiver (the "Receiver") of the assets, undertakings and properties of the Respondents (the "Debtors").

B. Pursuant to an Order of the Court dated ●, the Court approved the sale transaction (the "Transaction") contemplated by an offer to purchase made to the Receiver by 9472541 Canada

Inc., 9472550 Canada Inc., 635427, Inc. and 652134 Limited (together, the “**New Thane Purchasers**”) made as of October 16, 2015 (the “**Sale Agreement**”) and provided for the vesting in the New Thane Purchasers of the Debtors’ right, title and interest in and to the assets of the Debtors to be sold pursuant to and as described in the Sale Agreement, (the “**Assets**”), which vesting is to be effective with respect to the Assets upon the delivery by the Receiver to the New Thane Purchasers of a certificate confirming (i) the payment by the New Thane Purchasers of the Purchase Price (as defined in the Sale Agreement) for the Assets; (ii) that the conditions to Closing as set out in Article 4 of the Sale Agreement have been satisfied or waived by the Receiver and the New Thane Purchasers; and (iii) the Transaction has been completed to the satisfaction of the Receiver.

C. Unless otherwise indicated herein, terms with initial capitals have the meanings set out in the Sale Agreement.

THE RECEIVER CERTIFIES the following:

1. The New Thane Purchasers have paid the Purchase Price for the Assets payable on the Closing Date pursuant to the Sale Agreement;
2. The conditions to Closing as set out in Article 4 of the Sale Agreement have been satisfied or waived by the Receiver and the New Thane Purchasers; and
3. The Transaction has been completed to the satisfaction of the Receiver.
4. This Certificate was delivered by the Receiver at ● on ●.

Richter Advisory Group Inc., in its capacity as Receiver of the assets, undertakings and properties of the Debtors, and not in its personal capacity

Per: _____
 Name:
 Title:

SCHEDULE "B"

Vesting of Assets

Thane Receivership Company	Assets/Shares Being Sold	Purchaser
Thane International, Inc.	IP Assets	652134 Limited ("New Thane IPCO (UK)")
	Other Assets	635427, Inc. ("New Thane US")
Thane Direct, Inc.	Shares – 80% equity interest in Grupo Mejor Compra SAPI de CV	9472541 Canada Inc. ("New Thane Holdco")
	Other Assets	New Thane Holdco
Thane Direct Company	Shares: <ul style="list-style-type: none"> • Danoz Direct Pty Ltd. • TVNS Scandanavia AB • Thane Direct UK Ltd. 	New Thane Holdco
	IP Assets	New Thane IPCO (UK)
	Other Assets	9472550 Canada Inc. ("New Thane Canada")
	IP Licence with New Thane IPCO(UK)	New Thane Canada
Thane Direct Marketing Inc.	Shares: <ul style="list-style-type: none"> • Medio Latino Inc. • Thane USA, Inc. 	New Thane U.S.
	Other Assets	New Thane Canada
West Coast Direct Marketing, Inc.	Other Assets	New Thane U.S.
TDG, Inc.	Other Assets	New Thane U.S.
Thane Direct Canada Inc.	IP Assets	New Thane IPCO (UK)
	IP Licence with New Thane IPCO (UK)	New Thane Canada
	Other Assets	New Thane Canada

Note that in the foregoing chart "Other Assets" refers to any asset owned by a Thane Receivership

Company except intellectual property assets, intellectual property licence rights pursuant to licences given to certain of the Thane Receivership Companies by New Thane IPCO (UK) as a closing step and Excluded Assets described in the Offer. Other Assets can include Thane Group contractual rights, equipment, inventory and accounts receivable, as applicable.

SCHEDULE "C"**Encumbrances**

A. Personal Property Security Act						
1.	Bank of Montreal, as Agent	666420336	20101207 1700 1590 3006 (6 years)	December 7, 2010	Thane Direct Company	I, E, A, O, MV
2.	Bank of Montreal, as Agent	666420327	20101207 1659 1590 3005 (6 years)	December 7, 2010	Thane Direct Canada Inc.	I, E, A, O, MV
3.	Bank of Montreal, as Agent	710681778	20151007 1623 1862 9770 (2 years)	October 7, 2015	Thane Direct Marketing Inc.	I, E, A, O, MV
4.	Bank of Montreal, as Agent	666420354	20101207 1700 1590 3007 (6 years)	December 7, 2010	Thane Direct, Inc.	I, E, A, O, MV
B. Uniform Commercial Code						

SCHEDULE "D"

Permitted Encumbrances

BMW Canada Inc.	703790991	20150224 1039 1529 9581 (4 years)	February 24, 2015	Thane Direct Canada Inc.	E, O, MV Amount: \$75149 2015 BMW Model X6 xDrive 35I
BMW Canada Inc.	701504037	20141112 1442 1530 2922 (5 years)	November 12, 2014	Thane Direct Canada Inc.	CG, E, O, MV Amount: \$69169 2015 BMW, Model X4 xDrive 35I
Mercedes-Benz Financial Services Canada Corporation and Mercedes-Benz Financial	692119602	20131125 1942 1531 4299 (3 years)	November 25, 2013	Thane Direct Canada Inc.	E, O, MV 2014 Mercedes-Benz, Model GLK3504M
Mercedes-Benz Financial Services Canada Corporation and Mercedes-Benz Financial	691288407	20131023 1937 1531 9932 (3 years)	October 23, 2013	Thane Direct Canada Inc.	CG, E, O, MV Amount: \$73612 2014 Mercedes-Benz, Model E350C4M

Mercedes-Benz Financial Services Canada Corporation and Mercedes-Benz Financial	687481461	20130604 1937 1531 9933 (3 years)	June 4, 2013	Thane Direct Canada Inc.	E, O, MV 2014 Mercedes-Benz Model E550W4M
---	-----------	--------------------------------------	--------------	--------------------------	---

Court File No.:

BANK OF MONTREAL - and - **THANE INTERNATIONAL, INC., THANE DIRECT, INC., THANE DIRECT COMPANY, THANE DIRECT MARKETING INC., WEST COAST DIRECT MARKETING, INC., THANE DIRECT CANADA INC. AND TDG, INC.**

Applicant

Respondents

**ONTARIO
SUPERIOR COURT OF JUSTICE
(COMMERCIAL LIST)**

(PROCEEDING COMMENCED AT TORONTO)

**APPROVAL, VESTING AND DISTRIBUTION
ORDER**

Gowling Lafleur Henderson LLP
Barristers and Solicitors
1 First Canadian Place
100 King Street West, Suite 1600
Toronto, Ontario M5X 1G5

Clifton P. Prophet (LSUC No.: 34845K)
Telephone: (416) 862-3509
Facsimile: (416) 862-7661

Solicitors for Bank of Montreal

Court File No.:

BANK OF MONTREAL - and - **THANE INTERNATIONAL, INC., THANE DIRECT, INC., THANE DIRECT COMPANY, THANE DIRECT MARKETING INC., WEST COAST DIRECT MARKETING, INC., THANE DIRECT CANADA INC. AND TDG, INC.**

Applicant

Respondents

**ONTARIO
SUPERIOR COURT OF JUSTICE
(COMMERCIAL LIST)**

(PROCEEDING COMMENCED AT TORONTO)

NOTICE OF APPLICATION

Gowling Lafleur Henderson LLP
Barristers and Solicitors
1 First Canadian Place
100 King Street West, Suite 1600
Toronto, Ontario M5X 1G5

Clifton P. Prophet (LSUC No.: 34845K)
Telephone: (416) 862-3509
Facsimile: (416) 862-7661

Solicitors for Bank of Montreal

TAB 2

Court File No.:

**ONTARIO
SUPERIOR COURT OF JUSTICE
(COMMERCIAL LIST)**

BETWEEN:

BANK OF MONTREAL

Applicant

- and -

**THANE INTERNATIONAL, INC., THANE DIRECT, INC., THANE DIRECT
COMPANY, THANE DIRECT MARKETING INC., WEST COAST DIRECT
MARKETING, INC., THANE DIRECT CANADA INC. AND TDG, INC.**

Respondents

**Application under Section 243 of the *Bankruptcy and Insolvency Act*, R.S.C. 1985, c. B-3,
as amended, and under Section 101 of the *Courts of Justice Act*, R.S.O. 1990, c. C-43**

**AFFIDAVIT OF PAUL FINDLAY
(Sworn October 16, 2015)**

**I, PAUL FINDLAY, of the City of Vaughan, in the Province of Ontario, MAKE
OATH AND SAY AS FOLLOWS:**

1. I am a Senior Manager, Special Loans, employed by Bank of Montreal. I have responsibility for the management of the loans and accounts made available by BMO and certain other lenders forming a syndicate¹ (together, the "**Lenders**") to Thane Direct Company ("**Thane Canada**") and Thane Direct, Inc. ("**Thane U.S.**") as borrowers (the "**Borrowers**") and as such have personal knowledge of the

¹ The members of the lending syndicate are Bank of Montreal, National Bank of Canada and HSBC Bank Canada

- 2 -

matters deposed herein, save and except where stated to be based on information and belief, in which case I do verily believe that information to be true.

Purpose and Overview

2. This Affidavit is made in support of an application by BMO in its capacity as syndication agent and administrative agent ("**BMO**" or the "**Agent**") for the Lenders, for an order appointing Richter Advisory Group Inc. as receiver of all of the assets, property and undertakings of the Respondents ("**Richter**") pursuant to Section 243 of the *Bankruptcy and Insolvency Act*, R.S.C. 1985, c. B-3 (the "**BIA**"), as amended, and Section 101 of the *Courts of Justice Act*, R.S.O. 1990, c. C-43 (the "**CJA**"), for the limited purposes and with the particular powers described in this Affidavit and more particularly outlined in the forms of order accompanying the notice of application herein.

3. In particular, BMO seeks the appointment of Richter in order to consummate a sale transaction (the "**Transaction**") whereby substantially all of the business (the "**Thane Business**") operated by the Respondents and certain of their affiliates (the "**Thane Group**") is acquired by a newly incorporated Canadian entity ("**New Thane Holdco**") and certain subsidiaries (together with New Thane Holdco, the "**New Thane Purchasers**"). The shares of New Thane Holdco will initially be owned indirectly by the two of the three existing Lenders to the Thane Group (BMO and National Bank of Canada), as to a minority interest, and certain

- 3 -

of the existing management team of the Thane Group, as to the remaining majority interest, all as is described in more detail below.

4. The New Thane Purchasers have offered to purchase the Thane Business for a purchase price of approximately US\$50 million, together with the assumption of most but not all of the existing contractual and trade creditor liabilities of the Thane Group and the payment of certain transaction costs. The purchase price is to be funded by way of financing to be provided to New Thane Holdco by the Lenders, and the cash proceeds of the transaction are to be immediately distributed by the Receiver and applied in reduction of the existing indebtedness owed by Thane Canada and Thane U.S. to the Lenders, which is currently approximately US\$96,744,756 plus substantial interest and costs (the "**Indebtedness**").
5. The Transaction and the offer to purchase by the New Thane Purchasers are conditional upon obtaining this Court's approval of the Transaction and ancillary relief from the U.S. Bankruptcy Court exercising its powers of recognition under Chapter 15 of the *U.S. Bankruptcy Code* with regard to property owned by those Respondents incorporated in and resident in the U.S..
6. The Thane Group is currently insolvent. Based on a thorough sale process undertaken by the Thane Group and its professional third party advisors, with the input of the Lenders, and based on the views of Ernst & Young Inc. as financial

- 4 -

advisor to the lenders, the assets and shares which are the subject of the Transaction are worth considerably less than the existing senior secured debt of approximately US\$96,744,756 plus substantial interest and costs.

7. In all the circumstances, approval of this Transaction will permit the Thane Business to continue and its suppliers and employees to have the benefit of continuing contracts and jobs and the purchase price represents fair value for the relevant assets and shares. The alternative to this Transaction, a liquidation, would result in recoveries of very substantially less than the value attributed to the Thane Business as a going concern in the context of the Transaction with the New Thane Purchasers. Based on the valuation information available to BMO, neither a liquidation or any alternative going concern sale of the Thane Business would come anywhere close to providing value sufficient to retire the Lender's properly perfected and senior secured loans and a liquidation would be likely to significantly increase the Lender's losses on their existing senior secured debt.

Business and Corporate Structure

8. The Thane Group operates a multi-national media and direct response business. The head office of the Thane Group is located at 5255 Orbitor Drive, Mississauga, Ontario.

- 5 -

9. The Thane Business focuses on the sale of unique consumer products. The Thane Group's business model takes consumer products through a product life cycle involving the following stages:
- (i) create or acquire project concept or ideas;
 - (ii) create prototype and prepare for showings of product;
 - (iii) market and media test product;
 - (iv) finalize product development and adjust product shows/advertising;
 - (v) launch product commercially;
 - (vi) early sales (direct multi-media sales or through traditional retail distribution);
 - (vii) peak sales;
 - (viii) sales decline (typically 18 to 36 months from project launch);
 - (ix) end of product life cycle or re-launch with augmented product features if possible.
10. The Thane Business is focused on development, marketing and distribution. The manufacturing of products developed by or for the Thane Group is done by third parties.
11. Products that are developed, marketed and sold by the Thane Group have a shorter life cycle than many consumer products. As indicated above, after a product's sales peak, sales may taper off quickly and decline, although in certain cases a post-peak product may be re-introduced with new features and updated branding.

- 6 -

12. Examples of Thane Group products include the X-5 Steam Mop and the Abtronic exercise product. In the past, the Thane Group accessed direct television advertising as an important tool for the marketing and sale of its products. In more recent years, Thane Group has moved to increase distribution through more traditional channels, including sales through major retailers and internet sales.
13. Thane Group carries on its business through a relatively complex corporate structure. Attached hereto as **Exhibit "A"** is a copy of the corporate organization chart for Thane Group as of July 1, 2015.
14. In the attached corporate organization chart, Thane Group companies specifically named as Respondents to the receivership ("**Thane Receivership Companies**") are shaded with diagonal cross-hatches. The Thane Group companies whose shares are proposed to be sold (as assets of the Thane Receivership Companies) are shaded with vertical cross-hatches. Certain of the Thane Receivership Companies are selling not only the shares of subsidiaries, but also assets. Where this is the case, it has been indicated by bolding the names of the relevant Thane Receivership Companies that are vending both shares and assets. Certain of the Thane Group Companies will not be acquired.
15. As illustrated by the organization chart, apart from two U.S. incorporated and resident subsidiaries of Thane International, Inc., Thane Direct, Inc. ("**TDI**") owns

- 7 -

the shares of all of the subsidiary companies (either directly or indirectly) involved in the Thane Business. In addition, TDI plays a critical role as a purchaser of the products supplied to the Thane Group companies active in the distribution of Thane Group products outside North America. Together with Thane Canada and Thane Direct Marketing Inc. ("**TDMI**"), TDI contracts with the manufacturers of products developed by or for the Thane Group who carry on their manufacturing activities in the Peoples Republic of China.

16. TDI, Thane Canada and TDMI supply product to Thane Group members active outside North America through two basic channels:
 - (a) Products are supplied to Thane Direct U.K. Ltd. for sale in the United Kingdom ("**Thane U.K.**"); to TVNS Scandinavia AB ("**Thane Scandinavia**") for sale in Scandinavia; to Grupo Mejor Compra SAPI de CV for sale in Mexico ("**Thane Mexico**"); and, to Danoz Direct Pty. Ltd. for sale in Australia ("**Thane Australia**"). Each of Thane U.K., Thane Scandinavia, Thane Mexico and Thane Australia (together, the "**Thane International Distributors**") distributes Thane Group products either through direct television, marketing or internet sales or through retail channels by supply to traditional retail businesses, including Walmart and other large format consumer goods outlets; and

- (b) Products are also supplied to third party distributors in countries in which the Thane Group does not have a distribution subsidiary. In these cases, third party distributors function like the Thane International Distributors (except there is no corporate ownership link between these third parties and the Thane Group) and sell Thane Group products either through direct television marketing, internet sales or local retail channels.
17. Sales in North America are organized differently than the international sales summarized above. In the United States, West Coast Direct Marketing, Inc. ("**West Coast**") is responsible for all direct television marketing sales and internet sales. Sales through retail channels in the United States are made through TDG, Inc. Both West Coast and TDG, Inc. source their product directly from the Chinese manufacturers who supply TDI, Thane Canada and TDMI.
18. Sales in Canada are made through Thane Direct Canada Inc. ("**TDCI**"). TDCI sells both through the direct television marketing and internet channels and through retail channels.
19. The intellectual property used in the Thane Business is largely comprised of trademarks and patents (both owned and licensed) relating to the products being distributed. Product is purchased from the Chinese manufacturers and supplied to Thane Group distribution companies, based on which of the Thane Group Companies holds the relevant trademark and patent rights. The intellectual

- 9 -

property rights effectively reside with the company within the Thane Group that has developed or acquired the relevant product concept.

20. Set out below is a summary of the critical Thane Group companies and their jurisdictions of incorporation and head office locations:

Thane Group Company	Jurisdiction of Incorporation	Head Office Location
Thane International, Inc.*	Delaware	El Segundo, California
Thane Direct, Inc.*	Delaware	Toronto
Thane Direct Company*	Nova Scotia (ULC)	Toronto
Thane Direct Marketing Inc.*	Ontario	Toronto
West Coast Direct Marketing, Inc.*	California	Canton, Ohio
TDG, Inc.*	Delaware	Canton, Ohio
Thane Direct Canada Inc.*	Ontario	Toronto
Thane Direct U.K. Ltd.	England	London
TVNS Scandinavia AB	Sweden	Malmö, Sweden
Grupo Mejor Compra SAPI de CV	Mexico	Mexico City
Danoz Direct Pty. Ltd.	Australia	Sydney

*Companies in the Thane Group within the receivership and selling either assets or shares under the terms of the Transaction.

Attached hereto as **Exhibit "B"** is a chart illustrating in graphic form the critical flows of supply, distribution and sales within Thane Group involving the corporations described above.

Financing and Secured Creditors

21. Pursuant to an Amended and Restated Credit Agreement dated as of September 28, 2012, as subsequently further amended (the "**Credit Agreement**"), between BMO as the Agent, BMO, HSBC Bank Canada and National Bank of Canada as the Lenders, Thane Canada and Thane U.S. as the Borrowers, Direct Marketing Holdings, Inc., Thane International, Inc., West Coast, TDG, Inc., TDCI and Thane Dutch Holdings Cooperatief E.A., as guarantors (the "**Guarantors**"), the Lenders made available to the Borrowers certain credit facilities as follows:

- (a) a revolving credit facility up to a maximum of US\$10 million or the Canadian dollar equivalent thereof, subject to applicable margin sub-limits (the "**Revolving Facility - Facility A**"); and
- (b) a term facility in the original principal amount of US\$100 million or the Canadian dollar equivalent thereof (the "**Term Facility - Facility B**", the Revolving Facility – Facility A and the Term Facility – Facility B are together, the "**Credit Facilities**").

Now shown to me and forming **Exhibit "C"** to my Affidavit is a true copy of the Credit Agreement and its amendments. Since it is voluminous, I have not attached a copy of the Credit Agreement to my Affidavit, but will make a copy of the said document available upon request, if required.

22. As security for the Borrowers' indebtedness to the Lenders under the Credit Agreement in respect of the Credit Facilities, Thane Group members provided the security summarized in the list attached as **Exhibit "D"** (the "**Security**"). The security for the indebtedness of the Borrowers includes the instruments and registrations usual and customary for credit facilities of this nature, and in particular the following:

- (a) Guarantees from West Coast, TDG, Inc., TDI, Thane International, Inc., Thane Canada, TDMI, TDCI, Thane Dutch Holdings Cooperatief E.A. ("**Thane Netherlands**") and Direct Marketing Holdings, Inc.;
- (b) Security agreements or general security agreements from West Coast, TDG, Inc., TDI, Thane International, Inc., Thane Canada, TDMI², TDCI and Direct Marketing Holdings, Inc.;
- (c) *Bank Act* security from TDCI; and
- (d) Share pledges from the relevant Thane Group parent companies of the shares of Thane Netherlands, Thane U.K., as to 65% of the issued shares, Thane Canada and Thane Mexico (as to the 80% of the issued shares of Thane Mexico owned by TDI); and,

² A guarantee and security agreement was recently given by TDMI in consideration of the Lenders' continued forbearance and as contemplated under the Credit Agreement.

- 12 -

- (e) certain ancillary security instruments.
23. The security interests created by the security were registered as required in the applicable registration systems for the relevant jurisdictions and perfected as against the collateral to which the said security interests apply. As I understand it, Borden Ladner Gervais LLP and Goulton & Storrs, respectively, the Canadian solicitors and U.S. attorneys for Richter in its capacity as proposed receiver in respect of the Respondents will opine that the Security is perfected where required and is valid and enforceable, subject to the qualifications and assumptions usual to opinions of this type and to certain specific comments made in these opinions. I further understand that details concerning these independent opinions on the security will form part of a pre-appointment report to be filed by Richter.
24. In addition to the senior secured claims of the Lenders, the Thane Group has very limited indebtedness to finance companies providing automobile financing to employees and executives of the company.
25. Thane Group also has ordinary course obligations to its employees (who are non-unionized in Canada and elsewhere), to governmental authorities in respect of tax and withholdings and to its suppliers. In the case of all of these liabilities, I am advised by Richter and believe (based on Richter's access to and review of the books and records of the Thane Group and discussions with its

management), that Thane Group is current on all required payments in respect of employee wages, vacation pay and benefits that are material; all amounts that are required to be remitted to governmental authorities, either by way of source deductions, commodity tax or otherwise; and, is paying suppliers in the ordinary course, in accordance with past practice.

26. As is set out in more detail below, it is the intention of the parties in connection with the Transaction that all obligations and liabilities to continuing employees and in respect of other claims by governmental authorities in relation to continuing employees which are not fulfilled at the time of closing shall be assumed by the New Thane Purchasers. It is my further understanding that substantially all liabilities in respect of trade suppliers shall be assumed by the New Thane Purchasers under the Transaction, such that there will be no material compromise of unsecured claims.
27. In addition to its debt financing, the Thane Group has been historically financed by significant equity investments. As at March, 2013, the majority shareholder of Thane was a private equity investor, H.I.G. Capital, which at that date held approximately 61% of the issued and outstanding shares. The next largest investor providing equity financing to Thane is the Hay family, prior owners of the Thane Business who hold approximately 28% of the issued and outstanding shares of Thane. Thane management employees currently hold approximately 7% of the outstanding shares of the company.

Financial Difficulties and Forbearance

28. Thane Group's earnings are very largely driven by the success of the products which the group develops. As indicated, these products have a relatively short and somewhat variable lifecycle during which they are saleable. Between 2008 and 2011, through a series of products, including the X-5 Steam Mop and the Abtronic exercise product, the Thane Group experienced a high degree of success with its developed products. Consequently, the group's earnings in these years peaked and were sustained over a longer period of time than had been anticipated. In the five years prior to the 2008-2011 period, annual adjusted earnings of the group before interest, taxes, depreciation, and amortization ("**EBITDA**") averaged approximately \$15 million per annum. In 2010, in contrast, EBITDA for the group was \$44 million. Similar levels of earnings were achieved in fiscal years 2012 and 2013, in the amount of approximately \$41 million.
29. With the concurrence of the Lenders, the shareholders of the Thane Group undertook a dividend recapitalization initiative in September of 2012 whereby the shareholders withdrew approximately \$70 million. This payment on account of equity had the effect of increasing the senior secured indebtedness owed to the Lenders to more than US\$100 million in the aggregate.
30. Beginning at the end of fiscal 2013 (March 31, 2013) as the highly successful Thane Group products started to suffer sales declines, earnings began to drop precipitously. In the period from April 1, 2013 to March 31, 2014, earnings fell

- 15 -

from approximately \$41 million in the prior period to \$16 million. As a result of these declines in earnings, in the early fall of 2013 the Thane Group advised the Agent that they anticipated that the Borrowers would be in breach of the relevant financial covenants under the Credit Agreement, in particular the covenants governing total funded debt to EBITDA and the minimum fixed charge coverage ratio. As well, the Borrowers advised the Agent that they would be unable to make a required installment repayment on account of the Term Facility – Facility B, due on or about September 30, 2013. In the event, the Borrowers were given an extension for the payment of this installment payment in the amount of \$3,750,000, to October 31, 2013 but, as at that date, the Borrowers remained unable to make the payment and in breach of their obligations under the Credit Agreement.

31. In the face of the Borrowers' defaults under the Credit Agreement and the Borrowers' failure to improve their working capital position through an injection of capital, the Agent and the Lenders entered into a Forbearance Agreement dated as of November 12, 2013 (the "**Forbearance Agreement**"). Attached hereto as **Exhibit "E"** is a true copy of the Forbearance Agreement.

32. In accordance with the Forbearance Agreement, the Borrowers and the Guarantors acknowledged the appointment of Ernst & Young as a consultant for the benefit of the Agent. The Forbearance Agreement also required the production of certain cash flow forecasts in relation to the Borrowers and

- 16 -

provided for a reduction in the credit limit for the Revolving Facility – Facility A, from \$10 million to \$8 million, subject to certain discretionary exceptions.

33. The Forbearance Agreement was amended on a number of occasions between December 2013 and the end of March, 2014. As a result of continuing deterioration in the performance of the business through fiscal 2014 and into fiscal 2015, the Forbearance Agreement was ultimately amended and restated as of May 26, 2014 (the “**Amended and Restated Forbearance Agreement**”), to provide for a number of amendments to the covenants and security rights in relation to the outstanding indebtedness of the Borrowers. The Amended and Restated Forbearance Agreement also attached a form of sale and investor solicitation process (the “**SISP**”) agreed to by the parties and required the Borrowers to observe and perform their covenants and obligations in relation to the SISP. Attached hereto as **Exhibit “F”** is a true copy of the Amended and Restated Forbearance Agreement, which has been extended from time to time and amended such that it remains in force as of the date of this Affidavit.
34. Overall, the Borrowers’ financial difficulties arose from the declines in revenues caused by an inability to replicate the success of their former products. While the Borrowers’ revenues declined in the face of falling sales, their fixed costs remained the same and they were unable to adapt their cost structure. These difficulties were exacerbated by the strain on working capital caused by the dividend recapitalization payment. Finally, the Thane Group has also suffered

- 17 -

from a shift in the market for the consumer goods sold by the group, which has seen sales from direct marketing television channels decline. Although the Thane Group has moved to increase distribution by accessing more traditional retail channels such as existing department stores, the product profit margins on sales through traditional retail channels are significantly narrower than television and multimedia sales.

Marketing and Sale Process

35. In accordance with the SISP, which the Thane Group agreed to implement in satisfaction of the requirements of the Amended and Restated Forbearance Agreement, Thane Group selected SSG Capital Advisors (“SSG”) as an investment advisor and began the process of canvassing the market for sale and/or refinancing options intended to maximize value for all stakeholders.
36. SSG commenced the SISP in mid-July of 2014.
37. In consultation with Ernst & Young Inc. and the Lenders, both strategic and financial parties likely to have an interest in the Thane Business were identified and contacted.
38. Although a significant number of the parties contacted entered into non-disclosure agreements and obtained a Confidential Information Memorandum

- 18 -

describing the details of the Thane Business, by the established bid deadline of September 26, 2014, only six letters of intent were received.

39. The letters of intent received included a letter of intent provided by Amir Tukulj and Russel Orelowitz on behalf of themselves and other members of the senior management of the Thane Group (the "**Management Shareholders**").
40. All of the Letters of Intent obtained in September 2014 through the SISP were expressed to be non-binding and valued the Thane Business based on a trailing 12-month calculation of EBITDA. The range of values presented was significantly less than the amount of the Lenders' Indebtedness. In addition, the trailing 12-month EBITDA of the Thane Group continued to decline through the period of the sales and investment process.
41. In view of the declining results during this time, and given the closing risks associated with what came down to only three interested parties other than the Management Shareholders, negotiations with the Management Shareholders commenced in November 2014 and have continued until well into 2015.
42. Ultimately, the Lenders and the Management Shareholders reached an agreement in principle for the purchase and sale of the Thane Business.

Proposed Sale Transaction

43. Following the process set out above, the Lenders and the Management Shareholders entered into a letter of intent dated May 22, 2015 concerning the acquisition of the Thane Business by the New Thane Purchasers and the rights and obligations of the Management Shareholders and the Lenders as equity holders in New Thane Holdco (the "**Letter of Intent**"). A copy of the Letter of Intent is attached as **Exhibit "G"**.
44. Although the parties have refined some of the terms of the Letter of Intent since it was entered into, the essence of the purchase and sale transaction which it documents remains the same. The key features of the Transaction are as follows:
- (a) The New Thane Purchasers have been incorporated as Canadian corporations (with the exception of a subsidiary of New Thane Holdco which has been incorporated in the U.K. to hold intellectual property and a Delaware incorporated subsidiary) to acquire the assets and shares making up the Thane Business;
 - (b) BMO and National Bank of Canada³ (the "**Participating Lenders**"), through an intermediary holding company, will hold a total of 35% of the

³ HSBC Bank Canada is a Lender and part of the syndicate participating in the Credit Facilities made available to the Thane Group, however, HSBC Bank Canada will not be an indirect shareholder of New Thane Holdco in the manner of BMO and National Bank of Canada. Instead, HSBC Bank Canada will

- 20 -

initial overall equity in New Thane Holdco (the "**Participating Lender Equity**");

- (c) The Management Shareholders will hold a total of 65% of the initial overall equity in New Thane Holdco;
- (d) The Participating Lenders and the Management Shareholders have finalized a Shareholders Agreement as of October 16, 2015 governing their rights and obligations as shareholders of New Thane Holdco (the "**Shareholders Agreement**") which includes, among other things, provision for reductions in the equity interest of the Participating Lenders upon certain repayment events in relation to the New Thane Term Loan (defined below) and for various control and sale rights and obligations, all in accordance with the detailed provisions of the Shareholders Agreement;
- (e) The New Thane Purchasers have delivered the Offer to Purchase dated October 16, 2015 (the "**Offer**") under which they offer to purchase the assets of the Thane Group and the shares of subsidiary companies which make up the Thane Business, for a cash purchase price of US\$50,000,000 plus the assumption by the New Thane Purchasers of the large majority of the unsecured liabilities of Thane Group and the payment

enter into an agreement with BMO and National Bank of Canada under which it will be entitled to monetary compensation based on an agreed percentage of any returns realized on the Participating Lender Equity.

- 21 -

of certain transaction costs, all in accordance with the detailed provisions of the Offer, a copy of which is attached hereto as **Exhibit "H"**;

- (f) Among other things, the Offer is conditional on approval by this Court and recognition and approval by a court of competent jurisdiction in the United States exercising jurisdiction under the U.S. Bankruptcy Code for the District of Delaware (the "**U.S. Bankruptcy Court**");
- (g) Among other things, the Offer is also conditional on approvals from the Office of the Superintendent of Financial Institutions permitting the Participating Lenders to hold their indirect equity ownership in New Thane Holdco⁴;
- (h) The Lenders (i.e.. including HSBC Bank Canada) intend to provide term financing to New Thane Holdco, conditional on the closing of the Transaction and on the terms of a credit agreement being negotiated with the Management Shareholders (the "**New Thane Credit Agreement**") under which the Lenders will advance the US\$50,000,000 cash purchase price to New Thane Holdco, on a fully secured and senior basis (the "**New Thane Term Loan**");

⁴ I am advised by David Cohen of Gowling Lafleur Henderson LLP, counsel to BMO and believe that the *Bank Act* (Canada) imposes a variety of restrictions on the ability of Canadian banks to hold equity interest, including limits on the periods of time during which an equity position can be held. The commercial basis for the Transaction and for the Participating Lenders' interest in the equity of New Thane Holdco requires that OSFI approve the ownership by the Participating Lenders of a "substantial interest" in New Thane Holdco for a period of more than 5 years.

- 22 -

- (i) The Participating Lenders (i.e. not including HSBC Bank Canada) also intend to provide operating financing to New Thane Holdco conditional on the closing of the Transaction and on the terms of the New Thane Credit Agreement, up to a maximum principal amount of US\$6,000,000, also on a senior secured basis (the “**New Thane Operating Loan**”); and,
- (j) The Management Shareholders have agreed to provide a term loan to New Thane Holdco in the amount of US\$2,000,000, pari passu with the New Thane Term Loan and on comparable terms and conditions but subordinate to the New Thane Operating Loan.
45. In addition to the purchase price referred to in paragraph 44 (e) above, the Offer specifies the assets and shares of the members of the Thane Group which will be acquired by the New Thane Purchasers. The chart below sets out what is being sold in relation to each of the Thane Receivership Companies:

<u>Thane Receivership Company</u>	<u>Assets/Shares Being Sold</u>	<u>Purchaser</u>
Thane International, Inc.	IP Assets	652134 Limited (“ New Thane IPCO (UK) ”)
	Other Assets	635427, Inc. (“ New Thane US ”)
Thane Direct, Inc.	Shares – 80% equity interest in Grupo Mejor Compra SAPI de CV	9472541 Canada Inc. (“ New Thane Holdco ”)
	Other Assets	New Thane Holdco

- 23 -

<u>Thane Receivership Company</u>	<u>Assets/Shares Being Sold</u>	<u>Purchaser</u>
Thane Direct Company	Shares: <ul style="list-style-type: none"> • Danoz Direct Pty Ltd. • TVNS Scandanavia AB • Thane Direct UK Ltd. 	New Thane Holdco
	IP Assets	New Thane IPCO (UK)
	Other Assets	9472550 Canada Inc. ("New Thane Canada")
	IP Licence with New Thane IPCO(UK)	New Thane Canada
Thane Direct Marketing Inc.	Shares: <ul style="list-style-type: none"> • Medio Latino Inc. • Thane USA, Inc. 	New Thane U.S.
	Other Assets	New Thane Canada
West Coast Direct Marketing, Inc.	Other Assets	New Thane U.S.
TDG, Inc.	Other Assets	New Thane U.S.
Thane Direct Canada Inc.	IP Assets	New Thane IPCO (UK)
	IP Licence with New Thane IPCO (UK)	New Thane Canada
	Other Assets	New Thane Canada

Note that in the foregoing chart "Other Assets" refers to any asset owned by a Thane Receivership Company except intellectual property assets, intellectual property licence rights pursuant to licences given to certain of the Thane Receivership Companies by New Thane IPCO (UK) as a closing step and

- 24 -

Excluded Assets described in the Offer. Other Assets can include Thane Group contractual rights, equipment, inventory and accounts receivable, as applicable.

46. Summarizing the shares and assets subject to the Offer and with reference to the corporate organization chart attached to this Affidavit as Exhibit "A", the Thane Group is selling all of its assets with the exception of:

- (a) the shares of each of the Thane Receivership Companies;
- (b) the shares and assets of Thane Dutch Holdings Coop;
- (c) the shares and assets of Thane Deutschland GmbH;
- (d) the shares and assets of TrendPro TV GmbH;
- (e) the shares and assets of Media Latino Source, Inc.; and,
- (f) the interests of the Thane Receivership Companies in a limited number of excluded contracts identified under the Offer.

47. As is set out in greater detail below, it is intended that the Thane Receivership Companies and those subsidiaries whose shares and assets are not being sold will be wound down following the completion of the Transaction. It is the intention of the parties that the liabilities for most unsecured creditors, including in particular trade suppliers, will be assumed either by operation of law through the

- 25 -

acquisition of the shares of the relevant Thane Group company or by assumption of the liabilities associated with assumed contracts in the case of the asset sale component of the Transaction. The New Thane Purchasers will not be assuming liability for any outstanding law suits or for liabilities associated with contracts specifically excluded from the transaction under the Offer.

48. On the basis of BMO's understanding that the Lenders have security over all of the assets and shares of the Thane Group which are the subject of the Transaction and the independent opinion to be given by counsel to Richter as proposed Receiver, BMO is asking this Court to approve this transaction involving these insolvent companies and their business.
49. Similarly BMO is requesting that this Court authorize Richter as receiver to make an immediate distribution of the cash purchase price paid by the New Thane Purchasers (which cash purchase price is being advanced by the Lenders under the New Thane Term Loan) as a payment on account of the Indebtedness. It is intended that this distribution be achieved by way of directions to be given on closing, which will have the effect of making the purchase a form of partial credit bid, as a practical matter.
50. If this Court approves the proposed Transaction and it closes following approval and recognition by the U.S. Bankruptcy Court, the Indebtedness owing to the Lenders will be reduced by approximately US\$50 million, leaving approximately

US\$48 million of the Indebtedness as an unsatisfied claim against Thane Group companies having negligible assets.

Receivership, Sale Approval and Recognition

51. As noted above, Thane Group is insolvent. Following the SISP run by SSG, an independent professional third party, it became apparent to the Lenders that the enterprise value of the Thane Business was very much less than the senior secured Indebtedness. In this context, and since the Lenders hold valid and enforceable senior security, the appointment of Richter as receiver for the purposes of consummating the Transaction contemplated by the Offer represents the best means of preserving value for the Lenders and preserving the enterprise for the greatest number of the stakeholders of the Thane Business.
52. In particular, by permitting a seamless transition of the business to new ownership and what amounts to a consensual compromise of the Indebtedness owed to the Lenders, the Transaction will cause minimum disruption to the business if approved.
53. Moreover, based on valuation evidence which has been prepared by Ernst & Young Inc. in its capacity as advisor to the Lenders, which I understand will appear as an exhibit to a pre-filing report to be delivered by Richter, the fair market value of the Thane Business, even on an enterprise valuation, is very much less than the value of the consideration being paid by the New Thane

Purchasers. With enterprise valuations noted by Ernst & Young Inc. in the range of US\$ [REDACTED] million to US\$ [REDACTED] million and liquidation valuations in the range of US\$ [REDACTED] million to US\$ [REDACTED] million (based on and subject to the detailed assumptions, qualifications and analysis contained in the Ernst & Young Inc. report) it appears clear that the Transaction contemplated under the Offer maximizes value.

54. The benefits to other stakeholders of the Thane Business lie in the fact that not only will the business continue but the bulk of the unsecured claims against the Thane Group will carry over to the New Thane Purchasers.
55. As indicated above in paragraph 20 of my Affidavit, of the seven Thane Receivership Companies, four of them are incorporated under U.S. state law. The other three Thane Receivership Companies are incorporated under Canadian provincial law. Notwithstanding the different jurisdictions of incorporation of the Thane Receivership Companies and the international character of the Thane Business, the mind and management of the Thane Business resides in Canada. At an operational level, the executives of the Thane Business maintain their presence in the Mississauga head office of the business and the critical members of the Thane Group, including Thane Direct, Inc. and Thane Direct Company, carry on their businesses from the Mississauga location. Further, the Credit Facilities provided by the Lenders to the Thane Group were negotiated and are administered by the Lenders in Toronto.

56. Notwithstanding that the Thane Group is centered in Southern Ontario, given its assets in the U.S., and the jurisdiction of incorporation of certain of the Thane Receivership Companies, it is a condition of the Offer that any order approving the Transaction and the Offer be recognized by the U.S. Bankruptcy Court in accordance with what I understand to be proceedings provided for under Chapter 15 of the U.S. Bankruptcy Code. In order to facilitate this, the Lenders are asking that this Court seek the assistance of the U.S. courts and appoint Richter as Receiver as the authorized representative of the Thane Receivership Companies for the purposes of the contemplated Chapter 15 proceedings.
57. In the Application being brought by the Lenders, the power to make assignments in bankruptcy in respect of the Thane Receivership Companies is also being sought in favour of the Receiver. This power is important to the Transaction since the Thane Receivership Companies will be largely shells following closing, with few or no significant assets. The Thane Receivership Companies will still have debt in excess of US\$50 million.
58. As a result of what I understand to be the processes and procedures required under the U.S. Bankruptcy Code, there will be a period of several weeks between any approval order which this Court sees fit to make, and any corresponding recognition and approval order which the U.S. Bankruptcy Court sees fit to make. During this time, the Thane Group will remain in possession and control of its business and will be preparing for the transition to ownership by the New Thane

Purchasers. In order to bring finality to the Transaction, following the making of any recognition and approval order which the U.S. Bankruptcy Court sees fit to make and after closing, it is intended that Richter in its capacity as receiver make assignments in bankruptcy in respect of the Thane Receivership Companies.

59. Overall, the receivership contemplated by this Application is intended to facilitate the sale of the assets comprising the Thane Business outside the ordinary course but to otherwise interfere as little as possible with the business so as to preserve its continuity and its value.
60. It is the Lenders' hope that through this Transaction and the receivership by which the Lenders seek to implement it, a significant business can be preserved for the benefit of those that rely on it. As a measure of the Lenders' confidence in the business, the decision has been taken to participate as indirect shareholders and the Lenders hope that this fact provides this Honourable Court with a measure of assurance that the Transaction is the best option for the Thane Group, the Lenders and other stakeholders.

61. I swear this affidavit in support of an application by BMO in its capacity as syndication agent and administrative agent for a syndicate of lenders for an order appointing Richter as receiver to convey the assets, property and undertakings of the Respondents and for related relief, and for no other or improper purpose.

SWORN before me at the City of Toronto, in the Province of Ontario, on the 16th day of October, 2015.



Commissioner for Taking Affidavits

Clifton P. Prophet



PAUL FINDLAY

TAB A

THIS IS EXHIBIT "A"
TO THE AFFIDAVIT OF PAUL FINDLAY
SWORN BEFORE ME THIS 16TH DAY
OF OCTOBER, 2015.



A Commissioner for Taking Affidavits

Clifton P. Prophet

DIRECT MARKETING HOLDINGS, INC. – OCTOBER 1, 2015

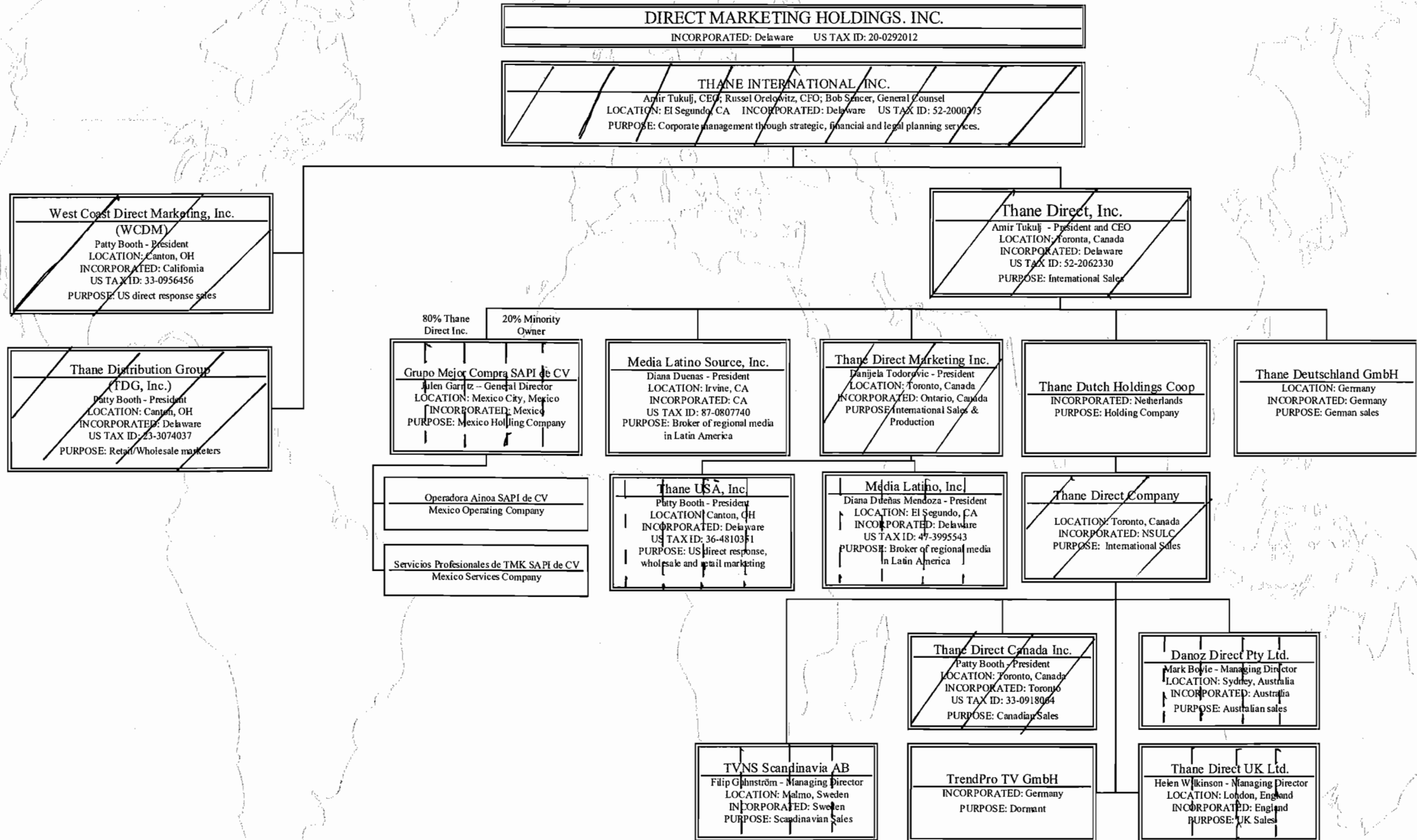

TAB B

THIS IS **EXHIBIT "B"**
TO THE AFFIDAVIT OF **PAUL FINDLAY**
SWORN BEFORE ME THIS 16TH DAY
OF OCTOBER, 2015.



A Commissioner for Taking Affidavits

Clifton P. Prophet

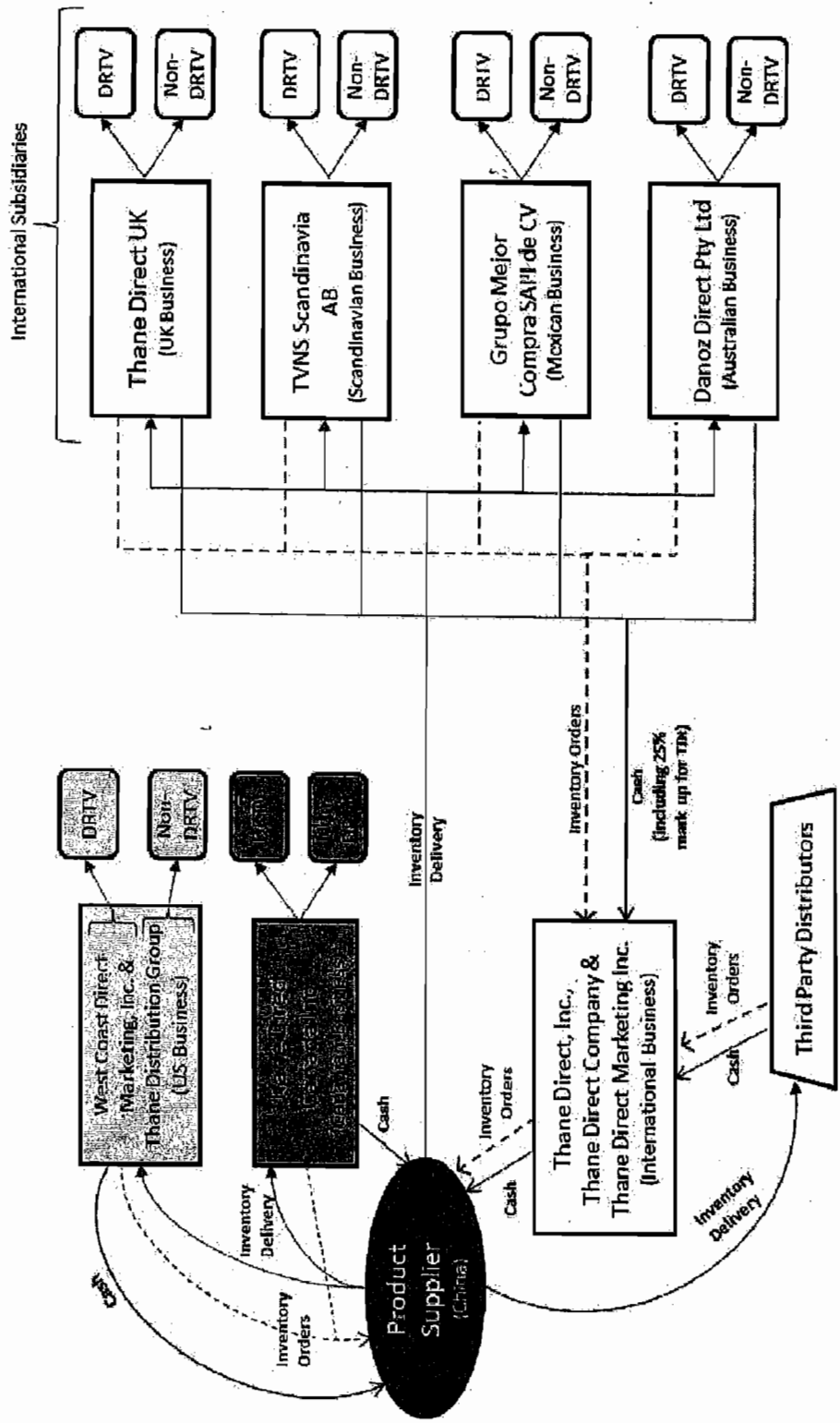

TAB C

THIS IS **EXHIBIT "C"**
TO THE AFFIDAVIT OF **PAUL FINDLAY**
SWORN BEFORE ME THIS 16TH DAY
OF OCTOBER, 2015.



A Commissioner for Taking Affidavits

Clifton P. Prophet

(This exhibit shown to witness but not attached due to volume.)

TAB D

THIS IS EXHIBIT "D"
TO THE AFFIDAVIT OF PAUL FINDLAY
SWORN BEFORE ME THIS 16TH DAY
OF OCTOBER, 2015.



A Commissioner for Taking Affidavits

Clifton P. Prophet

LIST OF SECURITY

1. Guaranty by West Coast Direct Marketing, Inc. ("**West Coast**"), TDG, Inc. ("**TDG**"), Thane Direct, Inc. ("**Thane Direct US**"), Thane International, Inc. ("**Thane International**") and Direct Marketing Holdings, Inc. ("**Parent**") dated as of December 22, 2010 in favour of Bank of Montreal, as administrative agent (the "**Agent**").
2. Security Agreement between West Coast, TDG, Thane Direct US, Thane International and Parent and the Agent dated as of December 22, 2010.
3. Share Pledge Agreement between Thane Direct US, as pledgor, and the Agent re shares of Grupo Mejor Compra, S.A.P.I. de C.V. ("**Grupo**") dated December 22, 2010.
4. Agreement and Deed of Pledge of Cooperative Membership Rights between Thane Direct US and Thane International, as pledgors, and the Agent, as pledge, re membership rights of Thane Dutch Holdings Coöperatief U.A. ("**Thane Netherlands**") dated December 22, 2010.
5. Guarantee by Thane Direct Company ("**TDC**") dated as of December 22, 2010 in favour of the Agent.
6. General Security Agreement between TDC and the Agent dated as of December 22, 2010.
7. Share Charge between TDC, as chargor, and the Agent dated December 22, 2010 re: shares of Thane Direct UK Limited ("**Thane UK**").
8. Guarantee by Thane Netherlands dated as of December 22, 2010 in favour of the Agent.
9. Pledge Agreement between Thane Netherlands and the Agent dated as of December 22, 2010 re: shares of TDC.
10. Guarantee by Thane Direct Canada Inc. ("**Thane Canada**") dated as of December 22, 2010 in favour of the Agent.
11. General Security Agreement between Thane Canada and the Agent dated as of December 22, 2010.
12. Notice of Intention under Section 427 of the *Bank Act* from Thane Canada in favour of the Agent dated December 21, 2010.
13. Application for Credit and Promise to Give Bills of Lading, Warehouse Receipts, or Security under Section 427 of the *Bank Act* from Thane Canada in favour of the Agent dated December 22, 2010.
14. Special Security Agreement under Section 427 of the *Bank Act* from Thane Canada in favour of the Agent dated December 22, 2010.

15. Agreement as to Loans and Advances and Security therefor under Section 427 of the *Bank Act* from Thane Canada in favour of the Agent dated December 22, 2010.
16. Assigned Account Agreement between Bank of Montreal and Thane Direct US, accepted by BMO Harris Bank N.A. on September 28, 2012.
17. Assigned Account Agreement between Bank of Montreal and Thane Direct Company, accepted by BMO Harris Bank N.A. on September 28, 2012.
18. Assignment of Account Receivable Insurance from Atradius Trade Credit Insurance, Inc. together with direction to pay documents as applicable dated December 15, 2010.
19. Warehouse Bailment addressed to Northland Fulfillment from Thane Canada, the Agent and RBC, acknowledged by Northland Fulfillment dated December 23, 2010, together with Fulfillment Center Agreement addressed to the Agent and RBC from Thane International, acknowledged and agreed to by the Agent, RBC and Innotrac Corporation dated December 23, 2010.
20. Irrevocable Proxy Coupled with Interest for each of
 - (a) Thane Netherlands dated June 4, 2014;
 - (b) Thane International dated June 3, 2014;
 - (c) Parent dated June 3, 2014;
 - (d) TDC dated June 3, 2014; and
 - (e) Thane Direct US dated June 3, 2014.
21. Guarantee by Thane Direct Marketing Inc. (“**TDMI**”) dated as of October 7, 2015 in favour of the Agent.
22. General Security Agreement between TDMI and the Agent dated as of October 7, 2015.

TAB E

THIS IS EXHIBIT "E"
TO THE AFFIDAVIT OF PAUL FINDLAY
SWORN BEFORE ME THIS 16TH DAY
OF OCTOBER, 2015.



A Commissioner for Taking Affidavits

Clifton P. Prophet



EXECUTION VERSION

FORBEARANCE AGREEMENT

BETWEEN:

THANE DIRECT COMPANY and THANE DIRECT, INC.

(as Borrowers)

- and -

**BANK OF MONTREAL, NATIONAL BANK OF CANADA, HSBC BANK CANADA
AND SUCH OTHER LENDERS AS MAY BECOME PARTIES HERETO**

(as Lenders)

- and -

BANK OF MONTREAL

(as Co-Lead Arranger, Syndication Agent, and Administrative Agent)

- and -

HSBC BANK CANADA

(as Co-Lead Arranger and Documentation Agent)

- and -

CERTAIN AFFILIATES OF THE BORROWERS

(as the other Credit Parties)

NOVEMBER 12, 2013

TABLE OF CONTENTS

	Page
ARTICLE 1	INTERPRETATION..... 2
1.1	Credit Agreement Definitions..... 2
1.2	Other Definitions 2
1.3	Entire Agreement..... 3
1.4	Business Day..... 3
1.5	Certain Rules of Interpretation..... 3
1.6	Schedules 4
ARTICLE 2	ACKNOWLEDGMENTS 4
2.1	Acknowledgement of Obligations 4
2.2	Other Confirmations and Acknowledgements..... 5
2.3	Additional Acknowledgements of Guaranteeing Entities..... 7
2.4	Consent of Borrowers and other Credit Parties 7
ARTICLE 3	FORBEARANCE IN RESPECT OF CERTAIN EVENTS OF DEFAULT 7
3.1	Forbearance..... 7
3.2	No Other Waivers; Reservation of Rights 9
3.3	Fees 9
3.4	Interest Rates..... 9
ARTICLE 4	AMENDMENTS TO CREDIT AGREEMENT 10
4.1	Amendment to Credit Agreement..... 10
4.2	Facility A Limit..... 10
4.3	UK Security 10
4.4	Nature of Amendment..... 11
ARTICLE 5	OBLIGATIONS OF THE CREDIT PARTIES DURING FORBEARANCE PERIOD..... 11
5.1	Covenants of the Borrowers and other Credit Parties..... 11
5.2	Joint Covenants of the Credit Parties..... 12
5.3	Additional Covenants..... 14
ARTICLE 6	EXISTING SECURITY..... 14
ARTICLE 7	OBLIGATIONS OF THE AGENT DURING THE FORBEARANCE PERIOD 14
7.1	Additional Loans..... 14
ARTICLE 8	REPRESENTATIONS, WARRANTIES AND COVENANTS 15
8.1	Representations in Loan Documents 15
8.2	Full Effect of Documents..... 15
8.3	No Conflict..... 15

TABLE OF CONTENTS
(continued)

		Page
8.4	No Material Adverse Effect.....	15
8.5	Terminating Events.....	15
ARTICLE 9	CONDITIONS TO EFFECTIVENESS OF CERTAIN PROVISIONS OF THIS AGREEMENT	17
9.1	Conditions to Effectiveness of Certain Provisions	17
ARTICLE 10	GENERAL	17
10.1	Effect of this Agreement.....	17
10.2	Costs and Expenses.....	18
10.3	Survival of Representations and Warranties.....	18
10.4	Reviewed by Legal Counsel	18
10.5	Governing Law	19
10.6	Submission to Jurisdiction	19
10.7	Mutual Waiver of Jury Trial	19
10.8	Time of Essence.....	19
10.9	Notices	20
10.10	Further Assurances.....	20
10.11	Amendment and Waiver	20
10.12	Assignment and Enurement	20
10.13	Severability	20
10.14	Counterparts.....	21
10.15	Facsimile Signatures	21

FORBEARANCE AGREEMENT

THIS AGREEMENT is dated as of November 12, 2013

B E T W E E N :

THANE DIRECT COMPANY and THANE DIRECT, INC., as Borrowers

– and –

BANK OF MONTREAL, NATIONAL BANK OF CANADA, HSBC BANK CANADA AND SUCH OTHER LENDERS AS MAY BECOME PARTIES HERETO, as lenders

– and –

BANK OF MONTREAL, as Co-Lead Arranger, Syndication Agent, and Administrative Agent

– and –

HSBC BANK CANADA, as Co-Lead Arranger and Documentation Agent

– and –

CERTAIN AFFILIATES OF THE BORROWERS, as the other Credit Parties

CONTEXT:

- A. The Agent, the Lenders, and the Borrowers have entered into certain financing arrangements under an Amended and Restated Credit Agreement dated as of September 28, 2012 between, *inter alia*, the Agent, the Lenders, and the Borrowers (as may be amended, restated, revised, modified, renewed and/or replaced from time to time, the “Credit Agreement”).
- B. As of the date of this Agreement, the Borrowers are in default under the Credit Agreement and the other Loan Documents which defaults constitute one or more Events of Default under the Loan Documents.

- C. The Borrowers have requested that the Agent, for and on behalf of itself and the Lenders, continue to forbear from exercising its rights as a result of the Existing Defaults, which are continuing, and that the Lenders provide further advances under Facility A and other financial accommodations to the Borrowers despite those Events of Default.
- D. The Agent and the Lenders are willing to forbear from exercising certain of their rights and remedies and to provide certain further Loans to the Borrowers for the Forbearance Period on the terms and conditions set out in this Agreement.

THEREFORE, the Parties agree as follows:

ARTICLE 1 INTERPRETATION

1.1 Credit Agreement Definitions

Each capitalized term used and not otherwise defined in this Agreement will have the meaning assigned to it in the Credit Agreement.

1.2 Other Definitions

In this Agreement the following terms have the following meanings:

- 1.2.1 “**Additional Events of Default**” means any Event of Default which is existing as of the date of this Agreement but is unknown to the Agent or which may occur on or after the date of this Agreement.
- 1.2.2 “**Agreement**” means this agreement, including all Schedules and Exhibits, as it may be supplemented or amended by written agreement between the Parties.
- 1.2.3 “**Cash Flow**” is defined in Section 2.2.5.3.
- 1.2.4 “**Communication**” means any notice, demand, request, consent, approval, or other communication which is required or permitted by this Agreement to be given or made by a Party.
- 1.2.5 “**CCAA**” means the *Companies’ Creditors Arrangements Act (Canada)*.
- 1.2.6 “**Consultant**” is defined in Section 2.2.5.
- 1.2.7 “**Consulting Engagement**” is defined in Section 2.2.5.
- 1.2.8 “**Credit Agreement**” is defined under “Context”, above.
- 1.2.9 “**Existing Defaults**” means the Defaults and Events of Default that have occurred to the date of this Agreement as more particularly identified in Schedule 1.

- 1.2.10 **“Existing Security”** means the security described in Schedule 2 to this Agreement, as the same may be amended, restated, modified, supplemented, and/or replaced from time to time.
- 1.2.11 **“Forbearance Period”** is defined in Section 3.1.1.
- 1.2.12 **“Forecast”** is defined in 2.2.5.2.
- 1.2.13 **“Terminating Event”** is defined in Section 8.5.
- 1.2.14 **“UK Security”** is defined in Section 4.3.1.

1.3 Entire Agreement

This Agreement is a Loan Document and, together with the other Loan Documents and the agreements and other documents to be delivered pursuant to or in connection with this Agreement, constitute the entire agreement between the Parties pertaining to the subject matter of this Agreement and supersedes all prior agreements, understandings, negotiations and discussions, whether oral or written, of the Parties, and there are no representations, warranties or other agreements between the Parties in connection with the subject matter of this Agreement except as specifically set out in this Agreement, the other Loan Documents or the other agreements and documents delivered under this Agreement.

1.4 Business Day

Whenever any payment to be made or action to be taken under this Agreement is required to be made or taken on a day other than a Business Day, the payment is to be made or action taken on the next Business Day following.

1.5 Certain Rules of Interpretation

- 1.5.1 In this Agreement, words signifying the singular number include the plural and vice versa, and words signifying gender include all genders. Every use of the word “including” in this Agreement is to be construed as meaning “including, without limitation”.
- 1.5.2 The division of this Agreement into Articles and Sections, the insertion of headings and the provision of a table of contents are for convenience of reference only and do not affect the construction or interpretation of this Agreement.
- 1.5.3 References in this Agreement to an Article, Section, Schedule or Exhibit are to be construed as references to an Article, Section, Schedule or Exhibit of or to this Agreement unless the context requires otherwise.
- 1.5.4 Unless otherwise specified in this Agreement, time periods within which or following which any payment is to be made or act is to be done will be calculated by excluding the day on which the period commences and including the day on which the period

ends. If the last day of a time period is not a Business Day, the time period will end on the next Business Day.

- 1.5.5 Unless otherwise specified, any reference in this Agreement to any statute includes all regulations made under that statute, and is to be construed as a reference to that statute as amended, supplemented or replaced from time to time.

1.6 Schedules

The following is a list of Schedules and Exhibits:

Schedule	Subject Matter	Section Reference
Schedule 1	Existing Defaults	1.2.9
Schedule 2	Existing Security	1.2.11
Schedule 3	Accounts	5.2.4

ARTICLE 2 ACKNOWLEDGMENTS

2.1 Acknowledgement of Obligations

The Borrowers and each other Credit Party acknowledges and agrees that the Outstanding Advances as of November 8, 2013 are as follows:

2.1.1 Facility A:

- 2.1.1.1 Aggregate Indebtedness in U.S. dollars in the amount of US\$5,340,000 plus applicable interest at US Base Rate of 5.75% plus 2% default interest rate.

2.1.2 Facility B:

- 2.1.2.1 Tranche 1 - Aggregate Indebtedness in U.S. dollars in the amount of US\$55,912,500 plus the applicable LIBOR at 4.5% plus 2% default interest rate ; and
- 2.1.2.2 Tranche 2 – Aggregate Indebtedness in U.S. dollars in the amount of US\$32,837,500 plus the applicable LIBOR at 4.5% plus 2% default interest rate.

2.1.3 Swingline Facility:

- 2.1.3.1 the aggregate amount outstanding under the Swingline Facility is US\$233,230.72 plus applicable interest.

The foregoing amounts are not inclusive of any US\$ amounts on deposit with Bank of Montreal and/or BMO Harris Bank and do not account for cheques in the float as at November 8, 2013.

2.2 Other Confirmations and Acknowledgements

As of the date of this Agreement, each of the Borrowers and each other Credit Party confirms, acknowledges and agrees that:

- 2.2.1 the Existing Defaults have occurred and are continuing, each of which constitutes an Event of Default under the Loan Documents and the Borrowers further represent and warrant that as of the date of this Agreement no other Events of Default under the Loan Documents exist. The Agent has not waived the Existing Defaults and nothing contained in this Agreement or the transactions contemplated by this Agreement will be deemed to constitute any such waiver;
- 2.2.2 the Borrowers are unable to pay the Outstanding Obligations in full within a reasonable period of time;
- 2.2.3 interest and fees continue to accrue on the Outstanding Obligations under the Loan Documents at the rates applicable to the Outstanding Obligations as specified in the Loan Documents (including this Agreement);
- 2.2.4 as a result of the Existing Defaults, the Borrowers acknowledge and agree that, absent the existence of this Agreement, the Agent would have the right to demand immediate payment of the Outstanding Obligations under the Credit Agreement and the other Loan Documents and immediately terminate the Credit Facilities;
- 2.2.5 Ernst & Young LLP (the "**Consultant**") has been, or concurrently with the execution of this Agreement will be, engaged by the Agent (or the Agent's legal counsel) on behalf of the Lenders, and at the sole expense of the Borrowers, as financial advisor to the Agent and the Lenders, in accordance with the terms and conditions of an engagement letter between the Consultant, Gowling Lafleur Henderson LLP as agent for the Agent and the Agent (the "**Consulting Engagement**"). The scope, terms, and conditions of the engagement of the Consultant shall be documented in an agreement in form and substance satisfactory to the Agent and the Consultant and the scope of the Consultant's retainer with the Agent shall include, but not be limited to, the following:
 - 2.2.5.1 The Consultant shall conduct a full financial analysis of the Borrowers and the other Credit Parties in anticipation of developing a recapitalization plan and/or detailed restructuring plan;
 - 2.2.5.2 The Consultant shall assist the Borrowers and the other Credit Parties in the preparation of a detailed and delineated 15-month cash flow forecast (the "**Forecast**") covering the period from December 1, 2013 through to March 31, 2015, such Forecast to be delivered to the Agent and the Lenders by no later than November 25, 2013, and such Forecast shall be

satisfactory to the Agent and the Lenders in their sole and unfettered discretion;

- 2.2.5.3 The Consultant shall assist the Borrowers and the other Credit Parties in the preparation of a 13-week cash flow (the "Cash Flow") covering the period from November 30, 2013 through to March 3, 2014, such Cash Flow to be delivered to the Agent and the Lenders by no later than December 2, 2013, and such Cash Flow shall be satisfactory to the Agent and the Lenders in their sole, absolute, and unfettered discretion;
- 2.2.5.4 The Consultant shall recommend measures to conserve working capital;
- 2.2.5.5 The Consultant shall act as the financial advisor to the Agent and the Lenders;
- 2.2.5.6 The Consultant shall have the authority to: (A) respond to all questions from the Agent to the Consultant; and (B) disclose all information, data reviewed and considered by the Consultant and provide all reports, opinions, and views of the Consultant to the Agent (for and on behalf of itself and the Lenders) on a confidential basis. The Borrowers and the other Credit Parties shall not be entitled to any of the reports, opinion, and views of the Consultant to the Agent save and except that the Borrowers and the other Credit Parties may see draft reports (timing permitting) as contemplated in the Consulting Engagement, provided that any and all such draft reports shall be redacted to exclude all views, recommendations, conclusions and opinions of the Consultant;
- 2.2.5.7 The Consultant, acting reasonably, shall have the ability to disclose to the Agent (for and on behalf of itself and the Lenders) on a confidential basis any financial and operational information relating to the Borrowers and the other Credit Parties, including, without limitation, matters relating to the Forecast, the Cash Flow, the Borrowing Base, Priority Payables and related information, all in respect of the Borrowers and the other Credit Parties;
- 2.2.5.8 The Consultant shall review any factoring arrangements proposed by the Borrowers, within the context of its overall financial analysis of the Borrowers, and the Lenders will consider such factoring arrangements thereafter;
- 2.2.5.9 The Borrowers and each other Credit Party agree to grant all reasonable access and provide all reasonable information and documentation to, and to otherwise co-operate with and pay all fees and disbursements provided for in the Consulting Engagement of, the Consultant;
- 2.2.5.10 The Borrowers and each other Credit Party consents to the Consulting Engagement on the terms and conditions set out therein.

- 2.2.6 it will not make any claims or bring any action against the Agent, the Lenders or their legal counsel in connection with or arising from the Consulting Engagement;
- 2.2.7 the Borrowers have paid, or will cause to be paid when due, all Priority Payables;
- 2.2.8 the Agent, for and on behalf of itself and the Lenders, has and will continue to have valid, enforceable, and perfected first-priority liens, mortgages, charges, and security interests upon and security interests in the Collateral (subject to Permitted Encumbrances) granted to the Agent, for and on behalf of itself and the Lenders, under the Security;
- 2.2.9 subject to any reservations or qualifications contained in any legal opinion previously delivered to the Agent, each of the Loan Documents to which the Agent, for and on behalf of itself and the Lenders, is party and this Agreement constitute legal, valid, and binding obligations of such Borrowers or the other Credit Parties, enforceable against it in accordance with their respective terms;
- 2.2.10 the Borrowers and/or the other Credit Parties do not have any valid claim for set-off, counter-claim, damages or other defence on any basis whatsoever against the Agent or any of the Lenders in respect of the Loan Documents and if there are any such claims, then it hereby expressly waives and forever releases the Agent and Lenders therefrom; and
- 2.2.11 subject to Applicable Law and the terms of this Agreement, the Agent and the Lenders are and will be entitled to the rights, remedies, and benefits provided for in the Loan Documents, this Agreement, and under Applicable Law.

2.3 Additional Acknowledgements of Guaranteeing Entities

As of the date of this Agreement, each Guaranteeing Entity acknowledges that:

- 2.3.1 its Guarantee has not been released, waived, or varied;
- 2.3.2 it consents to each of the Borrowers entering into this Agreement and acknowledges and confirms all representations and warranties, confirmations, obligations, and covenants of the Borrowers set out in this Agreement; and
- 2.3.3 to the extent that it is applicable or advisable, it has obtained independent legal advice.

2.4 Consent of Borrowers and other Credit Parties

Each of the Borrowers and each of the other Credit Parties acknowledges and consents to, if ever and whenever applicable, the future appointment of Ernst & Young LLP as monitor, receiver, trustee in bankruptcy, proposal trustee, liquidator or other Court-appointed restructuring officer or agent pursuant to the BIA, CCAA, or otherwise.

ARTICLE 3
FORBEARANCE IN RESPECT OF CERTAIN EVENTS OF DEFAULT

3.1 Forbearance

3.1.1 In reliance upon the acknowledgments, confirmations, representations, warranties, and covenants of the Credit Parties contained in this Agreement, and subject to the terms and conditions of this Agreement and any documents or instruments executed pursuant to or in connection with this Agreement, each of the Agent and the Lenders agrees to forbear from exercising its rights and remedies under the Loan Documents and/or Applicable Laws in respect of or arising out of the Existing Defaults for the period (the "**Forbearance Period**") commencing on the date of this Agreement and ending on the earlier of:

3.1.1.1 5:00 pm EST on Monday, December 16, 2013; and

3.1.1.2 the occurrence or existence of any Terminating Event.

3.1.2 Subject to any extension that may be provided pursuant to Section 3.1.3 below, upon the termination of the Forbearance Period, the agreement of the Agent and the Lenders to forbear will automatically and without further action terminate and be of no force and effect, it being expressly agreed that the effect of that termination will be to permit the Agent, for and on behalf of the Lenders, to exercise all or any part of its rights and remedies immediately, including, without limitation, under the Loan Documents, subject to Applicable Law and the terms and conditions of the Loan Documents, including:

3.1.2.1 To immediately terminate each of the Credit Facilities;

3.1.2.2 To cease to make any further Advances without any further notice, passage of time or forbearance of any kind;

3.1.2.3 To accelerate all of the obligations under the Credit Facilities, the Credit Agreement and the other Loan Documents and to enforce all its rights under the Loan Documents; and

3.1.2.4 applying to the Court for the appointment of a receiver, receiver manager, interim receiver or liquidation or, privately appointing a receiver and manager or receiver under any and all applicable Federal, Provincial, State or other laws of Canada, the United States or any and all other jurisdiction where the Borrowers or any other Credit Party has assets or carries on business in any way.

3.1.2.5 apply for a creditor initiated application under the CCAA.

3.1.3 Provided the Agent has received the Forecast and the Cash Flow in accordance with the timelines prescribed in this Agreement, in each case satisfactory to the Agent in

its sole, absolute, and unfettered discretion, the Agent and the Lenders will consider extending the Forbearance Period to provide the Borrowers and the other Credit Parties sufficient time to regularize their business on such terms and conditions as are acceptable to the Agent and the Lenders. For greater certainty, nothing in this Section 3.1.3 should be construed as requiring the Agent and the Lenders to extend the Forbearance Period.

3.2 No Other Waivers; Reservation of Rights

Neither the Agent nor any Lender has waived, nor by the entering into of this Agreement, is waiving, any Existing Defaults or Additional Events of Default (whether the same or similar to the Existing Defaults or otherwise). Neither the Agent nor any Lender has agreed to forbear with respect to any of its rights or remedies concerning any Existing Defaults or Additional Events of Default (other than, during the Forbearance Period, the Existing Defaults to the extent expressly set out in this Agreement), which may have occurred or are continuing as of the date of this Agreement or which may occur after the date of this Agreement. Neither the Agent nor any Lender has waived any of such rights or remedies, and nothing in this Agreement, and no delay on its part in exercising any such rights or remedies, should be construed as a waiver of those rights or remedies.

3.3 Fees

In consideration of the agreements set out in this Agreement, the Borrowers will pay to the Agent, for and on behalf of itself and the Lenders, the following fees:

- 3.3.1 a forbearance fee with respect to the Forbearance Period in the aggregate amount of \$125,000.00 which will be payable to each of the Lenders, according to each Lender's Proportionate Share, on November 13, 2013; and
- 3.3.2 a monthly monitoring fee in the aggregate amount of \$10,000.00 per month which will be payable to each of the Lenders, according to each Lender's Proportionate Share, in respect of the Lenders' services for each month (or part thereof) while this Agreement remains in effect and for as long after that as any of the liabilities or obligations under the Credit Agreement or the other Loan Documents are outstanding; which fee will be fully earned as of and payable in advance on the date of this Agreement and on the first day of each month after that.

The foregoing fees are in addition to all other fees, interest, costs and expenses payable in connection with the Loan Documents, the Consultant, or otherwise, and may be charged by the Agent to any account of the Borrowers maintained by the Agent. The fees will be fully earned by the Agent despite any failure by any Credit Party to comply with any other term of this Agreement.

3.4 Interest Rates

- 3.4.1 During the Forbearance Period and thereafter at all times unless and until all Defaults and/or Events of Default have been cured to the satisfaction of the Agent and the Lenders, the Applicable Margin in respect of each of the Credit Facilities, which is adjusted from time to time in accordance with the provisions of the Credit Agreement, shall have added to it the additional two percent (2%) per annum default interest rate contemplated under section 16.3 of the Credit Agreement.

ARTICLE 4 AMENDMENTS TO CREDIT AGREEMENT

4.1 Amendment to Credit Agreement.

- 4.1.1 The definition of "Facility A Limit" in Section 1.1.83 of the Credit Agreement is amended by deleting "10,000,000" from the first line of the definition and inserting the amount of "8,000,000" instead.
- 4.1.2 Section 14.1.5 of the Credit Agreement is amended by inserting "only" after "all Advances" in the first line.

4.2 Facility A Limit

- 4.2.1 Upon receipt of the final Cash Flow acceptable to the Agent and the Lenders, the Agent and the Lenders will review the Facility A Limit with the Borrowers and thereafter the Agent and the Lenders may agree, in their sole discretion, to increase the Facility A Limit.

4.3 UK Security

- 4.3.1 The Borrowers shall use its best commercial efforts to cause Thane Direct UK Limited to forthwith execute and deliver the following agreements and security (collectively, the "UK Security"):
- 4.3.1.1 a guarantee and postponement of debts and claims issued by Thane Direct UK Limited in favour of the Agent in respect of all Outstanding Obligations of the Borrowers;
 - 4.3.1.2 a debenture executed by Thane Direct UK Limited in favour of the Agent creating a first ranking Security Interest (subject to Permitted Encumbrances) in all present and after-acquired personal property of Thane Direct UK Limited, including without limitation, a pledge in favour of the Agent in respect of all present and future Equity Securities owned in respect of its current Subsidiaries and of all after-acquired Subsidiaries it may have from time to time accompanied by:

4.3.1.2.1 in the case of any certificated securities, the original certificates and duly executed powers of attorney in respect thereof in form and substance satisfactory to the Agent; and

4.3.1.2.2 if required to ensure perfection by control over such securities under Applicable Law, including without limitation, the laws of the jurisdiction of creation of the issuer, in the case of uncertificated securities or indirectly held securities in a securities account, a control agreement from the securities intermediary, if any, holding such securities in form and substance reasonably satisfactory to the Agent,

all of which collectively provide the Agent and the Lenders a first ranking charge over all such Equity Securities, subject to Permitted Encumbrances; and

4.3.1.3 a joinder and acknowledgment agreement with respect to the Credit Agreement executed by Thane Direct UK Limited in favour of the Agent and the Lenders.

4.4 Nature of Amendment.

4.4.1 The Parties intend that this Agreement amends the Credit Agreement but does not constitute a novation of the Credit Agreement. It is acknowledged and agreed by the Parties that the terms of this Agreement are in addition to the terms and conditions of the Credit Agreement, which terms and conditions continue to apply and remain in full force and effect and unless specifically provided for herein, will not limit, restrict, modify, amend or release, any of the agreements, covenants or understandings set out in the Credit Agreement. From and after the date of this Agreement, the Credit Agreement will be read and construed in conjunction with this Agreement, and the Credit Agreement, together with all of the powers, provisions, conditions, covenants, and agreements contained or implied in the Credit Agreement, will be, and will continue to be, in full force and effect, as amended by this Agreement. References to the "Credit Agreement" or the "Agreement" in the Credit Agreement or in any other document delivered in connection with, or pursuant to, the Credit Agreement, will mean the Credit Agreement, as amended by this Agreement.

ARTICLE 5

OBLIGATIONS OF THE CREDIT PARTIES DURING FORBEARANCE PERIOD

5.1 Covenants of the Borrowers and other Credit Parties

Each of the Borrowers and each of the other Credit Parties covenants and agrees as follows:

5.1.1 **Cash Flow:** During the Forbearance Period, the Borrowers and the other Credit Parties will take all steps necessary and cooperate fully with the Consultant to prepare

and complete the Forecast and the Cash Flow. The Borrowers and the other Credit Parties will provide the Consultant with full access to the management, systems, and books and records of the Borrowers and the other Credit Parties (subject to any access which is denied to comply with applicable privacy legislation and in order to legitimately preserve solicitor-client privilege), provided that the Consultant takes commercially reasonable measures not to disrupt the day to day operation of the business of the Credit Parties.

- 5.1.2 **Appraisal Rights:** The Agent and the Lenders shall have the right to appoint an appraiser to appraise the property, assets, and undertaking of the Borrowers and each other Credit Party at the expense of the Borrowers.

5.2 Joint Covenants of the Credit Parties

During the Forbearance Period and notwithstanding any other provisions of the Credit Agreement, each Credit Party covenants and agrees as follows:

- 5.2.1 that it will not, after the date hereof, without the prior written consent of the Agent, acting on behalf of the Lenders in accordance with the Credit Agreement, directly or indirectly, make any further loans or advance money or property to any Person (including, without limitation, the Subsidiaries and/or Affiliates of any Credit Party) other than Credit Party, or make any further investment in (by capital contribution, dividend or otherwise) or purchase or repurchase of the shares or indebtedness or all or a substantial part of the assets or property of any Person (including, without limitation, Subsidiaries and/or Affiliates of a Credit Party) other than a Credit Party, or make any further guarantee, assumption, endorsement, or otherwise become responsible for (directly or indirectly) the indebtedness, performance, obligations of or dividends paid to any Person after the date hereof (including, without limitation, the Subsidiaries and/or Affiliates of a Credit Party) or agree to do any of the foregoing and provided that the Borrowers shall promptly advise the Agent in writing of any of the foregoing transactions where the aggregate amount is equal to or greater than Cdn.\$1,000,000;
- 5.2.2 that it will not, without the prior written consent of the Agent, acting on behalf of the Lenders in accordance with the Credit Agreement, directly or indirectly, declare or pay any Distributions other than Distributions to a Credit Party;
- 5.2.3 that it will not, either directly or indirectly:
- 5.2.3.1 purchase, acquire or lease any property from, or sell, transfer or lease any property to, any officer, director, agent or other person affiliated with any Credit Party, except in the ordinary course of, and under the reasonable requirements of such Credit Party's business, and upon fair and reasonable terms no less favourable to the Credit Party than they would obtain in a comparable arm's length transaction with an unaffiliated person; or

- 5.2.3.2 make any payments of bonuses, management, consulting or other fees for management or similar services (including, without limitation, H.I.G. Manager Management Fees), or other remuneration or of any indebtedness owing to any officer, employee, shareholder, director or other person affiliated with a Credit Party, except reasonable compensation to officers, employees, directors and arm's-length consultants for services rendered to a Credit Party in the ordinary course of business (including for greater certainty performance-based bonuses under existing employment agreements provided that such payments are within the historic parameters for any such bonuses);
- 5.2.4 that neither the Borrowers nor any other Credit Party will enter into any transactions with any of their Subsidiaries, Affiliates, or other related Persons other than in the ordinary course of business and in compliance with the existing cash management arrangements among the Borrowers, the other Credit Parties, the Agent and the Lenders;
- 5.2.5 that it will cause every Unrestricted Subsidiary under the Credit Agreement and/or the Loan Documents to observe, perform and comply with the terms and conditions of this Agreement as if each of them executed this Agreement as a Credit Party;
- 5.2.6 that neither the Borrowers nor any other Credit Party will open any new accounts with any financial institutions other than the Agent or any Lender, and all accounts with financial institutions other than the Agent and the Lenders that exist as of the date hereof are listed on Schedule 3 to this Agreement;
- 5.2.7 save and except for arrears on contracts for storage and bailment as disclosed to the Agent in writing prior to the date hereof, that the Borrowers and the other Credit Parties shall maintain as current all payments due or payable under any lease or any mortgage of any premises out of which they operate, or contract for storage or bailment, and will otherwise not permit any default or event of default under any such lease, mortgage or contract, or forthwith obtain a waiver in writing from the relevant landlord, storer or bailee;
- 5.2.8 that the Credit Parties will provide any further or additional documents including, without limitation, the UK Security and all financing statements and financing change statements (and any equivalent personal property registrations in applicable foreign jurisdictions), whether provided for in the Credit Agreement, the other Loan Documents or otherwise, that the Agent may require to ensure that it has a first ranking mortgage charge and security interest against all of the property and assets of each of the Borrowers and the other Credit Parties, subject to Permitted Encumbrances;
- 5.2.9 subject to the Existing Defaults, that the Borrowers and the other Credit Parties will strictly adhere to all the terms, conditions and covenants of the Loan Documents, including terms requiring prompt payment of principal and interest amounts when

due, except to the extent that those terms, conditions and covenants are otherwise specifically amended by this Agreement;

- 5.2.10 that the Borrowers will provide to the Agent and the Consultant the following information:
- 5.2.10.1 as soon as possible after receipt, a copy of any notice received by the Borrowers or any other Credit Party in which any creditor, landlord or other third party delivers a notice of defect, default, demand, acceleration or enforcement in respect of any obligation of the Borrowers or any other Credit Party;
 - 5.2.10.2 the Borrowing Base certificate required under the Credit Agreement for the month ending October 31, 2013 which shall be provided to the Agent on or before November 15, 2013;
 - 5.2.10.3 all other reports and information required to be provided under the Credit Agreement, or as may be otherwise reasonably required by the Agent from time to time; and
 - 5.2.10.4 copies of all agreements of purchase and sale relating to any of the assets, property or undertaking, if any, of the Borrowers and/or any other Credit Party promptly upon their execution and/or receipt.

5.3 Additional Covenants

All of the covenants in this Agreement are in addition to and not in substitution for the covenants of the Credit Parties in the Loan Documents.

ARTICLE 6 EXISTING SECURITY

6.1 Existing Security

Each of the Borrowers and each other Credit Party acknowledge and agree that the Existing Security shall:

- 6.1.1 stand as continuing collateral security for all of the Borrowers' and each other Credit Party's liabilities, obligations and indebtedness to the Agent and the Lenders, as contemplated by the Existing Security, including without limitation, any Advances under the Credit Agreement; and
- 6.1.2 to the extent it constitutes a guarantee or security, not be released or discharged by the Agent whether in whole or in part, except in accordance with Section 15.7 of the Credit Agreement.

**ARTICLE 7
OBLIGATIONS OF THE AGENT DURING THE FORBEARANCE PERIOD**

7.1 Additional Loans

7.1.1 So long as the Credit Parties have complied with all of their obligations under the Credit Agreement, the other Loan Documents and this Agreement and no Terminating Event (save and except for the Existing Defaults) has occurred, then, despite the Existing Defaults, the Lenders will make further Loans up to the maximum of the Credit Limit (as reduced under this Agreement) provided that those Loans will not be used, directly or indirectly, for the repayment of any obligations, liabilities or indebtedness owing by the Borrowers or any other Credit Party to any Person not at arm's length with the Borrowers and any other Credit Party.

**ARTICLE 8
REPRESENTATIONS, WARRANTIES AND COVENANTS**

As at the date of this Agreement, each of the Credit Parties represents, warrants and covenants with and to the Agent and Lenders as follows:

8.1 Representations in Loan Documents

Each of the representations and warranties made by or on behalf of the Credit Parties to the Agent and/or any Lender in any of the Loan Documents was true and correct when made and in all material respects is, except for any representation and warranty set out in any of the Loan Documents relating to the non-existence of any Default or an Event of Default or which relate to an earlier date, true and correct on the date of this Agreement, with the same full force and effect as if each of those representations and warranties had been made by the applicable Credit Party on the date of, and within, this Agreement.

8.2 Full Effect of Documents

The Credit Agreement and the other Loan Documents are in full force and effect, except as modified by this Agreement.

8.3 No Conflict

The execution and delivery and performance of this Agreement by each Credit Party will not violate any requirement of Applicable Law or any contractual obligation of each Credit Party, and will not result in, or require, the creation or imposition of any Lien on any of its properties or revenues.

8.4 No Material Adverse Effect

Other than has been disclosed by the Borrowers to the Agent, as at the date hereof, the Borrowers have no knowledge of (and have made no specific investigation in respect of) any

action by the Borrowers or any other Credit Party, failure to take action by the Borrowers or any other Credit Party, breach of agreement, actions, suits, claims, proceedings or any other circumstances whatsoever, which have had or would be expected to have a Material Adverse Effect.

8.5 Terminating Events

Other than as may be consented to in writing by the Agent and Lenders, the occurrence of any of the following events will constitute a **“Terminating Event”** under this Agreement and an Event of Default under the Credit Agreement and the other Loan Documents:

- 8.5.1 any Additional Event of Default;
- 8.5.2 if the Borrowers or any other Credit Party fails to comply with the terms and conditions of this Agreement;
- 8.5.3 if any Credit Party defaults in any payment on its due date of any amount payable by it under any Loan Document, whether to the Agent or any Lender or otherwise, other than as provided for under this Agreement;
- 8.5.4 if any representation, warranty or other statement made or deemed to be made in this Agreement or in any of the documents to be delivered to the Agent or any Lender under or in connection with this Agreement by any Credit Party is untrue in any material respect when made or deemed to be made;
- 8.5.5 if the Borrowers, any other Credit Party or any Unrestricted Subsidiary contest or deny in any manner the legality, validity, binding nature or enforceability of this Agreement or the other Loan Documents or any liabilities and obligations to the Agent and/or Lenders under or relating to this Agreement or the other Loan Documents;
- 8.5.6 if the Borrowers’ or any other Credit Party’s assets and property, or any other property in the possession or control of the Borrowers or the other Credit Parties, is removed from the premises out of which any one of them operates, or where they are customarily stored, out of the ordinary course of business other than as specifically contemplated in this Agreement or with the prior written consent of the Agent;
- 8.5.7 if the Borrowers or the other Credit Parties fail to deposit on a daily basis promptly and in no way deviating from the ordinary course of business all of its receipts from all sources into their respective accounts maintained with the Agent;
- 8.5.8 if no agreement can be reached between the Agent, the Lenders and the Borrowers on the substance of the Cash Flow by December 2, 2013;
- 8.5.9 if the Credit Facility Limit (as reduced by this Agreement) is exceeded in any manner and the entire excess amount is not repaid to the Agent or the applicable Lenders within one (1) Business Day of Demand therefore;

- 8.5.10 if the board of directors of the Borrowers or any other Credit Party or management of the Borrowers or any other Credit Party fails to cooperate with the Consultant as contemplated by this Agreement and the Consulting Engagement;
- 8.5.11 if the Consultant is hampered or obstructed by the Borrowers or any other Credit Party (including their respective Boards of Directors, officers, management, employees, legal counsel, advisors or agents); or
- 8.5.12 if the Agent determines that a Material Adverse Effect has occurred; provided, for greater certainty, that the Existing Defaults (as and in the amounts set out in Schedule 1 hereto) shall not be relied upon by the Agent or the Lenders as constituting Material Adverse Effects for the purpose of this Section 8.5.12; but provided further, for greater certainty, that should the amount or nature of the Existing Defaults vary materially from that set out in Schedule 1 hereto, the Agent and the Lenders may rely thereon in declaring a Material Adverse Effect for the purpose of this Section 8.5.12.

Upon the occurrence of a Terminating Event, the Agent may declare the Forbearance Period to be terminated.

**ARTICLE 9
CONDITIONS TO EFFECTIVENESS OF CERTAIN PROVISIONS
OF THIS AGREEMENT**

9.1 Conditions to Effectiveness of Certain Provisions

The effectiveness of the terms and provisions of Section 3.1 and Section 7.1 of this Agreement will be subject to the receipt by the Agent of each of the following, in form and substance satisfactory to the Agent:

- 9.1.1 an original copy of this Agreement, duly authorized, executed and delivered by the Borrowers and the other Credit Parties;
- 9.1.2 the payment of the fee payable under Section 3.3.1 and the first month's monitoring fee payable under Section 3.3.2;
- 9.1.3 receipt by the Agent of an executed copy of an engagement letter between the Borrowers and the Consultant in form and substance satisfactory to the Agent in its sole discretion; and
- 9.1.4 the execution of all other documentation reasonably required by the Agent and its solicitors in connection with this Agreement including, without limitation, such further assurances, resolutions, opinions and additional confirmations or other agreements relating to the Security, all in form and substance satisfactory to the Agent.

ARTICLE 10 GENERAL

10.1 Effect of this Agreement

Except as modified by this Agreement, no other changes or modifications to the Loan Documents are intended or implied, and in all other respects the Loan Documents are specifically ratified, restated and confirmed by all Parties as of the effective date of this Agreement. To the extent of conflict between the terms of this Agreement, the Credit Agreement and the other Loan Documents, the terms of this Agreement will govern.

10.2 Costs and Expenses

The Borrowers hereby absolutely and unconditionally agrees to pay to and fully indemnify the Agent and the Lenders, on demand by the Agent at any time and as often as may be required, whether or not all or any of the transactions contemplated by this Agreement are consummated, all fees and disbursements of any counsel to the Agent and the Lenders, any other consultant (financial, appraiser or otherwise) or agent and all other expenses incurred by the Agent and the Lenders in connection with this Agreement, the Credit Facilities, the Loan Documents or the Security including (a) legal expenses in connection with the preparation, negotiation and interpretation of this Agreement, and the other agreements or documents contemplated by this Agreement, the other Loan Documents and the Security and the administration of the Credit Facilities generally; (b) all expenses of advisors and consultants to the Agent and Lenders (including legal expenses on a full indemnity basis) incurred in connection with the protection and enforcement of this Agreement and prior agreements, the other Loan Documents and the Security, or in connection with any proceeding in respect of bankruptcy, insolvency, winding up, receivership, dissolution, reorganization, liquidation, moratorium, arrangement or assignment for the benefit of creditors involving any Credit Party, in each of the foregoing events whether under the *Bankruptcy and Insolvency Act* (Canada), the *Companies' Creditors Arrangement Act* (Canada), or United States Bankruptcy Code (11 U.S.C. §101 et seq.), or any similar federal, state, provincial or foreign bankruptcy, insolvency, reorganization, receivership or similar law. The Borrowers specifically authorizes the Agent to debit from any of the Borrowers' accounts with the Agent the amount of any such existing and future fees and disbursements, and other expenses.

10.3 Survival of Representations and Warranties

All representations and warranties made in this Agreement or any other document delivered in connection with this Agreement will survive the execution and delivery of this Agreement and the other documents in accordance with the provisions of the *Limitations Act*, 2002 (Ontario) and no investigation by the Agent or any Lender or any closing will affect the representations and warranties or the right of the Agent and Lenders to rely upon them.

10.4 Reviewed by Legal Counsel

Each Credit Party represents and warrants to the Agent and the Lenders that it:

- 10.4.1 understands fully the terms of this Agreement and the consequences of the execution and delivery of this Agreement;
- 10.4.2 has been afforded an opportunity to have this Agreement reviewed by, and to discuss this Agreement and any documents executed in connection herewith with, such lawyers and other persons as such Credit Party may wish; and
- 10.4.3 has entered into this Agreement and executed and delivered all documents in connection herewith of its own free will and accord and without threat, duress or other coercion of any kind by any Person. The parties hereto acknowledge and agree that neither this Agreement nor the other documents executed pursuant hereto will be construed more favourably in favour of one than the other based upon which party drafted the same, it being acknowledged that all parties hereto contributed substantially to the negotiation and preparation of this Agreement and the other documents executed pursuant hereto or in connection herewith.

10.5 Governing Law

This Agreement is governed by, and is to be construed and interpreted in accordance with, the laws of the Province of Ontario and the laws of Canada applicable in that Province.

10.6 Submission to Jurisdiction

Each of the Parties irrevocably submits and attorns to the non-exclusive jurisdiction of the courts of the Province of Ontario to determine all issues, whether at law or in equity arising from this Agreement. To the extent permitted by Applicable Law, each of the Parties irrevocably waives any objection (including any claim of inconvenient forum) to the venue of any legal proceeding arising out of or relating to this Agreement in the courts of that Province, or that the subject matter of this Agreement may not be enforced in those courts, and irrevocably agrees not to seek, and hereby waives any right to, judicial review by any court which may be called upon to enforce the judgment of the courts referred to in this Section 10.6, of the substantive merits of any such suit, action or proceeding. To the extent a Party has or hereafter may acquire any immunity from the jurisdiction of any court or from any legal process (whether through service or notice, attachment prior to judgment, attachment in aid of execution, execution or otherwise) with respect to itself or its property, that Party irrevocably waives that immunity in respect of its obligations under this Agreement.

10.7 Mutual Waiver of Jury Trial

Because disputes arising in connection with complex financial transactions are most quickly and economically resolved by an experienced and expert person and the Parties wish applicable state/provincial and federal laws to apply (rather than arbitration rules), the Parties desire that their disputes be resolved by a judge applying those Applicable Laws. Therefore, to achieve the best combination of the benefits of the judicial system and of arbitration, the Parties waive all rights to trial by jury in any action, suit, or proceeding brought to resolve any dispute, whether arising in contract, tort, or otherwise between the Agent, the Lenders, the Borrowers and any

other Credit Party, arising out of, connected with, or related or incidental to, the relationship established between them in connection with this Agreement or any of the Loan Documents or the transactions related to this Agreement or any of the Loan Documents.

10.8 Time of Essence

Time is of the essence in all respects of this Agreement.

10.9 Notices

Any Communication must be in writing and must be delivered in accordance with Section 13.15 of the Credit Agreement.

10.10 Further Assurances

Each Credit Party will, at its own cost, execute and deliver all further agreements and documents and provide all further assurances as may be reasonably required by the Agent to give effect to this Agreement and, without limiting the generality of the foregoing, will do or cause to be done all acts and things, execute and deliver or cause to be executed and delivered all agreements and documents and provide such assurances, undertakings and information as may be required from time to time by all regulatory or governmental bodies.

10.11 Amendment and Waiver

No supplement, modification, amendment, waiver, discharge or termination of this Agreement is binding unless it is executed in writing by the Party to be bound. No waiver of, failure to exercise or delay in exercising, any provision of this Agreement constitutes a waiver of any other provision (whether or not similar) nor does such waiver constitute a continuing waiver unless otherwise expressly provided.

10.12 Assignment and Enurement

Neither the Borrowers nor any other Credit Party will be entitled to assign this Agreement or any right or obligation under this Agreement without the prior consent of the Agent. The Agent may assign this Agreement and any of its rights and obligations under this Agreement in accordance with Section 18 of the Credit Agreement. This Agreement enures to the benefit of and is binding upon the Parties and their respective successors and permitted assigns.

10.13 Severability

Each provision of this Agreement is distinct and severable. If any provision of this Agreement, in whole or in part, is or becomes illegal, invalid or unenforceable in any jurisdiction by a court of competent jurisdiction, the illegality, invalidity or unenforceability of that provision will not affect:

- 10.13.1 the legality, validity or enforceability of the remaining provisions of this Agreement;
or
- 10.13.2 the legality, validity or enforceability of that provision in any other jurisdiction.

10.14 Counterparts

This Agreement may be executed and delivered by the Parties in one or more counterparts, each of which when so executed and delivered will be an original and such counterparts will together constitute one and the same instrument.

10.15 Facsimile Signatures

Delivery of this Agreement by facsimile or "pdf" transmission constitutes valid and effective delivery.

THE REMAINDER OF THIS PAGE HAS BEEN INTENTIONALLY LEFT BLANK.

Each of the parties has executed and delivered this Agreement as of the date first written above.

THE BORROWERS:

THANE DIRECT, INC.

THANE DIRECT COMPANY

Per *[Signature]*
Name: *Russel Orloff*
Title: *Authorized Signatory*

Per *[Signature]*
Name: *Russel Orloff*
Title: *Authorized Signatory*

I have the authority to bind the Corporation.

I have the authority to bind the Corporation.

THE OTHER CREDIT PARTIES:

THANE INTERNATIONAL, INC.

DIRECT MARKETING HOLDINGS, INC.

Per: *[Signature]*
Name: *Russel Orloff*
Title: *Authorized Signatory*

Per: *[Signature]*
Name: *Russel Orloff*
Title: *Authorized Signatory*

I have the authority to bind the Corporation.

I have the authority to bind the Corporation.

**THANE DUTCH HOLDINGS
COOPERATIEF U.A.**

**WEST COAST DIRECT MARKETING,
INC.**

Per: _____
Name:
Title:

Per: _____
Name:
Title:

I have the authority to bind the Corporation.

I have the authority to bind the Corporation.

Each of the parties has executed and delivered this Agreement as of the date first written above.

THE BORROWERS:

THANE DIRECT, INC.

THANE DIRECT COMPANY

Per _____
Name:
Title:

Per _____
Name:
Title:

I have the authority to bind the Corporation.

I have the authority to bind the Corporation.

THE OTHER CREDIT PARTIES:

THANE INTERNATIONAL, INC.

DIRECT MARKETING HOLDINGS, INC.

Per _____
Name:
Title:

Per _____
Name:
Title:

I have the authority to bind the Corporation.

I have the authority to bind the Corporation.

**THANE DUTCH HOLDINGS
COOPERATIEF U.A.**

**WEST COAST DIRECT MARKETING,
INC.**

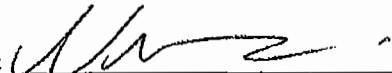
Per: 
Name: *MIRANDA*
Title:

Per: _____
Name:
Title:

I have the authority to bind the Corporation.

I have the authority to bind the Corporation.

Each of the parties has executed and delivered this Agreement as of the date first written above.

THE BORROWERS:

THANE DIRECT, INC.

THANE DIRECT COMPANY

Per _____
Name:
Title:

Per _____
Name:
Title:

I have the authority to bind the Corporation.

I have the authority to bind the Corporation.

THE OTHER CREDIT PARTIES:

THANE INTERNATIONAL, INC.

DIRECT MARKETING HOLDINGS, INC.

Per: _____
Name:
Title:

Per: _____
Name:
Title:

I have the authority to bind the Corporation.

I have the authority to bind the Corporation.

**THANE DUTCH HOLDINGS
COOPERATIEF U.A.**

**WEST COAST DIRECT MARKETING,
INC.**

Per: _____
Name:
Title:

Per: Bob Sencer
Name: BOB SENCER
Title: SECRETARY

I have the authority to bind the Corporation.

I have the authority to bind the Corporation.

- Signature 2 -

TDG INC.

THANE DIRECT CANADA INC.

Per: Bob Sencer
Name: Bob Sencer
Title: SECRETARY

Per: _____
Name:
Title:

I have the authority to bind the Corporation.

I have the authority to bind the Corporation.

- Signature 2 -

TDG INC.

THANE DIRECT CANADA INC.

Per: _____
Name:
Title:

Per: _____
Name: *Russell C. [unclear]*
Title: *Authorized Signatory*

I have the authority to bind the Corporation.

I have the authority to bind the Corporation.

- Signature 3 -

THE LENDERS:

BANK OF MONTREAL

NATIONAL BANK OF CANADA

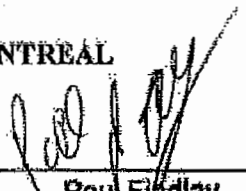
Per: 
Name: **Paul Findlay**
Title: **Senior Manager**

Per: _____
Name: _____
Title: _____

Per: _____
Name: _____
Title: _____

Per: _____
Name: _____
Title: _____

I/We have the authority to bind the Bank.

I/We have the authority to bind the Bank.

HSBC BANK CANADA

Per: _____
Name: _____
Title: _____

Per: _____
Name: _____
Title: _____

I/We have the authority to bind the Bank.

- Signature 3 -

THE LENDERS:

BANK OF MONTREAL

Per: _____
Name:
Title:

Per: _____
Name:
Title:

I/We have the authority to bind the Bank.

NATIONAL BANK OF CANADA

Per: 
Name: **Jean Gosselin**
Title: Directeur principal

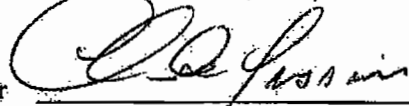
Per: 
Name: **CLAUDE LUSSIER**
Title: Dir. Principal

I/We have the authority to bind the Bank.

HSBC BANK CANADA

Per: _____
Name:
Title:

Per: _____
Name:
Title:

I/We have the authority to bind the Bank.

- Signature 3 -

THE LENDERS:

BANK OF MONTREAL

NATIONAL BANK OF CANADA

Per: _____
Name:
Title:

Per: _____
Name:
Title:

Per: _____
Name:
Title:

Per: _____
Name:
Title:

I/We have the authority to bind the Bank.

I/We have the authority to bind the Bank.

HSBC BANK CANADA

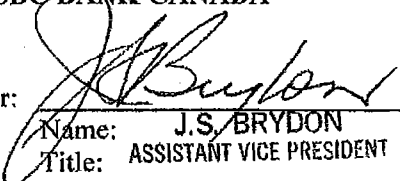
Per: 
Name: **J.S. BRYDON**
Title: **ASSISTANT VICE PRESIDENT**

Per: 
Name: **Cheryl Lee**
Title: **Senior Manager**

I/We have the authority to bind the Bank.

- Signature 4 -

THE AGENTS:

**BANK OF MONTREAL, as Co-Lead
Arranger, Syndication Agent and
Administrative Agent**

**HSBC BANK CANADA, as Co-Lead Arranger
and Documentation Agent**

Per: _____
Name: Jeannette MacDonald
Title: Director

Per: _____
Name:
Title:

Per: _____
Name:
Title:

Per: _____
Name:
Title:

I/We have the authority to bind the Bank.

I/We have the authority to bind the Bank.

- Signature 4 -

THE AGENTS:

BANK OF MONTREAL, as Co-Lead
Arranger, Syndication Agent and
Administrative Agent

HSBC BANK CANADA, as Co-Lead Arranger
and Documentation Agent

Per: _____
Name:
Title:

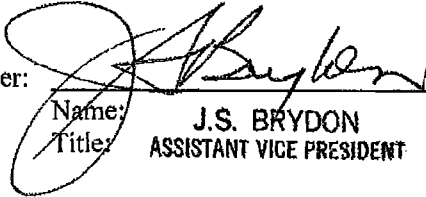
Per: 
Name: **J.S. BRYDON**
Title: **ASSISTANT VICE PRESIDENT**

Per: _____
Name:
Title:

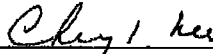
Per: 
Name: **Cheryl Lee**
Title: **Senior Manager**

I/We have the authority to bind the Bank.

I/We have the authority to bind the Bank.

SCHEDULE 1
EXISTING DEFAULTS SECTION 1.2

The following Defaults and Events of Default are existing and continuing:

1. Pursuant to Section 12.2 of the Credit Agreement, the Borrowers are obligated to repay a portion of the Outstanding Advances under Facility B by way of installment payments, payable quarterly in arrears on the last day of each Fiscal Quarter. An instalment payment in the amount USD \$3,750,000 was due on September 30, 2013. Pursuant to the Forbearance Letter between the Lenders and the Borrowers dated September 30, 2013, the due date for this payment was extended to October 31, 2013. As of the date of this Agreement, the Borrowers have failed to make the required instalment payment in the amount USD \$3,750,000 and, accordingly, an Event of Default has occurred under Section 15.1 of the Credit Agreement.
2. The Borrowers expect to not be in compliance with Sections 14.3.2 and 14.3.3 of the Credit Agreement for the period ending September 29, 2013.

SCHEDULE 2
EXISTING SECURITY

1. Guaranty by West Coast Direct Marketing, Inc. ("**West Coast**"), TDG, Inc. ("**TDG**"), Thane Direct, Inc. ("**Thane Direct US**"), Thane International, Inc. ("**Thane International**") and Direct Marketing Holdings, Inc. ("**Parent**") dated as of December 22, 2010 in favour of Bank of Montreal, as administrative agent (the "**Agent**").
2. Security Agreement between West Coast, TDG, Thane Direct US, Thane International and Parent and the Agent dated as of December 22, 2010.
3. Share Pledge Agreement between Thane Direct US, as pledgor, and the Agent re shares of Grupo Mejor Compra, S.A.P.I. de C.V. ("**Grupo**") dated December 22, 2010.
4. Agreement and Deed of Pledge of Cooperative Membership Rights between Thane Direct US and Thane International, as pledgors, and the Agent, re membership rights of Thane Dutch Holdings Coöperatief U.A. ("**Thane Netherlands**") dated December 22, 2010.
5. Agreement and Deed of Pledge of Cooperative Membership Rights (Subject to the Existing Pledges) between Thane Direct US and Thane International, as pledgors, and the Agent, re membership rights of Thane Netherlands dated September 28, 2012.
6. Guarantee by Thane Direct Company ("**TDC**") dated as of December 22, 2010 in favour of the Agent.
7. General Security Agreement between TDC and the Agent dated as of December 22, 2010.
8. Share Charge between TDC, as chargor, and the Agent dated December 22, 2010 relating to sixty-five percent of the issued share capital of Thane Direct UK Limited ("**Thane UK**").
9. Guarantee by Thane Netherlands dated as of December 22, 2010 in favour of the Agent.
10. Pledge Agreement between Thane Netherlands and the Agent dated as of December 22, 2010 re shares of TDC.
11. Guarantee by Thane Direct Canada Inc. ("**Thane Canada**") dated as of December 22, 2010 in favour of the Agent.
12. General Security Agreement between Thane Canada and the Agent dated as of December 22, 2010.

- Signature 2 -

13. Notice of Intention under Section 427 of the *Bank Act* from Thane Canada in favour of the Agent dated December 21, 2010.
14. Application for Credit and Promise to Give Bills of Lading, Warehouse Receipts, or Security under Section 427 of the *Bank Act* from Thane Canada in favour of the Agent dated December 22, 2010.
15. Special Security Agreement under Section 427 of the *Bank Act* from Thane Canada in favour of the Agent dated December 22, 2010.
16. Agreement as to Loans and Advances and Security therefor under Section 427 of the *Bank Act* from Thane Canada in favour of the Agent dated December 22, 2010.
17. Assigned Account Agreement between Bank of Montreal and Thane Direct US, accepted by BMO Harris Bank N.A. on September 28, 2012.
18. Assigned Account Agreement between Bank of Montreal and Thane Direct Company, accepted by BMO Harris Bank N.A. on September 28, 2012.
19. Assignment of Account Receivable Insurance from Atradius Trade Credit Insurance, Inc. together with direction to pay documents as applicable dated December 15, 2010.
20. Warehouse Bailment addressed to Northland Fulfillment from Thane Canada, the Agent and RBC, acknowledged by Northland Fulfillment dated December 23, 2010, together with Fulfillment Center Agreement addressed to the Agent and RBC from Thane International, acknowledged and agreed to by the Agent, RBC and Innotrac Corporation dated December 23, 2010.

**SCHEDULE 3
LIST OF ACCOUNTS**

Schedule of Non BMD and Harris Bank Accounts						
As of Oct 31, 2013						
Company	Description	Acct#	Institution	Country	Currency Denomination	
Thane Direct Company	Operating	80002 630 5911	Scotiabank (Canada)	Canada	USD	
Thane Direct Marketing, Inc.	Operating	47696-1087215	Scotiabank (Canada)	Canada	CAD	
Thane Direct Inc.	Operating	1459460082	Bank Of America	USA	USD	
Thane International Inc	Corporate Operating Account	1459102456	Bank of America	USA	USD	
Thane International Inc	Depository Account	1459104511	Bank of America	USA	USD	
Fox marketing Associates, Inc.		1496302517	Bank of America	USA	USD	
Thane International Inc	Returned Items	1459105162	Bank of America	USA	USD	
Thane International Inc	Thane Distribution Group	1496802741	Bank of America	USA	USD	
Thane International Inc	West Coast Account	1496502158	Bank of America	USA	USD	dormant
Thane International Inc	General Account	1458327027	Bank of America	USA	USD	dormant
Thane International Inc	Stock Escrow	1459922719	Bank of America	USA	USD	dormant
Thane International Inc	Transaction Escrow	1459441258	Bank of America	USA	USD	dormant
Thane Direct Inc	Pan European	1496902816	Bank of America	USA	USD	dormant

- Signature 2 -

TOR_LAW 828872118

TAB F

THIS IS **EXHIBIT "F"**
TO THE AFFIDAVIT OF **PAUL FINDLAY**
SWORN BEFORE ME THIS 16TH DAY
OF OCTOBER, 2015.



A Commissioner for Taking Affidavits

Clifton P. Prophet

AMENDED AND RESTATED FORBEARANCE AGREEMENT**BETWEEN:****THANE DIRECT COMPANY and THANE DIRECT, INC.****(as Borrowers)**

– and –

**BANK OF MONTREAL, NATIONAL BANK OF CANADA, HSBC BANK CANADA
AND SUCH OTHER LENDERS AS MAY BECOME PARTIES HERETO****(as Lenders)**

– and –

BANK OF MONTREAL**(as Co-Lead Arranger, Syndication Agent, and Administrative Agent)**

– and –

HSBC BANK CANADA**(as Co-Lead Arranger and Documentation Agent)**

– and –

CERTAIN AFFILIATES OF THE BORROWERS**(as the other Credit Parties)****MAY 26, 2014**

TABLE OF CONTENTS

	Page
ARTICLE 1	INTERPRETATION..... 2
1.1	Credit Agreement Definitions..... 2
1.2	Other Definitions 2
1.3	Entire Agreement..... 3
1.4	Business Day..... 3
1.5	Certain Rules of Interpretation..... 3
1.6	Schedules 4
ARTICLE 2	AMENDMENT AND RESTATEMENT AND ACKNOWLEDGMENTS 4
2.1	Amendment and Restatement 4
2.2	Acknowledgment of Obligations 5
2.3	Other Confirmations and Acknowledgments..... 5
2.4	Additional Acknowledgments of Guaranteeing Entities 8
2.5	Consent of Borrowers and other Credit Parties to Appointment of Receiver/Waiver of Redemption Rights 9
ARTICLE 3	FORBEARANCE IN RESPECT OF CERTAIN EVENTS OF DEFAULT 10
3.1	Forbearance..... 10
3.2	No Other Waivers; Reservation of Rights 11
3.3	Fees 11
3.4	Interest Rates..... 12
ARTICLE 4	AMENDMENTS TO CREDIT AGREEMENT 12
4.1	Amendment to Credit Agreement 12
4.2	Nature of Amendments 13
ARTICLE 5	OBLIGATIONS OF THE CREDIT PARTIES DURING FORBEARANCE PERIOD..... 13
5.1	Covenants of the Borrowers and other Credit Parties..... 13
5.2	Joint Covenants of the Credit Parties..... 15
5.3	Covenants regarding the SISP 17
5.4	Additional Covenants..... 17
ARTICLE 6	EXISTING SECURITY..... 17
6.1	Existing Security..... 17
ARTICLE 7	AMENDMENTS TO EXISTING SECURITY 18
7.1	Amendments to US Security Agreement..... 18
ARTICLE 8	OBLIGATIONS OF THE AGENT DURING THE FORBEARANCE PERIOD 19

TABLE OF CONTENTS
(continued)

		Page
8.1	Additional Loans.....	19
ARTICLE 9	REPRESENTATIONS, WARRANTIES AND TERMINATING EVENTS	19
9.1	Representations in Loan Documents	19
9.2	Full Effect of Documents.....	19
9.3	No Conflict.....	20
9.4	No Material Adverse Effect.....	20
9.5	Non-Lender Bank Accounts	20
9.6	Terminating Events.....	20
ARTICLE 10	CONDITIONS TO EFFECTIVENESS OF CERTAIN PROVISIONS OF THIS AGREEMENT	22
10.1	Conditions to Effectiveness of Certain Provisions	22
ARTICLE 11	GENERAL.....	23
11.1	Effect of this Agreement.....	23
11.2	No Consent to Sale.....	23
11.3	Release	23
11.4	Covenant Not to Sue	24
11.5	Costs and Expenses.....	24
11.6	Survival of Representations and Warranties.....	25
11.7	Reviewed by Legal Counsel	25
11.8	Governing Law	25
11.9	Submission to Jurisdiction	25
11.10	Mutual Waiver of Jury Trial	26
11.11	Time of Essence.....	26
11.12	Notices	26
11.13	Further Assurances.....	26
11.14	Amendment and Waiver	26
11.15	Assignment and Enurement	27
11.16	Severability	27
11.17	Counterparts.....	27
11.18	Facsimile Signatures	27

AMENDED AND RESTATED FORBEARANCE AGREEMENT

THIS AGREEMENT is dated as of May 26, 2014

B E T W E E N:

**THANE DIRECT COMPANY and THANE DIRECT, INC., as
Borrowers**

– and –

**BANK OF MONTREAL, NATIONAL BANK OF CANADA, HSBC
BANK CANADA AND SUCH OTHER LENDERS AS MAY
BECOME PARTIES HERETO, as lenders**

– and –

**BANK OF MONTREAL, as Co-Lead Arranger, Syndication Agent,
and Administrative Agent**

– and –

**HSBC BANK CANADA, as Co-Lead Arranger and Documentation
Agent**

– and –

**CERTAIN AFFILIATES OF THE BORROWERS, as the other
Credit Parties**

CONTEXT:

- A.** The Agent, the Lenders, and the Borrowers have entered into certain financing arrangements under an Amended and Restated Credit Agreement dated as of September 28, 2012 between, *inter alia*, the Agent, the Lenders, and the Borrowers (as may be amended, restated, revised, modified, renewed and/or replaced from time to time, the “**Credit Agreement**”).
- B.** As of the date of this Agreement, the Borrowers are in default under the Credit Agreement and the other Loan Documents which defaults constitute one or more Events of Default under the Loan Documents.

- C. The Borrowers requested that the Lenders forbear from exercising certain of their rights and remedies as a result of the Existing Defaults and to provide certain further Loans to the Borrowers. The Agent and the Lenders agreed to forbear from exercising certain of their rights and remedies and to provide further Loans to the Borrowers pursuant to the terms and conditions set out in a forbearance agreement dated November 12, 2013 between, *inter alia*, the Agent, the Lenders and the Borrowers, as amended by agreements dated December 13, 2013, January 24, 2014, February 14, 2014, February 28, 2014 and March 28, 2014, respectively (collectively, the “**Original Forbearance Agreement**”).
- D. The Parties hereto have agreed to amend and restate the Original Forbearance Agreement in accordance with the terms of this Agreement.

THEREFORE, the Parties agree as follows:

ARTICLE 1 INTERPRETATION

1.1 Credit Agreement Definitions

Each capitalized term used and not otherwise defined in this Agreement will have the meaning assigned to it in the Credit Agreement.

1.2 Other Definitions

In this Agreement the following terms have the following meanings:

- 1.2.1 “**Additional Events of Default**” means any Event of Default which is existing as of the date of this Agreement but is unknown to the Agent or which may occur on or after the date of this Agreement.
- 1.2.2 “**Agreement**” means this agreement, including all Schedules and Exhibits, as it may be supplemented or amended by written agreement between the Parties.
- 1.2.3 “**Cash Flow**” is defined in Section 2.3.6.3.
- 1.2.4 “**Communication**” means any notice, demand, request, consent, approval, or other communication which is required or permitted by this Agreement to be given or made by a Party.
- 1.2.5 “**CCAA**” means the *Companies’ Creditors Arrangements Act* (Canada).
- 1.2.6 “**Consultant**” is defined in Section 2.3.6.
- 1.2.7 “**Consulting Engagement**” is defined in Section 2.3.6.
- 1.2.8 “**Credit Agreement**” is defined under “Context”, above.

- 1.2.9 “**Existing Defaults**” means the Defaults and Events of Default that have occurred to the date of this Agreement as more particularly identified in Schedule 1.
- 1.2.10 “**Existing Security**” means the security described in Schedule 2 to this Agreement, as the same may be amended, restated, modified, supplemented, and/or replaced from time to time.
- 1.2.11 “**Forbearance Period**” is defined in Section 3.1.1.
- 1.2.12 “**Forecast**” is defined in Section 2.3.6.2.
- 1.2.13 “**Non-Lender Accounts**” is defined in Section 9.5.
- 1.2.14 “**Original Forbearance Agreement**” is defined under “Context” above;
- 1.2.15 “**SISP**” means the Sale and Investor Search Process Protocol in the form attached to this Agreement as Schedule 6, as may be amended from time to time in writing by the Parties and only in accordance with the terms thereof.
- 1.2.16 “**Terminating Event**” is defined in Section 9.6.
- 1.2.17 “**US Security Agreement**” is defined in Section 7.1.1.

1.3 Entire Agreement

This Agreement is a Loan Document and, together with the other Loan Documents and the agreements and other documents to be delivered pursuant to or in connection with this Agreement, constitute the entire agreement between the Parties pertaining to the subject matter of this Agreement and supersedes all prior agreements, understandings, negotiations and discussions, whether oral or written, of the Parties, and there are no representations, warranties or other agreements between the Parties in connection with the subject matter of this Agreement except as specifically set out in this Agreement, the other Loan Documents or the other agreements and documents delivered under this Agreement.

1.4 Business Day

Whenever any payment to be made or action to be taken under this Agreement is required to be made or taken on a day other than a Business Day, the payment is to be made or action taken on the next Business Day following.

1.5 Certain Rules of Interpretation

- 1.5.1 In this Agreement, words signifying the singular number include the plural and vice versa, and words signifying gender include all genders. Every use of the word “including” in this Agreement is to be construed as meaning “including, without limitation”.

- 1.5.2 The division of this Agreement into Articles and Sections, the insertion of headings and the provision of a table of contents are for convenience of reference only and do not affect the construction or interpretation of this Agreement.
- 1.5.3 References in this Agreement to an Article, Section, Schedule or Exhibit are to be construed as references to an Article, Section, Schedule or Exhibit of or to this Agreement unless the context requires otherwise.
- 1.5.4 Unless otherwise specified in this Agreement, time periods within which or following which any payment is to be made or act is to be done will be calculated by excluding the day on which the period commences and including the day on which the period ends. If the last day of a time period is not a Business Day, the time period will end on the next Business Day.
- 1.5.5 Unless otherwise specified, any reference in this Agreement to any statute includes all regulations made under that statute, and is to be construed as a reference to that statute as amended, supplemented or replaced from time to time.

1.6 Schedules

The following is a list of Schedules and Exhibits:

Schedule	Subject Matter	Section Reference
Schedule 1	Existing Defaults	1.2.9
Schedule 2	Existing Security	1.2.11
Schedule 3	Accounts	9.5
Schedule 4	Form of Irrevocable Proxy	10.1.3
Schedule 5	Form of Acknowledgment	10.1.4
Schedule 6	SISP	1.2.14
Schedule 7	Demand Letter and Section 244 Notices	2.3.4.1.

ARTICLE 2 AMENDMENT AND RESTATEMENT AND ACKNOWLEDGMENTS

2.1 Amendment and Restatement

Each of the Borrowers, the other Credit Parties and the Lenders agree that the terms and conditions of the Original Forbearance Agreement shall be amended and restated in accordance

Amended and Restated Forbearance Agreement

with the terms of this Agreement. Nothing in this Agreement shall constitute novation, payment, re-advance or otherwise of any existing indebtedness, liabilities and obligations of the Borrowers to the Agent and the Lenders.

2.2 Acknowledgment of Obligations

Each of the Borrowers and each other Credit Party acknowledges and agrees that as of April 30, 2014 the Outstanding Advances are as follows:

2.2.1 Facility A:

2.2.1.1 Aggregate Indebtedness in U.S. dollars in the amount of US\$5,340,000 plus applicable interest at US Base Rate of 5.75% plus 2% default interest rate.

2.2.2 Facility B:

2.2.2.1 Tranche 1 – Aggregate Indebtedness in U.S. dollars in the amount of US\$55,912,500 plus the applicable US Base Rate at 5.75% plus 2% default interest rate; and

2.2.2.2 Tranche 2 – Aggregate Indebtedness in U.S. dollars in the amount of US\$32,837,500 plus the applicable US Prime Rate at 5.25% plus 2% default interest rate.

2.2.3 Swingline Facility:

2.2.3.1 the aggregate amount outstanding under the Swingline Facility is US\$Nil plus applicable interest.

The foregoing amounts are not inclusive of any US\$ amounts on deposit with Bank of Montreal and/or BMO Harris Bank and do not account for cheques in the float as at April 30, 2014.

2.3 Other Confirmations and Acknowledgments

As of the date of this Agreement, each of the Borrowers and each other Credit Party confirms, acknowledges and agrees that:

2.3.1 the Existing Defaults have occurred and are continuing, each of which constitutes an Event of Default under the Loan Documents and the Borrowers further represent and warrant that as of the date of this Agreement no other Events of Default under the Loan Documents exist. The Agent has not waived the Existing Defaults and nothing contained in this Agreement or the transactions contemplated by this Agreement will be deemed to constitute any such waiver;

- 2.3.2 the Borrowers are unable to pay the Outstanding Obligations in full within a reasonable period of time;
- 2.3.3 interest and fees continue to accrue on the Outstanding Obligations under the Loan Documents at the rates applicable to the Outstanding Obligations as specified in the Loan Documents (including this Agreement);
- 2.3.4 as a result of the Existing Defaults, each of the Borrowers and the other Credit Parties:
- 2.3.4.1 acknowledges receipt of the demand letters from the Agent with respect to the repayment of the Outstanding Obligations under the Credit Agreement and the other Loan Documents (collectively, the “**Demand Letter**”), along with the corresponding notices of intention to enforce security pursuant to Section 244 of the BIA (collectively, the “**244 Notices**”), attached to this Agreement as Schedule 7;
- 2.3.4.2 agrees to waive the notice periods set forth in the Demand Letter and in the 244 Notices and consents to the immediate enforcement of the Security, including by way of the appointment of a court-appointed receiver, reorganization manager or similar agent in relation to its property, assets and undertaking, which consent is now granted but shall be effective automatically and immediately upon the termination of the Forbearance Period by the Agent;
- 2.3.5 each of the Borrowers and the other Credit Parties acknowledge and agree that, absent the existence of this Agreement, the Agent and the Lenders would have the right to immediately terminate the Credit Facilities and exercise their rights pursuant to the Loan Documents;
- 2.3.6 Ernst & Young LLP (the “**Consultant**”) has been engaged by the Agent’s legal counsel, Gowling Lafleur Henderson LLP (“**Gowlings**”), on behalf of the Lenders and at the sole expense of the Borrowers, as financial advisor to the Agent and the Lenders, in accordance with the terms and conditions of an engagement letter between the Consultant, Gowlings and the Agent dated November 8, 2013 (the “**Consulting Engagement**”). The scope, terms, and conditions of the Consulting Engagement include, but are not limited to, the following:
- 2.3.6.1 The Consultant shall conduct a full financial analysis of the Borrowers and the other Credit Parties in anticipation of developing a recapitalization plan and/or detailed restructuring plan;
- 2.3.6.2 The Consultant shall assist the Borrowers and the other Credit Parties in the preparation of a detailed and delineated 15-month cash flow forecast (the “**Forecast**”) covering the period from December 1, 2013 through to March 31, 2015, such Forecast to be delivered to the Agent and the Lenders by no later than November 25, 2013, and such

Forecast shall be satisfactory to the Agent and the Lenders in their sole and unfettered discretion;

- 2.3.6.3 The Consultant shall assist the Borrowers and the other Credit Parties in the preparation of a rolling 13-week cash flow forecast with respect to the business of the Borrowers collectively (the “Cash Flow”) which shall be delivered to the Agent and the Lenders by Wednesday of each week and such Cash Flow shall be satisfactory to the Agent and the Lenders in their unfettered discretion;
- 2.3.6.4 The Consultant shall recommend measures to conserve working capital;
- 2.3.6.5 The Consultant shall act as the financial advisor to the Agent and the Lenders;
- 2.3.6.6 The Consultant shall have the authority to: (A) respond to all questions from the Agent to the Consultant; and (B) disclose all information, data reviewed and considered by the Consultant and provide all reports, opinions, and views of the Consultant to the Agent (for and on behalf of itself and the Lenders) on a confidential basis. The Borrowers and the other Credit Parties shall not be entitled to any of the reports, opinion, and views of the Consultant to the Agent save and except that the Borrowers and the other Credit Parties may see draft reports (timing permitting) as contemplated in the Consulting Engagement, provided that any and all such draft reports shall be redacted to exclude all views, recommendations, conclusions and opinions of the Consultant;
- 2.3.6.7 The Consultant, acting reasonably, shall have the ability to disclose to the Agent (for and on behalf of itself and the Lenders) on a confidential basis any financial and operational information relating to the Borrowers and the other Credit Parties, including, without limitation, matters relating to the Forecast, the Cash Flow, the Borrowing Base, Priority Payables and related information, all in respect of the Borrowers and the other Credit Parties;
- 2.3.6.8 The Consultant shall review any factoring arrangements proposed by the Borrowers, within the context of its overall financial analysis of the Borrowers, and the Lenders will consider such factoring arrangements thereafter;
- 2.3.6.9 The Borrowers and each other Credit Party agree to grant all reasonable access and provide all reasonable information and documentation to, and to otherwise co-operate with and pay all fees and disbursements provided for in the Consulting Engagement of, the Consultant; and

- 2.3.6.10 The Borrowers and each other Credit Party consents to the Consulting Engagement on the terms and conditions set out therein.
- 2.3.7 it will not make any claims or bring any action against the Agent, the Lenders or their legal counsel in connection with or arising from the Consulting Engagement;
- 2.3.8 the Borrowers have paid, or will cause to be paid when due, all Priority Payables;
- 2.3.9 the Agent, for and on behalf of itself and the Lenders, has and will continue to have valid, enforceable, and perfected first-priority liens, mortgages, charges, and security interests upon and security interests in the Collateral (subject to Permitted Encumbrances) granted to the Agent, for and on behalf of itself and the Lenders, under the Security;
- 2.3.10 subject to any reservations or qualifications contained in any legal opinion previously delivered to the Agent, each of the Loan Documents to which the Agent, for and on behalf of itself and the Lenders, is party and this Agreement constitute legal, valid, and binding obligations of such Borrowers or the other Credit Parties, enforceable against it in accordance with their respective terms;
- 2.3.11 the Borrowers and/or the other Credit Parties do not have any valid claim for set-off, counter-claim, damages or other defence on any basis whatsoever against the Agent or any of the Lenders in respect of the Loan Documents and if there are any such claims, then it hereby expressly waives and forever releases the Agent and Lenders therefrom; and
- 2.3.12 subject to Applicable Law and the terms of this Agreement, the Agent and the Lenders are and will be entitled to the rights, remedies, and benefits provided for in the Loan Documents, this Agreement, and under Applicable Law.

2.4 Additional Acknowledgments of Guaranteeing Entities

As of the date of this Agreement, each Guaranteeing Entity acknowledges that:

- 2.4.1 its Guarantee has not been released, waived, or varied;
- 2.4.2 it consents to each of the Borrowers entering into this Agreement and acknowledges and confirms all representations and warranties, confirmations, obligations, and covenants of the Borrowers set out in this Agreement; and
- 2.4.3 to the extent that it is applicable or advisable, it has obtained independent legal advice.

2.5 Consent of Borrowers and other Credit Parties to Appointment of Receiver/Waiver of Redemption Rights

Each of the Borrowers and each other Credit Party acknowledges and agrees that upon the termination of the Forbearance Period by the Agent, the Agent and the Lenders shall be entitled to seek a court-appointed receiver over the Collateral (including all personal property, real property and fixtures) and over the business of the Borrowers and the Credit Parties. In connection therewith, each of the Credit Parties:

- 2.5.1 stipulates and consents (which consent is now granted but shall be effective automatically and immediately upon the termination of the Forbearance Period by the Agent) to Agent and the Lenders seeking the appointment by a court of competent jurisdiction of a receiver over such Credit Party, including in any legal proceeding, and for all or any portion of the real estate, personal property, and business of such Credit Party, with the power to sell all or any portion of the real estate, personal property, and/or business of such Credit Party pursuant to §291 of the Delaware General Corporation Law et. seq., the BIA, the CCAA, other available state or provincial laws or otherwise and agrees it will not contest the appointment of Ernst & Young LLP, or any of its affiliates or other party qualified to be a receiver, as receiver;
- 2.5.2 agrees that the foregoing consent in Section 2.5.1 shall be for a period of thirty (30) days from the date that the Agent has terminated the Forbearance Period, after which time if proceedings for the appointment of a receiver have not been commenced by the Agent within such thirty day period, the consent shall be automatically withdrawn. For greater certainty, if such proceedings have been commenced and not withdrawn, such consent shall not expire or be withdrawn and shall be effective unless and until a court of competent jurisdiction refuses to order the appointment of such receiver and all appeals of such decision have been exhausted or the time periods for any appeals thereof have expired;
- 2.5.3 if the Collateral is foreclosed upon, waives any and all rights of redemption that any Credit Party may have under federal or Delaware law concerning all or any portion of the real estate, personal property, and business of such Credit Party;
- 2.5.4 consents to any sale of all or any portion of the real estate, personal property, and business of the Credit Parties by the court-appointed receiver (if appointed during the time period specified in Section 2.5.2), as may be approved and consented to by the Lenders in their sole and absolute discretion; and
- 2.5.5 agrees to execute any documents that may be reasonably required in the future to evidence the consent and waiver by the Credit Parties set out in this Section 2.5 (to the extent such consent is then effect)

ARTICLE 3
FORBEARANCE IN RESPECT OF CERTAIN EVENTS OF DEFAULT

3.1 Forbearance

*Amended
per 2nd Amendment*

- 3.1.1 In reliance upon the acknowledgments, confirmations, representations, warranties, and covenants of the Credit Parties contained in this Agreement, and subject to the terms and conditions of this Agreement and any documents or instruments executed pursuant to or in connection with this Agreement, each of the Agent and the Lenders agrees to forbear from exercising its rights and remedies under the Loan Documents and/or Applicable Laws in respect of or arising out of the Existing Defaults for the period (the “**Forbearance Period**”) commencing on the date of this Agreement and ending on the earlier of:
- 3.1.1.1 the successful consummation of the transactions contemplated in the final agreement(s) with the Phase III Party pursuant to the SISP; and
 - 3.1.1.2 the occurrence or existence of any Terminating Event.
- 3.1.2 Upon the termination of the Forbearance Period due to a Terminating Event, the agreement of the Agent and the Lenders to forbear will automatically and without further action terminate and be of no force and effect, it being expressly agreed that the effect of that termination will be to permit the Agent, for and on behalf of the Lenders, to exercise all or any part of its rights and remedies immediately, including, without limitation, under the Loan Documents, subject to Applicable Law and the terms and conditions of the Loan Documents, including:
- 3.1.2.1 to immediately terminate each of the Credit Facilities;
 - 3.1.2.2 to cease to make any further Advances without any further notice, passage of time or forbearance of any kind;
 - 3.1.2.3 to accelerate all of the obligations under the Credit Facilities, the Credit Agreement and the other Loan Documents and to enforce all its rights under the Loan Documents;
 - 3.1.2.4 applying to the Court for the appointment of a receiver, receiver manager, interim receiver or liquidation or, privately appointing a receiver and manager or receiver under any and all applicable Federal, Provincial, State or other laws of Canada, the United States or any and all other jurisdictions where the Borrowers or any other Credit Party has assets or carries on business in any way; and
 - 3.1.2.5 apply for a creditor initiated application under the CCAA and/or the United States Bankruptcy Code.

3.2 No Other Waivers; Reservation of Rights

Neither the Agent nor any Lender has waived, nor by the entering into of this Agreement, is waiving, any Existing Defaults or Additional Events of Default (whether the same or similar to the Existing Defaults or otherwise). Neither the Agent nor any Lender has agreed to forbear with respect to any of its rights or remedies concerning any Existing Defaults or Additional Events of Default (other than, during the Forbearance Period, the Existing Defaults to the extent expressly set out in this Agreement), which may have occurred or are continuing as of the date of this Agreement or which may occur after the date of this Agreement. Neither the Agent nor any Lender has waived any of such rights or remedies, and nothing in this Agreement, and no delay on its part in exercising any such rights or remedies, should be construed as a waiver of those rights or remedies.

3.3 Fees

In consideration of the agreements set out in this Agreement, the Borrowers will pay to the Agent, for and on behalf of itself and the Lenders, the following fees:

- 3.3.1 a forbearance fee with respect to the Forbearance Period in the aggregate amount of \$300,000 which will be payable to each of the Lenders, according to each Lender's Proportionate Share, as follows:
- 3.3.1.1 \$50,000 is due and payable upon the execution of this Agreement; and
- 3.3.1.2 The balance of \$250,000 is due and payable upon the earlier to occur of (i) the termination by the Agent of the Forbearance Period, or (ii) the successful consummation of a transaction with the Phase III Party (as defined in the SISP). *1st Amendment \$450,000*
- 3.3.2 a monthly monitoring fee in the aggregate amount of \$20,000.00 per month which will be payable to each of the Lenders, according to each Lender's Proportionate Share, in respect of the Lenders' services for each month (or part thereof) while this Agreement remains in effect and for as long after that as any of the liabilities or obligations under the Credit Agreement or the other Loan Documents are outstanding; which fee will be fully earned as of and payable in advance on the date of this Agreement and on the first day of each month after that.

The foregoing fees are in addition to all other fees, interest, costs and expenses payable in connection with the Loan Documents, the Consultant, or otherwise, and may be charged by the Agent to any account of the Borrowers maintained by the Agent. The fees will be fully earned by the Agent despite any failure by any Credit Party to comply with any other term of this Agreement.

3.4 Interest Rates

- 3.4.1 During the Forbearance Period and thereafter at all times unless and until all Defaults and/or Events of Default have been cured to the satisfaction of the Agent and the Lenders, the Applicable Margin in respect of each of the Credit Facilities, which is adjusted from time to time in accordance with the provisions of the Credit Agreement, shall have added to it the additional two percent (2%) per annum default interest rate contemplated under Section 16.3 of the Credit Agreement.

ARTICLE 4 AMENDMENTS TO CREDIT AGREEMENT

4.1 Amendment to Credit Agreement.

- 4.1.1 The definition of “**Facility A Limit**” in Section 1.1.83 of the Credit Agreement is amended by deleting “10,000,000” from the first line of the definition and inserting the amount of “8,000,000” instead.
- 4.1.2 Section 14.1.5 of the Credit Agreement is amended by inserting “only” after “all Advances” in the first line.
- 4.1.3 The definition of “Permitted Indebtedness” in Section 1.1.83 of the Credit Agreement is amended by:
- 4.1.3.1 deleting “and” from the end of (l) of the definition;
 - 4.1.3.2 inserting “and” at the end of (m) of the definition; and
 - 4.1.3.3 inserting the following as (n) of the definition:
 - (n) Indebtedness owing by Danoz Direct Pty. Ltd (“**Danoz**”) to H.I.G. Direct Marketing Finance, Inc. and/or any of its Affiliates or any other shareholders or option holders of Direct Marketing Holdings, Inc. or their Affiliates (as used in this definition, collectively “**Assignees**”) pursuant to a factoring arrangement whereby Danoz sells and assigns, on an absolute and full recourse basis, certain of its accounts receivables to the Assignees (collectively, the “**Assigned Accounts**”) for a purchase price not to exceed the aggregate amount of U.S.\$2,500,000 (the “**HIG Factoring Arrangements**”) and provided that Danoz does not grant a Security Interest in any of its property, assets or undertaking to any Assignee in connection with the HIG Factoring Arrangement or otherwise, other than any necessary protective filings, notices and recordings in respect of the Assigned Accounts and the proceeds thereof,

including any cash or cash equivalents held in trust by Danoz for the Assignee in respect of such Assigned Accounts and insurance proceeds in respect of the assigned accounts and which for certainty shall not constitute collateral security for any other obligations under or in connection with the HIG Factoring Arrangements.

4.2 Nature of Amendments.

- 4.2.1 The Parties intend that this Agreement amends the Credit Agreement but does not constitute a novation of the Credit Agreement. It is acknowledged and agreed by the Parties that the terms of this Agreement are in addition to the terms and conditions of the Credit Agreement, which terms and conditions continue to apply and remain in full force and effect and unless specifically provided for herein, will not limit, restrict, modify, amend or release, any of the agreements, covenants or understandings set out in the Credit Agreement. From and after the date of this Agreement, the Credit Agreement will be read and construed in conjunction with this Agreement, and the Credit Agreement, together with all of the powers, provisions, conditions, covenants, and agreements contained or implied in the Credit Agreement, will be, and will continue to be, in full force and effect, as amended by this Agreement. References to the "Credit Agreement" or the "Agreement" in the Credit Agreement or in any other document delivered in connection with, or pursuant to, the Credit Agreement, will mean the Credit Agreement, as amended by this Agreement.

ARTICLE 5

OBLIGATIONS OF THE CREDIT PARTIES DURING FORBEARANCE PERIOD

5.1 Covenants of the Borrowers and other Credit Parties

Each of the Borrowers and each of the other Credit Parties covenants and agrees as follows:

- 5.1.1 **Cash Flow:** During the Forbearance Period, the Borrowers and the other Credit Parties will take all steps necessary and cooperate fully with the Consultant to prepare and complete the Forecast and the Cash Flow. The Borrowers and the other Credit Parties will provide the Consultant with full access to the management, systems, and books and records of the Borrowers and the other Credit Parties (subject to any access which is denied to comply with applicable privacy legislation and in order to legitimately preserve solicitor-client privilege), provided that the Consultant takes commercially reasonable measures not to disrupt the day to day operation of the business of the Credit Parties.
- 5.1.2 **Appraisal Rights:** The Agent and the Lenders shall have the right to appoint an appraiser to appraise the property, assets, and undertaking of the Borrowers and each other Credit Party at the expense of the Borrowers.

- 5.1.3 **Weekly Cash Flow:** During the Forbearance Period, the Borrowers and the other Credit Parties will take all steps necessary and cooperate fully with the Consultant to prepare a summary of weekly cash flow results, in arrears, and including a comparison of such weekly results to the Cash Flow (for the same period), in a form as approved by the Consultant, and the Borrowers shall deliver such cash flow summary to the Agent by the close of business on Wednesday of each week. Each cash flow summary shall cover the period for the immediately prior week.
- 5.1.4 **Cash from Subsidiaries:** During the Forbearance Period, the Borrowers will cause an aggregate amount of not less than \$2,000,000 to be transferred from certain of their Subsidiaries to the Borrowers to be used for general corporate purposes of the Borrowers.
- 5.1.5 **Variance from Cash Flow:** During the Forbearance Period, the Borrowers shall implement, operate their businesses in accordance with, and take any action that may be necessary to achieve, the Cash Flow, subject to the following:
- 5.1.5.1 commencing with the Cash Flow delivered no later than March 5, 2014 as the base case, actual total receipts compared to the total receipts as set out in the Cash Flow for the immediately prior week shall not have a negative variance of more than 10%;
- 5.1.5.2 commencing with the Cash Flow delivered no later than March 5, 2014 as the base case, actual total disbursements compared to the total disbursements as set out in the Cash Flow for the immediately prior week shall not have a positive variance of more than 10%; and
- 5.1.5.3 commencing with the Cash Flow delivered no later than April 2, 2014 as the base case, actual net Cash Flow compared to net Cash Flow as set out in the Cash Flow for the immediately prior week shall not have a negative variance of more than \$250,000.00,
- provided that the foregoing shall in no way derogate from, or relieve the Borrowers from complying with, the restrictions on the maximum amount of Outstanding Advances permitted to be outstanding at any time pursuant to the provisions of the Credit Agreement.
- Amended per
1st Amend 4
- 5.1.6 **Deterioration of EBITDA:** During the Forbearance Period, the Borrowers shall maintain a minimum rolling cumulative three month EBITDA threshold calculated within 30 days of each month end commencing with the month of April 2014 as set out below:

<u>Month</u>	<u>Rolling 3 Month EBITDA Minimum</u>
April 2014 (based on February 2014 to April 2014)	\$1.6 million
May 2014 (based on March 2014 to May 2014)	\$1.5 million
June 2014 (based on April 2014 to June 2014)	\$2.0 million
July 2014 (based on May 2014 to July 2014)	\$2.5 million
August 2014 (based on June 2014 to August 2014)	\$3.0 million
September 2014 (based on July 2014 to September 2014)	\$3.0 million
October 2014 (based on August 2014 to October 2014)	\$3.7 million
November 2014 (based on September 2014 to November 2014)	\$4.7 million
December 2014 (based on October 2014 to December 2014)	\$6.0 million

Amended per
1st Amendment

5.2 Joint Covenants of the Credit Parties

During the Forbearance Period and notwithstanding any other provisions of the Credit Agreement, each Credit Party covenants and agrees as follows:

- 5.2.1 that it will not, after the date hereof, without the prior written consent of the Agent, acting on behalf of the Lenders in accordance with the Credit Agreement, directly or indirectly, make any further loans or advance money or property to any Person (including, without limitation, the Subsidiaries and/or Affiliates of any Credit Party) other than Credit Party, or make any further investment in (by capital contribution, dividend or otherwise) or purchase or repurchase of the shares or indebtedness or all or a substantial part of the assets or property of any Person (including, without limitation, Subsidiaries and/or Affiliates of a Credit Party) other than a Credit Party, or make any further guarantee, assumption, endorsement, or otherwise become responsible for (directly or indirectly) the indebtedness, performance, obligations of or dividends paid to any Person after the date hereof (including, without limitation, the Subsidiaries and/or Affiliates of a Credit Party) or agree to do any of the foregoing and provided that the Borrowers shall promptly advise the Agent in writing of any of the foregoing transactions where the aggregate amount is equal to or greater than Cdn.\$1,000,000;
- 5.2.2 that it will not, without the prior written consent of the Agent, acting on behalf of the Lenders in accordance with the Credit Agreement, directly or indirectly, declare or pay any Distributions other than Distributions to a Credit Party;
- 5.2.3 that it will not, either directly or indirectly:
- 5.2.3.1 purchase, acquire or lease any property from, or sell, transfer or lease any property to, any officer, director, agent or other person affiliated with any Credit Party, except in the ordinary course of, and under the reasonable requirements of such Credit Party's business, and upon fair and reasonable terms no less favourable to the Credit Party than

they would obtain in a comparable arm's length transaction with an unaffiliated person; or

- 5.2.3.2 make any payments of bonuses, management, consulting or other fees for management or similar services (including, without limitation, H.I.G. Manager Management Fees), or other remuneration or of any indebtedness owing to any officer, employee, shareholder, director or other person affiliated with a Credit Party, except reasonable compensation to officers, employees, directors and arm's-length consultants for services rendered to a Credit Party in the ordinary course of business (including for greater certainty performance-based bonuses under existing employment agreements provided that such payments are within the historic parameters for any such bonuses);
- 5.2.4 except in respect of the HIG Factoring Arrangements that neither the Borrowers nor any other Credit Party will enter into any transactions with any of their Subsidiaries, Affiliates, or other related Persons other than in the ordinary course of business and in compliance with the existing cash management arrangements among the Borrowers, the other Credit Parties, the Agent and the Lenders;
- 5.2.5 that it will cause every Unrestricted Subsidiary under the Credit Agreement and/or the Loan Documents to observe, perform and comply with the terms and conditions of this Agreement as if each of them executed this Agreement as a Credit Party;
- 5.2.6 except in respect of the HIG Factoring Arrangements that neither the Borrowers nor any other Credit Party will open any new accounts with any financial institutions other than the Agent or any Lender;
- 5.2.7 with respect to any Non-Lender Accounts, neither the Borrowers nor any other Credit Party shall use any such Non-Lender Account for any purpose other than for the limited purpose set out in the "Purpose" column beside the description of such account in Schedule 3 to this Agreement;
- 5.2.8 save and except for arrears on contracts for storage and bailment as disclosed to the Agent in writing prior to the date hereof, that the Borrowers and the other Credit Parties shall maintain as current all payments due or payable under any lease or any mortgage of any premises out of which they operate, or contract for storage or bailment, and will otherwise not permit any default or event of default under any such lease, mortgage or contract, or forthwith obtain a waiver in writing from the relevant landlord, storer or bailee;
- 5.2.9 that the Credit Parties will provide any further or additional documents or agreements and all financing statements and financing change statements (and any equivalent personal property registrations in applicable foreign jurisdictions), whether provided for in the Credit Agreement, the other Loan

Documents or otherwise, that the Agent may require to ensure that it has a first ranking mortgage charge and security interest against all of the property and assets of each of the Borrowers and the other Credit Parties, subject to Permitted Encumbrances;

5.2.10 subject to the Existing Defaults, that the Borrowers and the other Credit Parties will strictly adhere to all the terms, conditions and covenants of the Loan Documents, including terms requiring prompt payment of principal and interest amounts when due, except to the extent that those terms, conditions and covenants are otherwise specifically amended by this Agreement; and

5.2.11 that the Borrowers will provide to the Agent and the Consultant the following information:

5.2.11.1 as soon as possible after receipt, a copy of any notice received by the Borrowers or any other Credit Party in which any creditor, landlord or other third party delivers a notice of defect, default, demand, acceleration or enforcement in respect of any obligation of the Borrowers or any other Credit Party;

5.2.11.2 all other reports and information required to be provided under the Credit Agreement, or as may be otherwise reasonably required by the Agent from time to time; and

5.2.11.3 copies of all agreements of purchase and sale relating to any of the assets, property or undertaking, if any, of the Borrowers and/or any other Credit Party promptly upon their execution and/or receipt.

5.3 Executing Term sheet.

5.3 5.4 Covenants regarding the SISP

Each of the Borrowers and each other Credit Party covenants and agrees that it will observe and perform each of the Milestones set out in the SISP within the time frames set out therein.

deleted

5.4 Additional Covenants

All of the covenants in this Agreement are in addition to and not in substitution for the covenants of the Credit Parties in the Loan Documents.

ARTICLE 6 EXISTING SECURITY

6.1 Existing Security

Each of the Borrowers and each other Credit Party acknowledge and agree that the Existing Security shall:

- 6.1.1 stand as continuing collateral security for all of the Borrowers' and each other Credit Party's liabilities, obligations and indebtedness to the Agent and the Lenders, as contemplated by the Existing Security, including without limitation, any Advances under the Credit Agreement; and
- 6.1.2 to the extent it constitutes a guarantee or security, not be released or discharged by the Agent whether in whole or in part, except in accordance with Section 15.7 of the Credit Agreement.

ARTICLE 7 AMENDMENTS TO EXISTING SECURITY

7.1 Amendments to US Security Agreement

- 7.1.1 The security agreement between West Coast Direct Marketing, Inc., Thane Direct Inc., TDG, Inc., Thane International, Inc., and Direct Marketing Holdings, Inc. in favour of the Agent dated as of December 22, 2010 (the "US Security Agreement") is amended as follows:
 - 7.1.1.1 The last sentence in Section 8(b) is amended by deleting in its entirety the proviso that begins with "provided, however, the Agent shall not exercise any remedies..." and ends with "prescribed by applicable law)";
 - 7.1.1.2 The first sentence in Section 10(b) is amended by deleting in its entirety the proviso that begins with "provided, however, the Agent shall not exercise any remedies..." and ends with "prescribed by applicable law)";
 - 7.1.1.3 The first sentence in Section 10(c) is amended by deleting the words in the first parentheses that begins with "(and, to the extent that any of the following..." and ends with "prescribed by applicable law))"; and
 - 7.1.1.4 The first sentence in Section 10(d) is amended by deleting the words in the first parentheses that begins with "such notice period to run concurrently..." and ends with "prescribed by applicable law))".

7.1.2 Nature of Amendments

The Parties intend that this Agreement amends the US Security Agreement but does not constitute a novation of the US Security Agreement. Each of the Parties acknowledge and agree that the terms of this Agreement are in addition to the terms and conditions of the US Security Agreement, which terms and conditions continue to apply and remain in full force and effect and unless specifically provided for herein, will not limit, restrict, modify, amend or release, any of the agreements, covenants or understandings set out in the US Security Agreement. From and after the date of this Agreement, the US Security Agreement will be read and construed in conjunction

with this Agreement, and the US Security Agreement, together with all of the powers, provisions, conditions, covenants, and agreements contained or implied in the US Security Agreement, will be, and will continue to be, in full force and effect, as amended by this Agreement. References to the "Security Agreement" or the "Agreement" in the US Security Agreement or in any other document delivered in connection with, or pursuant to, the US Security Agreement, will mean the US Security Agreement, as amended by this Agreement.

ARTICLE 8

OBLIGATIONS OF THE AGENT DURING THE FORBEARANCE PERIOD

8.1 Additional Loans

- 8.1.1 So long as the Credit Parties have complied with all of their obligations under the Credit Agreement, the other Loan Documents and this Agreement and no Terminating Event (save and except for the Existing Defaults) has occurred, then, despite the Existing Defaults, the Lenders will make further Loans up to the maximum of the Credit Limit (as reduced under this Agreement) provided that those Loans will not be used, directly or indirectly, for the repayment of any obligations, liabilities or indebtedness owing by the Borrowers or any other Credit Party to any Person not at arm's length with the Borrowers and any other Credit Party.

ARTICLE 9

REPRESENTATIONS, WARRANTIES AND TERMINATING EVENTS

As at the date of this Agreement, each of the Credit Parties represents, warrants and covenants with and to the Agent and Lenders as follows:

9.1 Representations in Loan Documents

Each of the representations and warranties made by or on behalf of the Credit Parties to the Agent and/or any Lender in any of the Loan Documents was true and correct when made and in all material respects is, except for any representation and warranty set out in any of the Loan Documents relating to the non-existence of any Default or an Event of Default or which relate to an earlier date, true and correct on the date of this Agreement, with the same full force and effect as if each of those representations and warranties had been made by the applicable Credit Party on the date of, and within, this Agreement.

9.2 Full Effect of Documents

The Credit Agreement and the other Loan Documents are in full force and effect, except as modified by this Agreement.

9.3 No Conflict

The execution and delivery and performance of this Agreement by each Credit Party will not violate any requirement of Applicable Law or any contractual obligation of each Credit Party, and will not result in, or require, the creation or imposition of any Lien on any of its properties or revenues.

9.4 No Material Adverse Effect

Other than has been disclosed by the Borrowers to the Agent, as at the date hereof, the Borrowers have no knowledge of (and have made no specific investigation in respect of) any action by the Borrowers or any other Credit Party, failure to take action by the Borrowers or any other Credit Party, breach of agreement, actions, suits, claims, proceedings or any other circumstances whatsoever, which have had or would be expected to have a Material Adverse Effect.

9.5 Non-Lender Bank Accounts

The accounts listed in Schedule 3 to this Agreement are all of the bank accounts existing as of the date hereof that are held at financial institutions other than the Agent and the Lenders (collectively, the “**Non-Lender Accounts**”) and the purpose and use of each such account is also set out in Schedule 3.

9.6 Terminating Events

Other than as may be consented to in writing by the Agent and Lenders and other than the Existing Defaults, the occurrence of any of the following events will constitute a “**Terminating Event**” under this Agreement and an Event of Default under the Credit Agreement and the other Loan Documents:

- 9.6.1 any Additional Event of Default;
- 9.6.2 if the Borrowers or any other Credit Party fails to comply with the terms and conditions of this Agreement;
- 9.6.3 if any Credit Party defaults in any payment on its due date of any amount payable by it under any Loan Document, whether to the Agent or any Lender or otherwise, other than as provided for under this Agreement;
- 9.6.4 if the Investment Advisor does not receive: (i) any preliminary proposals from interested buyers or investors on or before the Proposal Date (as defined in the SISP), or (ii) any written proposals by the Phase II Parties on or before the Diligence Date (as defined in the SISP);
- 9.6.5 if the Borrowers or any Credit Party fails to observe any of the Milestones set out in the SISP within five (5) Business Days of the applicable time frames set out therein, provided that the Borrowers and the Credit Parties may only utilize

an aggregate of ten (10) Business Days in total to extend any applicable timeframes set out in the SISP for a Milestone. For greater certainty, the total timeframe for the Milestones set out in the SISP may not be extended by more than ten (10) Business Days without the consent of the Agent, on behalf of the Lenders;

- 9.6.6 if the Agent elects not to approve the final engagement letter for the Investment Advisor, the selection of the Phase II Parties, the selection of the Phase III Party or the definitive agreements with the Phase III Party as set out in the SISP;
- 9.6.7 if any representation, warranty or other statement made or deemed to be made in this Agreement or in any of the documents to be delivered to the Agent or any Lender under or in connection with this Agreement by any Credit Party is untrue in any material respect when made or deemed to be made;
- 9.6.8 if the Borrowers, any other Credit Party or any Unrestricted Subsidiary contest or deny in any manner the legality, validity, binding nature or enforceability of this Agreement or the other Loan Documents or any liabilities and obligations to the Agent and/or Lenders under or relating to this Agreement or the other Loan Documents;
- 9.6.9 if the Borrowers' or any other Credit Party's assets and property, or any other property in the possession or control of the Borrowers or the other Credit Parties, is removed from the premises out of which any one of them operates, or where they are customarily stored, out of the ordinary course of business other than as specifically contemplated in this Agreement or with the prior written consent of the Agent;
- 9.6.10 if the Borrowers or the other Credit Parties fail to deposit on a daily basis promptly and in no way deviating from the ordinary course of business all of its receipts from all sources into their respective accounts maintained with the Agent;
- 9.6.11 if the Credit Facility Limit (as reduced by this Agreement) is exceeded in any manner and the entire excess amount is not repaid to the Agent or the applicable Lenders within one (1) Business Day of Demand therefore;
- 9.6.12 if the board of directors of either of the Borrowers or any other Credit Party or the management of either of the Borrowers or any other Credit Party fails to cooperate with the Consultant as contemplated by this Agreement and the Consulting Engagement;
- 9.6.13 if the Consultant is hampered or obstructed by the Borrowers or any other Credit Party (including their respective Boards of Directors, officers, management, employees, legal counsel, advisors or agents); or
- 9.6.14 if the Agent determines that a Material Adverse Effect has occurred; provided, for greater certainty, that the Existing Defaults (as and in the amounts set out in

Schedule 1 hereto) shall not be relied upon by the Agent or the Lenders as constituting Material Adverse Effects for the purpose of this Section 9.6.14; but provided further, for greater certainty, that should the amount or nature of the Existing Defaults vary materially from that set out in Schedule 1 hereto, the Agent and the Lenders may rely thereon in declaring a Material Adverse Effect for the purpose of this Section 9.6.14.

Upon the occurrence of a Terminating Event, the Agent may declare the Forbearance Period to be terminated.

ARTICLE 10
CONDITIONS TO EFFECTIVENESS OF CERTAIN PROVISIONS
OF THIS AGREEMENT

10.1 Conditions to Effectiveness of Certain Provisions

The effectiveness of the terms and provisions of Section 3.1 and Section 8.1 of this Agreement will be subject to the receipt by the Agent of each of the following, in form and substance satisfactory to the Agent:

- 10.1.1 an original copy of this Agreement, duly authorized, executed and delivered by the Borrowers and the other Credit Parties;
- 10.1.2 the payment of the fee payable under Section 3.3.1 and the first month's monitoring fee payable under Section 3.3.2;
- 10.1.3 an irrevocable proxy coupled with an interest executed and delivered by each company that has pledged an equity interest to the Agent (including, without limitation, Direct Marketing Holdings, Inc., Thane International, Inc., and Thane Direct, Inc.) substantially in the form attached to this Agreement as Schedule 4 or such other form as may be approved by the Agent;
- 10.1.4 an acknowledgment by each United States subsidiary that has its equity pledged to the Agent in accordance with the Security (including, without limitation, Thane International, Inc., West Coast Direct Marketing, Inc., Thane Cybermall, Inc., TDG, Inc., Fox Marketing Associates, Inc., Thane Direct, Inc.) substantially in the form attached to this Agreement as Schedule 5 or such other form as may be approved by the Agent;
- 10.1.5 approval by Borrowers and each other Credit Party of the SISP in the form attached to this Agreement as Schedule 6;
- 10.1.6 the execution of all other documentation reasonably required by the Agent and its solicitors in connection with this Agreement including, without limitation, such further assurances, resolutions, opinions and additional confirmations or other agreements relating to the Security, all in form and substance satisfactory to the Agent.

ARTICLE 11 GENERAL

11.1 Effect of this Agreement

Except as modified by this Agreement, no other changes or modifications to the Loan Documents are intended or implied, and in all other respects the Loan Documents are specifically ratified, restated and confirmed by all Parties as of the effective date of this Agreement. To the extent of conflict between the terms of this Agreement, the Credit Agreement and the other Loan Documents, the terms of this Agreement will govern.

11.2 No Consent to Sale

For greater certainty, nothing in this Agreement shall be deemed to be or construed to be a consent on the part of the Agent or the Lenders to any results of the SISP or to any sale, transfer, assignment or other disposition of the Equity Securities or assets, property or undertakings of the Borrowers or any other Credit Party and in no event shall the Agent or the Lenders be required to release or discharge any of their Security Interests in respect thereof until such time as the Agent, on behalf of the Lenders, has approved a final agreement with the Phase III Party (as set out in the SISP) and the transactions contemplated by such final agreement have been successfully concluded to the satisfaction of the Agent and the Lenders.

11.3 Release

- 11.3.1 In consideration of this Agreement and for other good and valuable consideration, each of the Borrowers and each other Credit Party, on their own behalf and on behalf of their respective successors, assigns, heirs, executors or administrators, absolutely, unconditionally and irrevocably releases, remises and forever discharges the Agent and each of the Lenders, and each of their present and former shareholders, affiliates, subsidiaries, divisions, predecessors, directors, officers, legal counsel, employees, agents and other representatives, and their respective successors and assigns (the Agent and the Lenders and such other Persons being hereinafter referred to collectively as the "**Releasees**" and individually as a "**Releasee**"), of and from all demands, actions, causes of action, suits, covenants, contracts, controversies, agreements, promises, sums of money, accounts, bills, reckonings, damages and any and all other claims, counterclaims, defences, rights of set-off, demands and liabilities (individually, a "**Claim**" and collectively, "**Claims**") known or unknown, both at law and in equity, which a Borrower or any Credit Party or any of their respective successors, assigns, heirs, executors or administrators may now or later have or claim against any of the Releasees by reason of any circumstance, action, cause or thing which may have arisen at any time on or prior to the date of this Agreement, on account of, or in relation to, or in any way in connection with, any of the Loan Documents or transactions under or related to the Loan Documents;

- 11.3.2 Each of the Borrowers and each other Credit Party understands, acknowledges and agrees that the release set out in Section 11.3.1 may be pleaded as a full and complete defence and may be used as a basis for an injunction against any action, suit or other proceeding which may be instituted, prosecuted or attempted in breach of the provisions of that release; and
- 11.3.3 each of the Borrowers and each other Credit Party agrees that no fact, event, circumstance, evidence or transaction which could now be asserted or which may later be discovered will affect in any manner the final, absolute and unconditional nature of the release set out in Section 11.3.1.

11.4 Covenant Not to Sue

Each of the Borrowers and each other Credit Party, on their own behalf and on behalf of their respective successors, assigns, and other legal representatives, absolutely, unconditionally and irrevocably, covenants and agrees with and in favour of each Releasee that it will not sue (at law, in equity, in any regulatory proceeding or otherwise) any Releasee on the basis of any Claim released by the Borrowers under Section 11.3.1 above. If a Borrower or any other Credit Party or any of their respective successors, assigns or other legal representatives violates the foregoing covenant, the Borrowers and the other Credit Parties, for themselves and their successors, assigns and legal representatives, agree to pay (and fully indemnify the Agent and the Lenders for) in addition to any other damages that any Releasee may sustain as a result of that violation, all legal fees and costs incurred by any Releasee as a result of that violation.

11.5 Costs and Expenses

The Borrowers hereby absolutely and unconditionally agrees to pay to and fully indemnify the Agent and the Lenders, on demand by the Agent at any time and as often as may be required, whether or not all or any of the transactions contemplated by this Agreement are consummated, all fees and disbursements of any counsel to the Agent and the Lenders, any other consultant (financial, appraiser or otherwise) or agent and all other expenses incurred by the Agent and the Lenders in connection with this Agreement, the Credit Facilities, the Loan Documents or the Security including (a) legal expenses in connection with the preparation, negotiation and interpretation of this Agreement, and the other agreements or documents contemplated by this Agreement, the other Loan Documents and the Security and the administration of the Credit Facilities generally; (b) all expenses of advisors and consultants to the Agent and Lenders (including legal expenses on a full indemnity basis) incurred in connection with the protection and enforcement of this Agreement and prior agreements, the other Loan Documents and the Security, or in connection with any proceeding in respect of bankruptcy, insolvency, winding up, receivership, dissolution, reorganization, liquidation, moratorium, arrangement or assignment for the benefit of creditors involving any Credit Party, in each of the foregoing events whether under the Bankruptcy and Insolvency Act (Canada), the Companies' Creditors Arrangement Act (Canada), or United States Bankruptcy Code (11 U.S.C. §101 et seq.), or any similar federal, state, provincial or foreign bankruptcy, insolvency, reorganization, receivership or similar law. The Borrowers specifically authorizes the Agent to debit from any of the Borrowers' accounts

with the Agent the amount of any such existing and future fees and disbursements, and other expenses.

11.6 Survival of Representations and Warranties

All representations and warranties made in this Agreement or any other document delivered in connection with this Agreement will survive the execution and delivery of this Agreement and the other documents in accordance with the provisions of the *Limitations Act, 2002* (Ontario) and no investigation by the Agent or any Lender or any closing will affect the representations and warranties or the right of the Agent and Lenders to rely upon them.

11.7 Reviewed by Legal Counsel

Each Credit Party represents and warrants to the Agent and the Lenders that it:

- 11.7.1 understands fully the terms of this Agreement and the consequences of the execution and delivery of this Agreement;
- 11.7.2 has been afforded an opportunity to have this Agreement reviewed by, and to discuss this Agreement and any documents executed in connection herewith with, such lawyers and other persons as such Credit Party may wish; and
- 11.7.3 has entered into this Agreement and executed and delivered all documents in connection herewith of its own free will and accord and without threat, duress or other coercion of any kind by any Person. The parties hereto acknowledge and agree that neither this Agreement nor the other documents executed pursuant hereto will be construed more favourably in favour of one than the other based upon which party drafted the same, it being acknowledged that all parties hereto contributed substantially to the negotiation and preparation of this Agreement and the other documents executed pursuant hereto or in connection herewith.

11.8 Governing Law

This Agreement is governed by, and is to be construed and interpreted in accordance with, the laws of the Province of Ontario and the laws of Canada applicable in that Province.

11.9 Submission to Jurisdiction

Each of the Parties irrevocably submits and attorns to the non-exclusive jurisdiction of the courts of the Province of Ontario to determine all issues, whether at law or in equity arising from this Agreement. To the extent permitted by Applicable Law, each of the Parties irrevocably waives any objection (including any claim of inconvenient forum) to the venue of any legal proceeding arising out of or relating to this Agreement in the courts of that Province, or that the subject matter of this Agreement may not be enforced in those courts, and irrevocably agrees not to seek, and hereby waives any right to, judicial review by any court which may be called upon to

enforce the judgment of the courts referred to in this Section 11.9, of the substantive merits of any such suit, action or proceeding. To the extent a Party has or hereafter may acquire any immunity from the jurisdiction of any court or from any legal process (whether through service or notice, attachment prior to judgment, attachment in aid of execution, execution or otherwise) with respect to itself or its property, that Party irrevocably waives that immunity in respect of its obligations under this Agreement.

11.10 Mutual Waiver of Jury Trial

Because disputes arising in connection with complex financial transactions are most quickly and economically resolved by an experienced and expert person and the Parties wish applicable state/provincial and federal laws to apply (rather than arbitration rules), the Parties desire that their disputes be resolved by a judge applying those Applicable Laws. Therefore, to achieve the best combination of the benefits of the judicial system and of arbitration, the Parties waive all rights to trial by jury in any action, suit, or proceeding brought to resolve any dispute, whether arising in contract, tort, or otherwise between the Agent, the Lenders, the Borrowers and any other Credit Party, arising out of, connected with, or related or incidental to, the relationship established between them in connection with this Agreement or any of the Loan Documents or the transactions related to this Agreement or any of the Loan Documents.

11.11 Time of Essence

Time is of the essence in all respects of this Agreement.

11.12 Notices

Any Communication must be in writing and must be delivered in accordance with Section 13.15 of the Credit Agreement.

11.13 Further Assurances

Each Credit Party will, at its own cost, execute and deliver all further agreements and documents and provide all further assurances as may be reasonably required by the Agent to give effect to this Agreement and, without limiting the generality of the foregoing, will do or cause to be done all acts and things, execute and deliver or cause to be executed and delivered all agreements and documents and provide such assurances, undertakings and information as may be required from time to time by all regulatory or governmental bodies.

11.14 Amendment and Waiver

No supplement, modification, amendment, waiver, discharge or termination of this Agreement is binding unless it is executed in writing by the Party to be bound. No waiver of, failure to exercise or delay in exercising, any provision of this Agreement constitutes a waiver of any other provision (whether or not similar) nor does such waiver constitute a continuing waiver unless otherwise expressly provided.

11.15 Assignment and Enurement

Neither the Borrowers nor any other Credit Party will be entitled to assign this Agreement or any right or obligation under this Agreement without the prior consent of the Agent. The Agent may assign this Agreement and any of its rights and obligations under this Agreement in accordance with Section 18 of the Credit Agreement. This Agreement enures to the benefit of and is binding upon the Parties and their respective successors and permitted assigns.

11.16 Severability

Each provision of this Agreement is distinct and severable. If any provision of this Agreement, in whole or in part, is or becomes illegal, invalid or unenforceable in any jurisdiction by a court of competent jurisdiction, the illegality, invalidity or unenforceability of that provision will not affect:

- 11.16.1 the legality, validity or enforceability of the remaining provisions of this Agreement; or
- 11.16.2 the legality, validity or enforceability of that provision in any other jurisdiction.

11.17 Counterparts

This Agreement may be executed and delivered by the Parties in one or more counterparts, each of which when so executed and delivered will be an original and such counterparts will together constitute one and the same instrument.

11.18 Facsimile Signatures

Delivery of this Agreement by facsimile or "pdf" transmission constitutes valid and effective delivery.

- THE REMAINDER OF THIS PAGE HAS BEEN INTENTIONALLY LEFT BLANK -

Each of the parties has executed and delivered this Agreement as of the date first written above.

THE BORROWERS:

THANE DIRECT, INC.

Per _____
 Name:
 Title:

I have the authority to bind the Corporation.

THANE DIRECT COMPANY

Per _____
 Name:
 Title:

I have the authority to bind the Corporation.

THE OTHER CREDIT PARTIES:

THANE INTERNATIONAL, INC.

Per: _____
 Name:
 Title:

I have the authority to bind the Corporation.

DIRECT MARKETING HOLDINGS, INC.

Per: _____
 Name:
 Title:

I have the authority to bind the Corporation.

**THANE DUTCH HOLDINGS
 COOPERATIEF U.A.**

Per: _____
 Name:
 Title:

I have the authority to bind the Corporation.

**WEST COAST DIRECT MARKETING,
 INC.**

Per: _____
 Name:
 Title:

I have the authority to bind the Corporation.

- Signature 2 -

TDG INC.

THANE DIRECT CANADA INC.

Per: _____
Name:
Title:

Per: _____
Name:
Title:

I have the authority to bind the Corporation.

I have the authority to bind the Corporation.

THE LENDERS:

BANK OF MONTREAL

NATIONAL BANK OF CANADA

Per: _____
Name:
Title:

Per: _____
Name:
Title:

Per: _____
Name:
Title:

Per: _____
Name:
Title:

I/We have the authority to bind the Bank.

I/We have the authority to bind the Bank.

HSBC BANK CANADA

Per: _____
Name:
Title:

Per: _____
Name:
Title:

I/We have the authority to bind the Bank.

- Signature 4 -

THE AGENTS:

BANK OF MONTREAL, as Co-Lead
Arranger, Syndication Agent and
Administrative Agent

HSBC BANK CANADA, as Co-Lead Arranger
and Documentation Agent

Per: _____
Name:
Title:

Per: _____
Name:
Title:

Per: _____
Name:
Title:

Per: _____
Name:
Title:

I/We have the authority to bind the Bank.

I/We have the authority to bind the Bank.

SCHEDULE 1
EXISTING DEFAULTS SECTION 1.2

The following Defaults and Events of Default are existing and continuing:

1. Pursuant to Section 13.2 of the Credit Agreement, the Borrowers are obligated to repay a portion of the Outstanding Advances under Facility B by way of installment payments, payable quarterly in arrears on the last day of each Fiscal Quarter. An instalment payment in the amount USD \$3,750,000 was due and payable on each of September 30, 2013, December 31, 2013 and March 31, 2014. As of the date of this Agreement, the Borrowers have failed to make the required instalment payments in the aggregate amount of USD \$11,250,000 and expect not to make the required June 30, 2014 and September 30, 2014 instalment payments and, accordingly, Events of Default and a Default, as applicable, have occurred under Section 16.1 of the Credit Agreement.
2. The Borrowers are not in compliance with Sections 14.3.2 and 14.3.3 of the Credit Agreement for the periods ending September 29, 2013, December 31, 2013 and March 31, 2014 and expect not to be in compliance with such Sections for the periods ending June 30, 2014 and September 30, 2014 and, accordingly, Events of Default and a Default, as applicable, have occurred under Section 16.1 of the Credit Agreement.

SCHEDULE 2
EXISTING SECURITY

1. Guaranty by West Coast Direct Marketing, Inc. ("**West Coast**"), TDG, Inc. ("**TDG**"), Thane Direct, Inc. ("**Thane Direct US**"), Thane International, Inc. ("**Thane International**") and Direct Marketing Holdings, Inc. ("**Parent**") dated as of December 22, 2010 in favour of Bank of Montreal, as administrative agent (the "**Agent**").
2. Security Agreement between West Coast, TDG, Thane Direct US, Thane International and Parent and the Agent dated as of December 22, 2010.
3. Share Pledge Agreement between Thane Direct US, as pledgor, and the Agent re shares of Grupo Mejor Compra, S.A.P.I. de C.V. ("**Grupo**") dated December 22, 2010.
4. Agreement and Deed of Pledge of Cooperative Membership Rights between Thane Direct US and Thane International, as pledgors, and the Agent, re membership rights of Thane Dutch Holdings Coöperatief U.A. ("**Thane Netherlands**") dated December 22, 2010.
5. Agreement and Deed of Pledge of Cooperative Membership Rights (Subject to the Existing Pledges) between Thane Direct US and Thane International, as pledgors, and the Agent, re membership rights of Thane Netherlands dated September 28, 2012.
6. Guarantee by Thane Direct Company ("**TDC**") dated as of December 22, 2010 in favour of the Agent.
7. General Security Agreement between TDC and the Agent dated as of December 22, 2010.
8. Share Charge between TDC, as chargor, and the Agent dated December 22, 2010 relating to sixty-five percent of the issued share capital of Thane Direct UK Limited ("**Thane UK**").
9. Guarantee by Thane Netherlands dated as of December 22, 2010 in favour of the Agent.
10. Pledge Agreement between Thane Netherlands and the Agent dated as of December 22, 2010 re shares of TDC.
11. Guarantee by Thane Direct Canada Inc. ("**Thane Canada**") dated as of December 22, 2010 in favour of the Agent.
12. General Security Agreement between Thane Canada and the Agent dated as of December 22, 2010.
13. Notice of Intention under Section 427 of the *Bank Act* from Thane Canada in favour of the Agent dated December 21, 2010.

14. Application for Credit and Promise to Give Bills of Lading, Warehouse Receipts, or Security under Section 427 of the Bank Act from Thane Canada in favour of the Agent dated December 22, 2010.
15. Special Security Agreement under Section 427 of the *Bank Act* from Thane Canada in favour of the Agent dated December 22, 2010.
16. Agreement as to Loans and Advances and Security therefor under Section 427 of the *Bank Act* from Thane Canada in favour of the Agent dated December 22, 2010.
17. Assigned Account Agreement between Bank of Montreal and Thane Direct US, accepted by BMO Harris Bank N.A. on September 28, 2012.
18. Assigned Account Agreement between Bank of Montreal and Thane Direct Company, accepted by BMO Harris Bank N.A. on September 28, 2012.
19. Assignment of Account Receivable Insurance from Atradius Trade Credit Insurance, Inc. together with direction to pay documents as applicable dated December 15, 2010.
20. Warehouse Bailment addressed to Northland Fulfillment from Thane Canada, the Agent and RBC, acknowledged by Northland Fulfillment dated December 23, 2010, together with Fulfillment Center Agreement addressed to the Agent and RBC from Thane International, acknowledged and agreed to by the Agent, RBC and Innotrac Corporation dated December 23, 2010.

**SCHEDULE 3
LIST OF NON-LENDER ACCOUNTS**

COMPANY	DESCRIPTION	ACCOUNT No.	INSTITUTION	COUNTRY	CURRENCY DENOMINATION	PURPOSE
Thane Direct Company	Operating	80002 63059 11	Scotiabank (Canada)	Canada	USD	This bank account is used to receive funds from certain wholesale legacy customers who continue to use this bank account.
Thane Direct Marketing, Inc.	Operating	47696-1087215	Scotiabank (Canada)	Canada	CAD	Monthly payments to Great West Life. Account to be closed by May 31, 2014.
Thane Direct Canada	Depository Account	80002 11694 16	Scotiabank	Canada	CAD	This bank account is used to receive payments from DRTV customers in Canada who pay with an AMEX card. Amounts are transferred from this account to other accounts listed herein.
Thane Direct Canada Inc.	Operating Account	80002 11690 17	Scotiabank (Canada)	Canada	CAD	This bank account is used primarily to pay the CEO's Scotia credit card used for international travel.
Thane Direct Canada Inc.	Operating Account	80002 63702 13	Scotiabank	Canada	USD	This bank account is used to fund TDCI suppliers with US\$ invoices to TDCI.
Thane Direct Canada Inc.	Operating Account	80002 85488 11	Scotiabank	Canada	USD	This bank account is used as a flow through account "zero balance clearing account". Management advised this bank account is linked to a U.S. Bank for fast clearance of cheques, so this bank account was retained.
Thane Direct Inc.	Operating	1459460082	Bank of America	USA	USD	Account closed.
Thane International Inc.	Corporate Operating Account	1459102456	Bank of America	USA	USD	This bank account is used as a flow through account "zero balance clearing account". Management advised that this bank account will be closed shortly as not many disbursements go through this bank account any more.

COMPANY	DESCRIPTION	ACCOUNT NO.	INSTITUTION	COUNTRY	CURRENCY DENOMINATION	PURPOSE
Thane International Inc.	Depository Account	1459104511	Bank of America	USA	USD	This bank account is used for direct deposits from credit card companies – primarily Amex and Paypal (DRTV), as well as retail receipts. This account was originally set up to receive all U.S. customer receipts in a centralized account. Management advised it is inconvenient to change agreements with customers who directly deposit into this bank account.
Fox Marketing Associates, Inc.		1496302517	Bank of America	USA	USD	Account closed.
Thane International Inc.	Returned Items	1459105162	Bank of America	USA	USD	Account closed.
Thane International Inc.	Thane Distribution Group	1496802741	Bank of America	USA	USD	This bank account is used as a flow through account “zero balance clearing account”. This bank account is used primarily as a disbursement account for the U.S. Non-DRTV business.
Thane International Inc.	West Coast Account	1496502158	Bank of America	USA	USD	This bank account is used as a flow through account “zero balance clearing account”. This bank account is used primarily as a disbursement account for the U.S. DRTV business.
Thane International Inc.	General Account	1458327027	Bank of America	USA	USD	Account facilitated a prior blocked account agreement. This account currently exists in the flow between the Thane International Depository Account and the other US disbursement account. This account is in the process of being closed.
Thane International Inc.	Stock Escrow	1459922719	Bank of America	USA	USD	This bank account holds funds related to unclaimed shareholder proceeds from going private transaction.

COMPANY	DESCRIPTION	ACCOUNT No.	INSTITUTION	COUNTRY	CURRENCY DENOMINATION	PURPOSE
Thane International Inc.	Transaction Escrow	1459441258	Bank of America	USA	USD	Account closed.
Thane Direct Inc.	Pan European	1496902816	Bank of America	USA	USD	Account closed.

**SCHEDULE 4
FORM OF IRREVOCABLE PROXY**

IRREVOCABLE PROXY COUPLED WITH INTEREST

The undersigned stockholder hereby irrevocably designates and appoints Bank of Montreal, as "Agent" (as defined in the Security Agreement identified below), to represent it at all annual and special meetings of the stockholders of _____, a corporation organized under the laws of _____, and the undersigned hereby authorizes and empowers Bank of Montreal, as Agent, to vote any and all stock owned by the undersigned or standing in its name, and do all things which the undersigned might do if present and acting itself.

This proxy is an irrevocable proxy coupled with an interest. The undersigned recognizes that Bank of Montreal, as Agent, has an interest in said stock pursuant to that certain Security Agreement dated as of December 22, 2010 (the "**Security Agreement**") by and between the undersigned, certain affiliates of the undersigned, and Bank of Montreal, as Agent, to secure certain obligations owing to Secured Creditors (as defined in the Security Agreement) and, to the maximum extent permitted by law, this proxy shall continue in full force and effect until the obligations are paid in full notwithstanding any time limitations set forth in the bylaws or other organizational documents of Thane International, Inc., or the general corporation law of Delaware.

This proxy is issued pursuant to the Security Agreement and shall remain subject to the terms thereof; and Bank of Montreal, as Agent, shall not exercise any right or privileges granted therein unless and until the occurrence of any of the events set forth in Section 8 of the Security Agreement which authorizes the voting of the stock pursuant to this proxy.

Dated: _____, 2014

●,
a _____ corporation

By:

Name:

Title:

**SCHEDULE 5
FORM OF ACKNOWLEDGMENT**

ACKNOWLEDGMENT

The undersigned hereby (i) acknowledges receipt of a copy of the Security Agreement dated as of December 22, 2010 (the "**Security Agreement**") by and between WEST COAST DIRECT MARKETING, INC., a California corporation ("**West Coast**"), TDG, INC., a Delaware corporation ("**TDG**"), THANE DIRECT, INC., a Delaware corporation ("**Thane Direct US**"), THANE INTERNATIONAL, INC., a Delaware Corporation ("**Thane International**") and DIRECT MARKETING HOLDINGS, INC., a Delaware corporation ("**Direct Marketing**"), and Bank of Montreal, as Agent (the "**Agent**"), (ii) acknowledges receipt of the Irrevocable Proxy Coupled with Interest dated _____, 2014 (the "**Irrevocable Proxy**") from Direct Marketing to the Agent, (iii) waives any rights or requirement at any time hereafter to receive a copy of the Security Agreement in connection with the registration of any Subsidiary Interests (as defined therein) in the name of the Agent or its nominee or the exercise of voting rights by the Agent and (iv) agrees promptly to note on its books and records the grant of the security interest in the stock of the undersigned, including the voting rights, as provided in the Security Agreement and to recognize all of the rights of the Secured Party under the Security Agreement, including the voting rights.

Dated: _____, 2014

●

By:

Name:
Title:

SCHEDULE 6

SISP

See attached.

**SCHEDULE 7
DEMAND LETTER AND SECTION 244 NOTICES**

See attached.

TOR_LAW\ 8420602\6

TAB G

THIS IS EXHIBIT "G"
TO THE AFFIDAVIT OF PAUL FINDLAY
SWORN BEFORE ME THIS 16TH DAY
OF OCTOBER, 2015.



A Commissioner for Taking Affidavits

Clifton P. Prophet

STRICTLY PRIVATE AND CONFIDENTIAL

May 22, 2015

To: Amir Tukulj and Russel Orelowitz
c/o Suite 501
5255 Orbitor Drive
Mississauga, Ontario
L4W 5M6

Dear Sirs:

Re: Proposed Purchase of Assets of Thane

This letter of intent ("**Letter of Intent**") is further to the discussions to date between Bank of Montreal, HSBC Bank Canada and National Bank of Canada (collectively, the "**Lenders**") and Amir Tukulj and Russel Orelowitz, on behalf of themselves and other members of management and a Canadian entity or entities to be formed or incorporated (collectively, the "**Shareholder**") and further to the amended and restated forbearance agreement between, *inter alia*, the Lenders, Thane Direct, Inc. and Thane Direct Company dated as of May 26, 2014 as amended by a first amending agreement dated as of August 14, 2014 and a second amending agreement dated March 2, 2015 (collectively, the "**Forbearance Agreement**"). For greater certainty, nothing in this Letter of Intent will amend or otherwise vary the terms and conditions of the Forbearance Agreement.

The provisions of this Letter of Intent will confirm the intention of the parties with respect to:

- (a) the initial subscription by each of the Shareholder and the Lenders for their respective equity interests (as to 35% to the Lenders and as to 65% to the Shareholder) in a Canadian entity or entities to be formed or incorporated ("**Buyer**") (the "**Subscription Transaction**");
- (b) the rights and obligations of the Shareholder and the Lenders as equity holders of the Buyer (the "**Equity Transaction**");
- (c) the Buyer's purchase of all or substantially all of the assets of Thane International, Inc. ("**International**"), Thane Direct, Inc. ("**TDI**") and Thane Direct Company (which may include the assets or shares of their subsidiaries) ("**TDC**") and together with International and TDI, collectively "**Thane**") (the "**Sale Transaction**");
- (d) the operating and term loans by the Lenders to the Buyer, the particulars of which are described below (the "**Senior Loan Transaction**"); and

- (e) the \$2,000,000 term loan by the Shareholder to the Buyer, the particulars of which are described below (the “**Management Loan Transaction**”).

The Subscription Transaction, the Equity Transaction, the Sale Transaction, the Senior Loan Transaction and the Management Loan Transaction are collectively referred to herein as the “**Proposed Transactions**”. With respect to the Senior Loan Transaction, the Lenders will also provide a separate term sheet to the Buyer.

The purpose of this Letter of Intent is to describe in broad terms the basis upon which the Lenders and the Shareholder are prepared to complete the Proposed Transactions by setting out certain non-binding understandings in Articles One through Seven below (the “**Non-Binding Provisions**”) and certain binding obligations in Articles Eight through Eleven below (the “**Binding Provisions**”) between the Lenders and the Shareholder. It is the intention of the Lenders and the Shareholder to cause the Buyer, upon its formation or incorporation, to fulfill all covenants and obligations of the Buyer set out in this Letter of Intent.

ARTICLE ONE NON-BINDING PROVISIONS

Section 1.01 Intent of Non-Binding Provisions

The Non-Binding Provisions of this Letter of Intent are intended only to outline the principal terms and conditions upon which the parties will attempt to negotiate the Proposed Transactions and do not create or constitute any legally binding obligations between the parties, nor impose any liability on any party to another.

ARTICLE TWO DEFINITIVE AGREEMENTS

Section 2.01 Definitive Agreements

The precise terms and conditions of the understandings and obligations of the parties relating to the Proposed Transactions will be contained in the followings definitive agreements (collectively, the “**Definitive Agreements**”) agreed to by the parties:

- (a) A subscription agreement between the Lenders or any nominee of the Lenders (the “**Lender Nominee**”) and the Buyer in respect of the Subscription Transaction (the “**Subscription Agreement**”);
- (b) A shareholders agreement with respect to the Buyer, between the Shareholder, the Lenders (or Lender Nominee) and the Buyer (the “**Shareholders Agreement**”);
- (c) An asset purchase agreement (the “**Purchase Agreement**”) between the Buyer as purchaser and Richter Advisory Group Inc. as receiver of Thane and, if applicable, the U.S. Entities (as defined hereafter) appointed pursuant to a Receivership Order (as described in Section 7.03(g) herein), as seller (the “**Seller**”);

- (d) A loan agreement between the Lenders and the Buyer in connection with a term loan facility in the principal amount of \$50,000,000 and an operating facility in the maximum principal amount of \$6,000,000 (the “**Senior Loan Agreement**”), together with the security and other related documents required under the Senior Loan Agreement (the “**Senior Security**”); and
- (e) A loan agreement between the Shareholder and the Buyer in connection with a term loan in the principal amount of \$2,000,000 (the “**Management Loan Agreement**”), together with the security and other related documents required under the Management Loan Agreement (the “**Management Security**”).

Section 2.02 **Drafting Responsibility**

The Lenders and their legal counsel, Gowlings LLP (“**Gowlings**”), will be responsible for preparing the drafts of the Definitive Agreements. Except with respect to the Surviving Binding Provisions (as defined below), no party will have any liability to any other party if any of the Definitive Agreements is not prepared, authorized, executed or delivered for any reason.

ARTICLE THREE SALE TRANSACTION

Section 3.01 **Assets to be Acquired**

On or before July 31, 2015 or such other date as mutually agreed to by the parties in writing (the “**Closing Date**”), the Buyer will purchase from the Seller all or substantially all of the assets used in connection with the business and operations of Thane and its subsidiaries and affiliates (the “**Thane Business**”), including the following (the “**Purchased Assets**”):

- (a) Except as set out below in Section 3.02(a), all of the issued and outstanding shares of each subsidiary (or substantially all of the assets of such subsidiary in lieu of the shares of such subsidiary) of International, TDC and TDI that are owned by International, TDC and TDI;
- (b) All contracts, licences and leases for the operation of the Thane Business;
- (c) All equipment used in the Thane Business;
- (d) All intellectual property of Thane or used in the Thane Business.

Section 3.02 **Excluded Assets**

The offer to purchase the Purchased Assets does not include the following assets or liabilities (the “**Excluded Assets**”):

- (a) The issued and outstanding shares of TDI, TDC and such other entities identified prior to the Closing Date by the Buyer and as agreed to by the Lenders;

- (b) Assets and liabilities identified prior to the Closing Date by the Buyer and as agreed to by the Lenders; and
- (c) Tax liabilities of the entities whose share equity is not being acquired by the Buyer.

Section 3.03 **Purchase Price**

The consideration for the Purchased Assets will be as follows:

- (a) The Buyer will pay a purchase price to the Seller in the aggregate amount of \$50,000,000 (the "**Purchase Price**");
- (b) Other than as described in Section 3.02, the Buyer will assume all existing liabilities of TDC and TDI; and
- (c) Other than as described in Section 3.02, the Buyer will assume all existing contract obligations (including warranty obligations), trade liabilities and other contingent liabilities of Thane.

Section 3.04 **Subscription**

Pursuant to the Subscription Agreement, the Lenders or the Lender Nominee will acquire (for nominal consideration) an initial 35% equity interest in the Buyer, further particulars of which will be set out in the Shareholders Agreement.

Section 3.05 **Employees**

The Seller will terminate the employment of all employees of TDI, TDC, International and if applicable, the U.S. Entities (as defined herein) and the Buyer will offer employment to those employees on substantially similar terms and conditions including the assumption of severance liabilities. All salaries and other compensation obligations for such employees must be fully paid and current as at the Closing Date.

Section 3.06 **"As is, Where is"**

The Sale Transaction will be on an "as is, where is" basis and the Purchase Agreement will not include any representations and warranties of the Seller, other than the standard representations given by a court-appointed receiver acting as a seller of assets of a business.

ARTICLE FOUR SENIOR LOAN TRANSACTION

Section 4.01 **Senior Loan Agreement**

The Lenders will enter into a new loan agreement with the Buyer for a term loan facility and an operating loan facility (collectively, the "**Senior Indebtedness**"), on similar terms and conditions as the Existing Loan Agreement, which (having regard for Thane's current financial

situation) are to be negotiated, including financial covenants that are supported by Thane's and the Buyer's financial forecasts.

Section 4.02 Term Loan

The Lenders will establish a new term loan facility in the principal amount of \$50,000,000 (the "**Term Loan**") which will be used to fund the Purchase Price. The Term Loan will be deemed to be have been fully advanced as at the Closing Date. The Term Loan will include the following provisions:

- (a) The term of the loan and the amortization period will be 8 years.
- (b) The interest rate is to be set at either a floating or fixed rate and will be established by mutual agreement of the parties based on current practice under the Existing Loan Agreement and then existing market conditions.
- (c) The Term Loan will be repaid by the Buyer as follows:
 - (i) 5% of the original principal balance of \$50,000,000 to be repaid in year 1,
 - (ii) 10% of the original principal balance to be repaid in year 2,
 - (iii) 13.4% of the original principal balance to be repaid in each of year 3 through to year 7,
 - (iv) and 18% of the original principal balance to be repaid in year 8.
- (d) If the Term Loan is repaid or refinanced in full prior to the end of fiscal year 7, the Shareholder is entitled to receive from the Buyer the following incentive payments ("**Early Payment Incentive**"):
 - (i) Payment in the amount of \$2,000,000 if the Term Loan is repaid or refinanced in full by the end of year 5;
 - (ii) Payment in the amount of \$1,000,000 if the Term Loan is repaid or refinanced in full after the end of year 5 but before the end of year 7.

The Early Payment Incentive will be funded as a separate bonus to the Shareholder (i.e. not part of existing bonus pool) after the Term Loan is repaid or refinanced in full.

- (e) At any time, the Shareholder has the discretion to utilize Free Cash Flow to reduce the Senior Loan without any prepayment penalty.

"Capex" means all expenditures made for the purchase, lease, licence or acquisition of assets (other than current assets) required to be capitalized in accordance with GAAP, including equipment, rolling equipment, machinery and other fixed assets and real property.

“EBITDA” shall have substantially the same meaning as set out in the Existing Credit Agreement, as follows:

“EBITDA” means, for any period, the Net Income for such period (exclusive of all extraordinary and non-recurring items, if such non-recurring items are approved by the Agent, acting reasonably) plus the aggregate (without duplication) of the following, in each case for [the Buyer] on a consolidated basis:

- (a) Interest Expense;
- (b) Income Tax Expense;
- (c) depreciation and amortization expense;
- (d) all fees paid or payable to the Agent and the Lenders;
- (e) non-cash purchase accounting adjustments;
- (f) non-cash charges with respect to losses arising from Hedging Arrangements;
- (g) non-cash charges with respect to employee and management stock option compensation;
- (h) any costs and expenses borne by the Buyer incurred in connection with the Proposed Transactions;

and less:

- (i) non-cash gains arising from Hedging Arrangements,

in each case to the extent such amounts were deducted in the calculation of Net Income for such period, all determined on a consolidated basis and in accordance with GAAP.

“Free Cash Flow” means EBITDA, less Capex, less interest, cash taxes and debt amortization.

“Total Debt” means (i) obligations for borrowed money, (ii) obligations evidenced by a note, bond, debenture or other similar instrument, (iii) obligations for the deferred purchase price of property or services, excluding trade payables and other accrued current liabilities incurred in the ordinary course of business in accordance with customary commercial terms, (iv) a capitalized lease obligation, (v) a guarantee, indemnity, or financial support obligation, determined in accordance with GAAP, (vi) obligations secured by a lien or charge on any property of such person, or (vii) obligations arising in connection with an acceptance facility or letter of credit issued for the account of such person.

“**TTM EBITDA**” means EBITDA for the trailing twelve month period, as at the date of calculation.

- (f) Free Cash Flow that is not used to reduce the Term Loan, pay permitted dividends, pay the Early Incentive Payment and/or buy-back any of the Lenders’ equity shall be reinvested in the business and operations of the Credit Parties (as hereafter defined) to enhance liquidity, subject to agreed investment restrictions, which will include the following:
- (i) the Buyer shall not, nor shall it permit any of the Buyer Group (as defined below) to, make any investments in: (I) speculative or volatile financial investments (i.e. investments that are not designated “legal for life”); and (II) non-core assets (businesses that are currently not a primary component of the Thane Business and/or their subsidiaries and affiliates; and
 - (ii) the Buyer Group may make investments, without the prior written consent of the Lenders, in businesses that are in the nature of the Thane Business and the business currently conducted by their subsidiaries, and affiliates and where the effective value of the purchase price of such investment, whether cash or non-cash (including debt, share swap or otherwise), does not exceed an aggregate amount of \$2,000,000 per annum. Once the Term Loan has been repaid in full, this limit will increase to an aggregate amount of \$4,000,000 per annum.

“**Buyer Group**” means the Buyer and each of its direct and indirect subsidiaries.

Section 4.03 **Operating Loan**

The Lenders, except for HSBC Bank Canada (collectively, the “**Operating Lenders**”) will establish a new operating loan up to a maximum principal amount of \$6,000,000 (the “**Operating Loan**”) on terms that will include the following:

- (a) The interest rate will be at a rate consistent with normal terms and conditions related to an ordinary going-concern operating loan with a borrowing base margin;
- (b) The Operating Lenders shall have a first ranking charge on accounts receivable and inventory (the “**Operating Security**”);
- (c) The outstanding operating loan under the Existing Loan Agreement will not be assumed by the Buyer, except for that portion, if any, that is in excess of \$8,000,000, which will be deemed to be an advance under the Operating Loan.
- (d) The Buyer shall have the ability to seek alternate arm’s length financing for any of its international operating subsidiaries which are not now subject to the Senior Security, in order to reduce its reliance on the Operating Loan (for example, factoring and other facilities). For greater certainty, no such financing shall be permitted if the Buyer or any subsidiary/affiliate of the Buyer which has granted

Senior Security is being asked to provide a guarantee or other financial assistance in support of such alternate financing.

Section 4.04 Covenants

Similar to the Existing Loan Agreement, the Senior Loan Agreement will include standard positive and negative covenants for commercial loans to entities engaged in a similar businesses which will be negotiated (having regard for Thane's current financial situation), including financial covenants that are supported by Thane's and the Buyer's financial forecasts, and will include the following:

- (a) Any investment in Capex or production costs for marketing purposes that is in excess of \$1,000,000 over the annual operating budget, is to be pre-approved in writing by the Lenders and such approval shall be given or withheld by the Lenders within ten (10) business days of the Lenders receiving such approval request from the Buyer, provided that if the Lenders fail to respond within such time period, approval is deemed to have been given;
- (b) No material change to existing compensation plans for the Thane Business, including the calculation of the amount set aside for the existing bonus pools which are evidenced by written contracts in existence as at the date hereof and which have been previously provided to the Lenders;
- (c) The Buyer shall provide annual operating budgets to the Lenders, which must be acceptable to the Lenders;
- (d) The Buyer shall deliver interim and annual audited financial statements to the Lenders with the timeframes agreed to by the parties; and
- (e) Presentation of a 13 week rolling cash flow forecast until the ratio of Total Debt to TTM EBITDA is lower than 3:1.

Other specific covenants are to be negotiated between the parties, having regard for the Buyer's current financial situation, including financial covenants that are supported by the Buyer's financial forecasts.

Section 4.05 Senior Security

The Buyer, together with any subsidiaries and affiliates of the Buyer required by the Lenders (collectively, the "Credit Parties"), shall, but subject to Section 4.03(d), provide the relevant guarantees, security and other agreements necessary to grant the Lenders a first priority lien and charge over all the assets, property and undertaking of the Credit Parties, including the Operating Security. The Senior Security shall be in substantially the same form as the security granted to the Lenders under the Existing Loan Agreement. Further, the Buyer and the Credit Parties shall, but subject to 4.03(d), provide, or cause to be provided, such further and other guarantees and security as the Lenders deem necessary or desirable in the circumstance.

ARTICLE FIVE MANAGEMENT LOAN TRANSACTION

Section 5.01 Management Loan Agreement

The Shareholders will advance a shareholders loan to the Buyer in the principal amount of \$2,000,000 (the "**Management Loan**"). The Management Loan will be on a *pari-passu* basis with the Senior Term Loan. Interest payments and repayment of the principal of the Management Loan will be on the same terms and conditions as set out for the Term Loan. For the avoidance of doubt, the Management Loan will be amortized in the same fashion and on the same percentage basis as the Term Loan.

Section 5.02 Management Security

The Management Loan will be secured by the Senior Security, provided that the Shareholder will not have any enforcement rights, and the Lenders and the Shareholder will enter into a security sharing agreement reflecting this arrangement ("**Management Security**"). The Shareholder will share in any realization on the Senior Security on a *pari passu* basis, except with respect to the Operating Security which shall have first priority over the Management Security.

ARTICLE SIX EQUITY TRANSACTION

Section 6.01 Subscription Transaction

Prior to the execution and delivery of the Shareholders Agreement, the Lenders and the Shareholder shall take all steps required to incorporate and organize the Buyer, including the initial subscription by each of the Lenders (or Lender Nominee) and the Shareholder for their 35% and 65% equity interests, respectively, in the capital of the Buyer. The exact nature of the equity interest is to be determined, but regardless of the form of the equity interest, the relative ownership percentages as between the Shareholder and the Lenders will be 65% to 35% until a Senior Repayment Event (as defined hereafter) occurs, and thereafter the respective ownership percentage of the Shareholder will be 80% and 20% for the Lenders.

Section 6.02 Shareholders Agreement

Prior to the execution and delivery by the Lender Nominee and the Buyer of the Purchase Agreement, each of them will enter into the Shareholders Agreement which will govern the equity ownership of the Buyer and the rights and obligations of the parties with respect to the Buyer. The Shareholders Agreement will include the following provisions:

- (a) **Initial Ownership Percentages.** Until the Term Loan is repaid in full or refinanced, the Shareholder will hold 65% of the equity interests in the Buyer and the Lenders (or Lender Nominee) will hold 35%.
- (b) **Senior Loan Repayment Event.** Once the Term Loan has been repaid in full or refinanced in full (the "**Senior Loan Repayment Event**"), the Shareholder's

equity interest in the Buyer will increase to 80% and the Lenders' equity interest will reduce to 20%.

- (c) **Lenders to Maintain 20% interest.** The Lenders will hold their 20% equity interest until such time as the Lenders execute, at their option, the Buyback Option (as described below).
- (d) **Buyer Board.** The Board of Directors of the Buyer (the "**Buyer Board**") will be fixed at three (3) directors, of which the Lenders, at their sole election, will be granted: (i) one voting position on the Buyer Board, (ii) a non-voting seat on the Buyer Board, or (iii) observer status on the Buyer Board.
- (e) **Lenders' Equity Interest Less Than 10%.** In the event that the Lenders collectively cease to hold 10% or more of the issued and outstanding shares in the capital of the Buyer on a fully diluted basis, then: (i) the Lenders will cease to have a seat or observer status, as applicable, on the Buyer Board, (ii) the Lenders' approval will no longer be required for the Buyer annual budgets and (iii) certain shareholder agreement covenants then in effect will be terminated, which will be negotiated in good faith as a part of the Shareholders Agreement.
- (f) **Items for Approval of Lenders.** The prior written consent of the Lenders will be required before certain fundamental matters may be approved, with such matters to be negotiated.
- (g) **No "Sunset" on Equity Ownership.** The Lenders, at their option, may retain their equity interest in the Buyer in perpetuity and be partners in the Buyer and its business with the Shareholder on dividend distributions and/or a sale of the Buyer business.
- (h) **Tag Along and Drag Along Rights.** The Lenders will have tag along rights and the Shareholder will have drag along rights with respect to the Lender's equity in the event of a sale of the Buyer business or change in control of the Buyer. In order for such drag along right to be enforceable by the Shareholder, the proposed sale or change of control of the Buyer must be to a bona fide arm's length party and the consideration to be paid for the shares of the Buyer must consist solely of cash, cash equivalents, publicly traded securities on a Canadian, U.S. or U.K. securities exchange (subject to any regulatory restrictions affecting the Lenders), or as otherwise agreed by the Lenders. A transaction where any Shareholder or Buyer Management receives material financial and/or non-financial compensation outside of the payment of the purchase price (including, without limitation, a "stay bonus", incentive payment or any other payment to a Shareholder whatsoever that is not consistent with the then-existing compensation received by such Shareholder from the Buyer) will be considered a "non-arm's length" transaction.
- (i) **No Separation of Debt and Equity.** The Lenders will not be permitted to sell only their equity interest in the Buyer prior to the occurrence of the Senior Loan Repayment Event without the consent of the Shareholder. The Lenders may, at

their option, sell the Term Loan and the Operating Loan together with the Lenders' equity interest without the consent of the Shareholder and the Buyer. After the Senior Loan Repayment Event has occurred, the Lenders may, at their option, sell their equity interest in the Buyer subject to a "Right of First Refusal" in favour of the Shareholder, on standard commercial terms, as agreed to by the parties and set out in the Shareholders Agreement. Any successful purchaser of the Term Loan, the Operating Loan and/or the Lenders' equity interest will be bound by the terms of the Senior Loan Agreement, the other loan documents and the Shareholders Agreement, as applicable.

- (j) **Buy Back Option.** If the Lenders notify the Shareholder and the Buyer that they wish to reduce some or all of their equity interest in the Buyer, the Buyer will enter into a share buy-back arrangement that will be triggered, at the option of the Lenders, at any time after the Senior Loan Repayment Event (the "**Buy-Back Option**"). The Buy-Back Option may be exercised by the Lenders upon written notice to the Shareholder and the Buyer that is delivered within 45 days of the date that the Lenders receive the year-end audited financial statements of the Buyer. Once the Lenders exercise this option, the Lenders will have the ability to defer the buy-back of their remaining equity interests in subsequent years, if the Lenders provide notice to the Shareholder and the Buyer within the 45 day period after the delivery of the audited financial statements to the Lender, in any given year of election. The Lenders may elect to have as many deferrals thereafter as they choose, until such time as all of the Lenders' equity is repurchased in full. The formula for each year's share buy-back will be as follows:
- (i) the Buyer may allocate up to 50% of Free Cash Flow as dividends to the Shareholder and the Lenders based on the ownership allocation at year end (i.e. prior to the share buyback), if triggered. A minimum of 50% of Free Cash Flow must be allocated to any share buy-back.
 - (ii) The share price to be used in the buy-back of any remaining equity interests held by the Lenders, which will be (in aggregate) 20% at the exercise of the Buy-Back Option, will be determined based on the following:
 - (A) EBITDA (for the just completed fiscal year) * 3 (multiple)
 - (B) Less: Outstanding debt
 - (C) Plus: Cash (not allocated for dividends)
 - (D) Equals = Equity Value
 - (E) Share Price : Equity Value / All outstanding shares
 - (iii) The parties agree that there will be no "cap" on the amount received by the Lenders pursuant to the exercise by the Lenders of the Buy-Back Option, notwithstanding that the Lenders may achieve a recovery in excess of the

original outstanding indebtedness owed to the Lenders under the Existing Loan Agreement.

- (iv) This buy-back mechanism will not have any flip protection, as it will be exercised solely by the Lenders. The Shareholder will not have any call on the Lenders' shares. Notwithstanding anything else in this Letter of Intent, nothing precludes the Lenders and the Shareholder, from time to time, from negotiating a buy-out of the remaining shares held by the Lenders.
- (v) The buy-back mechanism may be exercised by the Lenders from time to time until all of the Lenders' equity interests have been repurchased by the Buyer.
- (k) **Anti-Dilution.** The Buyer will not be permitted to allot or issue debt or equity securities or securities convertible into debt or equity securities which would result in a dilution of the equity interests held by the Lenders. For greater certainty, at all times prior to a Senior Loan Repayment Event, the Lenders (or Lender Nominee) shall hold 35% of the equity interests of the Buyer on a fully diluted basis and at all times after a Senior Loan Repayment Event, the Lenders (or Lender Nominee) shall hold 20% of the equity interests of the Buyer on a fully diluted basis (as such 20% may be reduced from time to time by the exercise of the Buy-Back Option, which reduced shareholdings shall also not be diluted in any manner).

Section 6.03 **Dividends**

- (a) After the first fiscal quarter after the completion of the Sale Transaction, where the Buyer has achieved a Total Debt to TTM EBITDA ratio of 2:1 or lower, the Buyer will, at its option, have the ability to pay dividends from Free Cash Flow. To the extent that this ratio is being measured in reliance on unaudited interim financial statements, the unaudited interim financial statements from which such ratio is being measured shall be presented to the Lenders in a manner which in form and substance is consistent with the audited financial statements.
- (b) Dividends, if and when declared, will be paid by the Buyer on the following basis:
 - (i) Until the Term Loan is repaid or refinanced in full, 65% to the Shareholder and 35% to the Lenders;
 - (ii) Once the Senior Loan Repayment Event has occurred, 80% to the Shareholder and 20% to the Lenders unless the Lenders' equity has been reduced by exercise of the Buy-Back Option;
 - (iii) Notwithstanding (i) and (ii) above, in the event that:
 - (A) there will be a Senior Loan Repayment Event; and

- 13 -

(B) immediately after such Senior Loan Repayment Event the net cash balance (after deducting all outstanding borrowings if not already deducted) will be positive, (a **“Positive Net Cash Balance”**), provided that Positive Net Cash Balance will also include a holdback of \$3,000,000 to take into account the working capital requirements of the Buyer’s subsidiaries,

then the Positive Net Cash Balance will be declared as a dividend and paid out by the Buyer immediately prior to the Senior Repayment Event. The Lenders will receive a dividend equal to 35% of the Positive Net Cash Balance and the Shareholder will receive a dividend equal to 65% of the Positive Net Cash Balance.

ARTICLE SEVEN CLOSING AND CONDITIONS OF CLOSING

Section 7.01 Closing Date

The parties intend that the Closing Date will occur no later than August 14, 2015.

Section 7.02 Existing Loan Agreement and Security

On the closing of the Sale Transaction, the entire Purchase Price will be directed through the Seller to repay the outstanding indebtedness of TDC and TDI under their existing amended and restated loan agreement dated as of September 28, 2012 with the Lenders (the **“Existing Loan Agreement”**) and the Lenders will release the parties thereto from their respective guarantees and all security granted to the Lenders in connection therewith.

Section 7.03 Conditions Precedent to Closing

The closing of the Sale Transaction will be on an “as is, where is” basis subject to the following additional conditions of closing in favour of the Lenders, the Buyer and the Shareholder, all of which will be included in the Purchase Agreement, including the following:

- (a) the Lenders, the Buyer and the Shareholder will have reviewed the proposed tax structure of the Buyer and the Buyer Group and the tax consequences with their respective tax and legal advisors and shall be satisfied with such tax structure and tax consequences;
- (b) the Subscription Agreement has been finalized between the Lenders (or Lender Nominee) and the Buyer;
- (c) the Shareholders Agreement has been finalized between the Lenders (or Lender Nominee), the Shareholder and the Buyer;
- (d) the Purchase Agreement has been finalized between the parties;

- 14 -

- (e) the Senior Loan Agreement and the Senior Security have been finalized between the Lenders and the Buyer;
- (f) the Management Loan Agreement and Management Security have been finalized between the Shareholder and the Buyer; and
- (g) either:
 - (i) the shareholders of each of International, TDI and TDC have approved and consented to the Sale Transaction; or
 - (ii) the Lenders have successfully obtained the following court orders:
 - (A) an order under section 243 of the BIA and Section 101 of the *Courts of Justice Act* for the appointment of the Seller as receiver over the property and assets of Thane and if applicable, certain other U.S. subsidiaries of International and/or TDI as identified by the Shareholder, acting reasonably (the “**U.S. Entities**”) as being necessary in order for the Sale Transaction to comply with applicable tax law in the U.S. (the “**Receivership Order**”);
 - (B) an order under the BIA approving the Sale Transaction (the “**Cdn. Approval & Vesting Order**”).
 - (C) a recognition order under Chapter 15 of the United States Bankruptcy Code (the “**Bankruptcy Code**”) recognizing the Receivership Order with respect to International and TDI and the U.S. Entities (the “**Recognition Order**”); and
 - (D) as soon as practicable after the granting of the Recognition Order, an order under the Bankruptcy Code approving the Sale Transactions (the “**US Approval & Vesting Order**”). The parties acknowledge that the timeframe for obtaining the US Approval & Vesting Order is anticipated to be within sixty (60) days of the granting of the Recognition Order.

ARTICLE EIGHT BINDING PROVISIONS

Section 8.01 **Binding Provisions**

In recognition of the significant costs to be borne by each of the parties in pursuing the Proposed Transaction, and in consideration of their respective undertakings as to the matters described in this Letter of Intent, the Binding Provisions will be legally binding upon execution and delivery of this Letter of Intent. Sections 9.01 through 9.04 of the Binding Provisions (the “**Surviving Binding Provisions**”) survive if this Letter of Intent is terminated. Sections 10.01 through 10.03

of the Binding Provisions (the “**Non-Surviving Binding Provisions**”) terminate upon the termination or expiration of this Letter of Intent.

ARTICLE NINE SURVIVING BINDING PROVISIONS

Section 9.01 Confidentiality

- (a) Except as may be required by law, the Shareholder will not, and will not allow any of its representatives or advisors to collect, disclose, or use, any Confidential Information (as defined below) at any time or in any manner, except for the purpose of evaluating the Proposed Transactions and except to carry out their duties and functions, whether as officers, directors or employees of Thane and its subsidiaries. For the purposes of this Letter of Intent, “**Confidential Information**” means any information relating to the Proposed Transactions, including information relating to identifiable individuals (“**Personal Information**”), whether communicated in written form, orally, visually, demonstratively, technically or by any other electronic form or other media, or committed to memory, but excluding information, other than Personal Information, which:
- (i) was available to or known by the public before the date of this Letter of Intent;
 - (ii) was or is obtained from a source other than the Seller, the Lenders or any person bound by a duty of confidentiality to the Seller or the Lenders; or
 - (iii) is or becomes available to or known by the public other than as a result of improper disclosure by the Shareholder or any of its representatives, advisors or lenders.
- (b) If this Letter of Intent is terminated under Section 10.03 below, the Shareholder, or any of its representatives, advisors or lenders, as applicable, will promptly return to the Seller any Confidential Information in its possession.

Section 9.02 Public Announcements

Neither the Shareholder nor the Lenders will make any public announcement concerning the Proposed Transactions or related negotiations without the parties’ prior written approval, except as may be required by law. Where a public announcement is required by law, the party required to make the announcement will inform the other parties of the contents of the proposed announcement and will make reasonable efforts to obtain the other parties’ approval for the announcement, which approval may not be unreasonably withheld.

Section 9.03 No Reliance

The Shareholder acknowledges that the Seller does not make any express or implied representation or warranty as to the accuracy or completeness of the Confidential Information or

any other information concerning the Seller that is provided to or gathered by the Shareholder, and agrees that the Seller will not have any liability, direct or indirect, to the Shareholder or any of its representatives, advisors or lenders relating to or resulting from the Confidential Information or that other information, or the use by the Shareholder of the Confidential Information or that other information, or reliance on any errors in or omissions from the Confidential Information or that other information, except in accordance with any specific representation or warranty made in any definitive agreement entered into in respect of the Proposed Transaction.

Section 9.04 Responsibility for Fees and Costs

All costs and expenses (including legal, accounting and other professional fees and disbursements) related to the Proposed Transactions (including this Letter of Intent) shall be paid from the outstanding operating loan under the Existing Loan Agreement prior to the closing. It is the intention of the Shareholder to work with Richter Advisory Group Services Inc. to manage the numerous professionals in Canada and the U.S. that will be involved in this matter. The Shareholder and the Lenders will establish and agree on a budget for the planned execution of the Proposed Transactions. This budget is expected to be \$1,500,000. It is the intention of the Shareholder to monitor this budget for fees and expenses on a frequent basis and report back to the Lenders if there will be a material change in the budget. All parties will use commercially reasonable efforts to minimize any and all such costs and expenses and the Shareholder appreciates that the Proposed Transactions are complex and require negotiations. It is not the intention of the Shareholder to restrict professional fees and expenses to the budget if incurring additional costs in excess of the budget are required, as long as those costs have been communicated and approved by the Lenders and the Shareholder prior to the excesses being incurred.

ARTICLE TEN NON-SURVIVING BINDING PROVISIONS

Section 10.01 No Negotiations with Other Parties

The Lenders acknowledge that the Shareholder will be incurring substantial costs, directly and indirectly, in evaluating and investigating the Proposed Transactions. In consideration of the Shareholder doing so, and in consideration of its execution of this Letter of Intent, the Lenders agree that from the date of this Letter of Intent until the earlier to occur of (i) the date that this Letter of Intent is terminated in accordance with Section 10.03, or (ii) August 14, 2015, they will not enter into or continue negotiations or discussions with any third party, in any manner, in respect of the sale of Thane, the Thane Business or any part of the Thane Business, or in respect of any other transaction which would be inconsistent with the matters contemplated by this Letter of Intent.

Section 10.02 Conduct of Business

Until the Definitive Agreements have been prepared, authorized, executed and delivered by all of the parties, or the Letter of Intent has been terminated under Section 10.03, the Shareholder will conduct the Thane Business only in the ordinary course, and will not engage in any extraordinary transactions without the Lenders' prior written consent.

Section 10.03 Termination

- (a) This Letter of Intent will be terminated:
- (i) If the approval(s) set out in Section 7.03(g) herein are not obtained on or before the Closing Date;
 - (ii) by written notice from the Lenders to the Shareholder, if the parties have not settled and entered into the Definitive Agreements on or before the Closing Date; or
 - (iii) by written notice from the Shareholder to the Lenders at any time prior to the Closing Date.
- (b) The termination of this Letter of Intent will not affect the liability of a party for breach of any of the Binding Provisions before the termination, or the survival of the Surviving Binding Provisions. Upon termination of this Letter of Intent, the parties will have no further obligations under this Letter of Intent, except with respect to the Surviving Binding Provisions which will survive in full force and effect, unamended, and which will continue to be interpreted and enforced according to the relevant provisions under “General”, below.

**ARTICLE ELEVEN
GENERAL****Section 11.01 Interpretation**

In this Letter of Intent, words signifying the singular number include the plural and vice versa, and words signifying gender include all genders. Every use of the words “including” or “includes” in this Letter of Intent is to be construed as meaning “including, without limitation” or “includes, without limitation”, respectively.

Section 11.02 Currency

All monetary amounts in this Letter of Intent, unless otherwise specified, are stated in currency of the United States of America.

Section 11.03 Governing Law

This Letter of Intent is governed by, and is to be construed and interpreted in accordance with, the laws of the Province of Ontario and the laws of Canada applicable in that Province.

Section 11.04 Time of Essence

Time is of the essence in all respects of this Letter of Intent.

Section 11.05 Severability

Each provision of this Letter of Intent is distinct and severable. If any provision of this Letter of Intent, in whole or in part, is or becomes illegal, invalid, void, voidable, or unenforceable in any jurisdiction by any court of competent jurisdiction, the illegality, invalidity or unenforceability of that provision, in whole or in part, will not affect:

- (a) the legality, validity or enforceability of the remaining provisions of this Letter of Intent, in whole or in part; or
- (b) the legality, validity or enforceability of that provision, in whole or in part, in any other jurisdiction.

Section 11.06 Amendment and Waiver

No amendment, discharge, modification, restatement, supplement, termination or waiver of this Letter of Intent or any provision of this Letter of Intent is binding unless it is in writing and executed by each Party. No waiver of, failure to exercise or delay in exercising, any provision of this Letter of Intent constitutes a waiver of any other provision (whether or not similar) nor does any waiver constitute a continuing waiver unless otherwise expressly provided.

Section 11.07 Counterparts

This Letter of Intent may be executed and delivered by the parties in one or more counterparts, each of which will be an original, and each of which may be delivered by facsimile, e-mail or other functionally equivalent electronic means of transmission, and those counterparts will together constitute one and the same instrument.

THE REMAINDER OF THIS PAGE IS INTENTIONALLY LEFT BLANK

To confirm this Letter of Intent, please sign where indicated below and return it to the Lenders before 5 p.m. on May 27, 2015, or at that time the Proposed Transactions set out above will expire automatically.

Yours very truly,

BANK OF MONTREAL

HSBC BANK CANADA

NATIONAL BANK OF CANADA

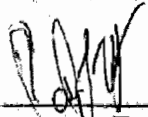
Per: 
Name: **Paul Findlay**
Office: **Senior Manager**

Per: _____
Name: _____
Office: _____

Per: _____
Name: _____
Office: _____

This Letter of Intent reflects accurately the parties' understanding with respect to the matters set out above.

Confirmed this 22nd day of May, 2015.

AMIR TUKULJ

RUSSEL ORELOWITZ

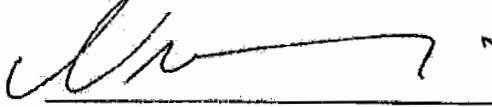



WITNESS:

WITNESS:

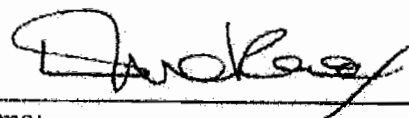
Name: _____

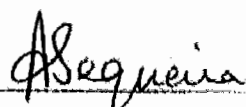
Name: _____

To confirm this Letter of Intent, please sign where indicated below and return it to the Lenders before 5 p.m. on May 27, 2015, or at that time the Proposed Transactions set out above will expire automatically.

Yours very truly,

BANK OF MONTREAL

HSBC BANK CANADA

NATIONAL BANK OF CANADA

Per: _____
Name:
Office:

Per: 
Name: **J.S. BRYDON**
Office: **Assistant Vice President**

Per: _____
Name:
Office:

*** **Cheryl Lee**
Senior Manager

This Letter of Intent reflects accurately the parties' understanding with respect to the matters set out above.

Confirmed this 22nd day of May, 2015.

AMIR TUKULJ

RUSSEL ORELOWITZ

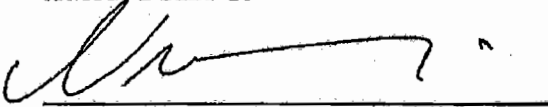



WITNESS:

WITNESS:

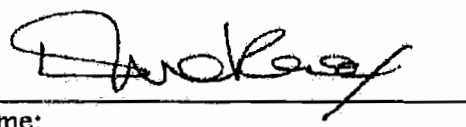
Name: _____

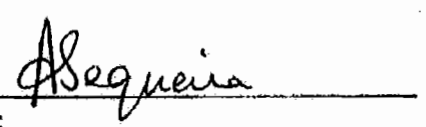
Name: _____

To confirm this Letter of Intent, please sign where indicated below and return it to the Lenders before 5 p.m. on May 27, 2015, or at that time the Proposed Transactions set out above will expire automatically.

Yours very truly,

BANK OF MONTREAL

HSBC BANK CANADA

NATIONAL BANK OF CANADA

Per: _____
Name:
Office:

Per: _____
Name:
Office:

Per: 
Name: **Jean Gosselin**
Office: **Directeur principal**

This Letter of Intent reflects accurately the parties' understanding with respect to the matters set out above.

Confirmed this 22nd day of May, 2015.

AMIR TUKULJ

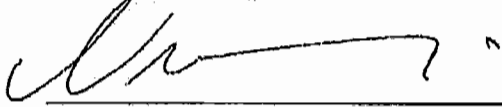

RUSSEL ORELOWITZ



WITNESS:

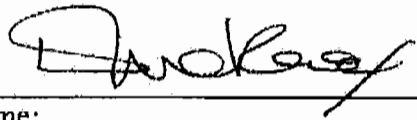

Name: _____

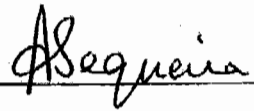
WITNESS:

Name: _____

TAB H

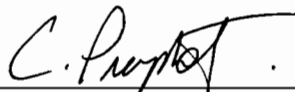
THIS IS EXHIBIT "H"
TO THE AFFIDAVIT OF PAUL FINDLAY
SWORN BEFORE ME THIS 16TH DAY
OF OCTOBER, 2015.



A Commissioner for Taking Affidavits

Clifton P. Prophet

*EXECUTION COPY***OFFER TO PURCHASE****BETWEEN**

**RICHTER ADVISORY GROUP INC., SOLELY IN ITS CAPACITY AS COURT
APPOINTED RECEIVER OF THANE INTERNATIONAL, INC., THANE DIRECT,
INC., THANE DIRECT CANADA INC., THANE DIRECT COMPANY, WEST COAST
DIRECT MARKETING, INC. AND TDG, INC. AND THANE DIRECT MARKETING
INC.
as Seller**

– and –

**9472541 CANADA INC., 9472550 CANADA INC., 635427, INC. AND 652134 LIMITED
as Buyers**

OCTOBER 16, 2015

OFFER TO PURCHASE

THIS AGREEMENT dated as of October 16, 2015

B E T W E E N :

RICHTER ADVISORY GROUP INC., solely in its capacity as court appointed receiver of **THANE INTERNATIONAL, INC., THANE DIRECT, INC., THANE DIRECT CANADA INC., THANE DIRECT COMPANY, WEST COAST DIRECT MARKETING, INC., TDG, INC. AND THANE DIRECT MARKETING INC.** and not in its personal capacity

(the “**Seller**”)

- and -

9472541 CANADA INC., a corporation existing under the laws of Canada

(the “**Buyer Holdco**”)

- and –

9472550 CANADA INC., a corporation existing under the laws of Canada

(the “**Buyer Canada Opco**”)

- and –

635427, INC., a corporation existing under the laws of Delaware

(the “**Buyer U.S. Opco**”)

- and –

652134 LIMITED, a corporation existing under the laws of England

(the “**Buyer IP Co**”)

CONTEXT:

The Seller wishes to sell and the Buyers hereby offer to purchase the Assets (as defined below) upon and subject to the terms and conditions of this Agreement.

THEREFORE, the Parties agree as follows:

ARTICLE 1 INTERPRETATION

1.1 Definitions

In this Agreement the following terms have the following meanings:

- 1.1.1 **“Accounts Receivable”** means all accounts receivable, account and monetary obligations owed or to become due and owing to the Debtors, any causes of actions, proceedings and credits in connection therewith, outstanding as of the closing date or thereafter, including tax instalments paid by the Debtors and the right to receive any refund of taxes (including, without limitation, income, goods and services, value added, sales, license, payroll, duties, withholding, social security (or similar), use, transfer, levies, stamp, governmental charges or assessments) paid by, received by or to be received by any of the Debtors.
- 1.1.2 **“Accrued Payroll”** means payroll which has been earned by the Assumed Employees as at the Closing Date but which has not been paid.
- 1.1.3 **“Agreement”** means this offer to purchase which, following the full execution and delivery hereof will become a fully enforceable agreement, including all Schedules and Exhibits, as it may be supplemented, amended, restated or replaced from time to time by written agreement between the Parties.
- 1.1.4 **“Applicable Law”** means, at any time, with respect to any Person, property, transaction or event, all applicable domestic or foreign laws (including common and civil law), statutes, regulations, treaties, judgments and decrees and (whether or not having the force of law) all applicable official directives, rules, consents, approvals, by-laws, permits, authorizations, guidelines, order and policies of any Governmental Authority having authority over that Person, property, transaction or event.
- 1.1.5 **“Appointment Order”** is defined in Section 4.3.1.
- 1.1.6 **“Approval and Vesting Order”** is defined in Section 4.3.2.
- 1.1.7 **“Assets”** means the right, title and interest of the Debtors in and to all property and assets of the Debtors, including Contracts, Intellectual Property, Accounts Receivable and Shares, but excluding the Excluded Assets.
- 1.1.8 **“Assumed Employee Accruals”** means all wages, statutory deductions, remittances, assessments, bonuses, vacation pay, sick leave credits, severance pay, termination pay, amounts paid in lieu of notice, and any other remuneration, benefits and deductions for all the Assumed Employees, including pension plan contributions and any other amounts required to be paid in respect of pension plans in which the Employees participate, that relate to a period prior to the Closing Date.

- 1.1.9 “**Assumed Employees**” means the Employees who are hired by the Buyers on or immediately after Closing, being all or substantially all of the Employees.
- 1.1.10 “**Assumed Obligations**” means all obligations and liabilities of the Debtors other than the Excluded Obligations.
- 1.1.11 “**Bankruptcy Code**” means the U.S. Bankruptcy Code.
- 1.1.12 “**Benefit Plans**” means any of the following (whether written, unwritten or terminated):
- 1.1.12.1 any employee compensation and welfare benefit plan, including but not limited to, any compensation plan, bonus plan, vacation benefits, medical plan, life insurance plan, short term or long term disability plan, vision plan, drug plan, sick leave benefits and dental plan; and
 - 1.1.12.2 any employee pension plan, including, but not limited to any supplemental or excess pension plan, any deferred compensation plan, any group registered retirement savings plan, any registered pension plan or any other arrangement under which employees are provided with retirement income; in each case, provided, sponsored, administered or contributed to by any of the Debtors in relation to the Assumed Employees.
- 1.1.13 “**Bill of Sale and Assignment**” means a bill of sale and assignment substantially in the form attached as Exhibit A.
- 1.1.14 “**Business**” means the business of the Thane Group, being the business of operating a global, multinational and direct-response enterprise with a focus on the sale of unique consumer products using developed promotional programs with product development (in-house and through third parties), manufacturing (primarily through third parties) and distribution (in-house and through third parties) to consumers locally and globally.
- 1.1.15 “**Business Day**” means any day excluding a Saturday, Sunday or statutory holiday in the Province of Ontario, and also excluding any day on which the principal chartered banks located in the City of Toronto are not open for business during normal banking hours.
- 1.1.16 “**Buyers**” means Buyer Holdco, Buyer Canada Opco, Buyer U.S. Opco and Buyer IP Co.
- 1.1.17 “**Buyers’ Transaction Costs**” is defined in Section 6.13.
- 1.1.18 “**Canadian Court**” means the Ontario Superior Court of Justice (Commercial List).
- 1.1.19 “**Canadian Debtors**” means Thane Direct Company, Thane Direct Canada Inc. and Thane Direct Marketing Inc.

- 1.1.20 “**Closing**” means the successful completion of the Transaction.
- 1.1.21 “**Closing Date**” means the second Business Day following the date on which the U.S. Recognition Order is granted or, on written notice by the Buyers to the Seller, the 14th calendar day following the date on which the U.S. Recognition Order is granted, or such later date as agreed by the Parties.
- 1.1.22 “**Communication**” means any notice, demand, request, consent, approval or other communication which is required or permitted by this Agreement to be given or made by a Party.
- 1.1.23 “**Confidential Information**” is defined in Section 6.4.1.
- 1.1.24 “**Contracts**” means all agreements, contracts, leases, licenses, warranties, options or other commitments, rights or entitlements to which any of the Debtors is a party, save and except for the Excluded Contracts listed on Schedule 2, as such Schedule may be revised or replaced up to five (5) Business Days prior to the Closing Date.
- 1.1.25 “**Courts**” means the Canadian Court and the U.S. Court.
- 1.1.26 “**Debtors**” means the Canadian Debtors and the U.S. Debtors.
- 1.1.27 “**Employees**” means the employees employed by the Debtors on the Closing Date (including for greater certainty those such employees who are employed by the Debtors but who are absent from work on the date hereof by reason of short or long term disability or by reason of authorized leave of absence).
- 1.1.28 “**Equipment**” means the equipment and tools of the Debtors described in Schedule 3.
- 1.1.29 “**ETA**” means the *Excise Tax Act* (Canada).
- 1.1.30 “**Excluded Assets**” is defined in Section 2.2.
- 1.1.31 “**Excluded Contracts**” is defined in Section 2.2.2
- 1.1.32 “**Excluded Obligations**” is defined in Section 2.5.
- 1.1.33 “**Governmental Authority**” means:
- 1.1.33.1 any federal, provincial, state, local, municipal, regional, territorial, aboriginal, or other government, governmental or public department, branch, ministry, or court, domestic or foreign, including any district, agency, commission, board, arbitration panel or authority and any subdivision of the foregoing exercising or entitled to exercise any administrative, executive, judicial, ministerial, prerogative, legislative, regulatory or taxing authority or power of any nature; or

- 1.1.33.2 any quasi-governmental or private body exercising any regulatory, expropriation or taxing authority under or for the account of any of the foregoing.
- 1.1.34 “**Intellectual Property**” means the Trademarks and all applications and registrations for the copyrights, patents, patent applications, industrial designs, engineering drawings and tooling designs of the Debtors, whether registered or unregistered (and all applications therefor), including those listed in Schedule 33 and those described in the Intellectual Property Assignment Agreement.
- 1.1.35 “**Intellectual Property Assignment Agreement**” means the assignment agreement(s) to be entered into between the Seller and Buyer IP Co with respect to the assignment of Seller’s rights in the Intellectual Property, substantially in the form attached as Exhibit B.
- 1.1.36 “**Intellectual Property License Agreements**” means the agreements to be entered into between Buyer IP Co and each of Thane Direct Company and Thane Direct Canada Inc., pursuant to which Buyer IP Co will license to each of Thane Direct Company and Thane Direct Canada Inc. the rights to use certain Intellectual Property, substantially in the form attached as Exhibit C.
- 1.1.37 “**ITA**” means the *Income Tax Act* (Canada).
- 1.1.38 “**Leased Premises**” means the leased building located at the following locations:
- 1.1.38.1 5255 Orbitor Drive, Suite 501, Mississauga, ON, L4W 5M6
- 1.1.38.2 4450 Belden Village Street, #304, Canton, OH 44718
- 1.1.38.3 2321 Rosecrans Avenue, Suite 4210, El Segundo, CA 90245-0916
- 1.1.39 “**Parties**” means the Seller and the Buyers, and “**Party**” means either one of them.
- 1.1.40 “**Person**” means an individual, body corporate, sole proprietorship, partnership or trust or unincorporated association, unincorporated syndicate, unincorporated organization, or another entity, and a natural person, acting in his or her individual capacity or in his or her capacity as executor, trustee, administrator or legal representative, and any Governmental Authority.
- 1.1.41 “**Personal Information**” is defined in Section 6.4.1.
- 1.1.42 “**Purchase Price**” means the aggregate of USD\$50,000,000, plus the Buyers’ Transaction Costs plus the amount of the Assumed Obligations.
- 1.1.43 “**Senior Lenders**” is defined in Section 6.3.
- 1.1.44 “**Shares**” means all of the issued and outstanding shares owned by the Debtors of the following entities:

- 1.1.44.1 Media Latino, Inc.;
 - 1.1.44.2 Thane U.S.A., Inc.;
 - 1.1.44.3 Grupo Mejor Compra SAPI de CV;
 - 1.1.44.4 Danoz Direct Pty. Ltd.;
 - 1.1.44.5 TVNS Scandinavia AB; and
 - 1.1.44.6 Thane Direct UK Ltd.
- 1.1.45 **“Thane Group”** means the following entities: the Debtors, Grupo Mejor Compra SAPI de CV, Operadora Ainoa SAPI de CV Servicios Profesionales de TMK SAPI de CV, Danoz Direct Pty. Ltd., TVNS Scandinavia AB, Thane Direct UK Ltd., Thane U.S.A. Inc. and Media Latino, Inc.
- 1.1.46 **“Time of Closing”** means 2 p.m. (EST) on the Closing Date or such other time on the Closing Date as the Parties may mutually agree.
- 1.1.47 **“Trade-marks”** means the unregistered and registered (and applications therefor) trade-marks of the Debtors, including those described in the Intellectual Property Assignment Agreements and includes all rights to any internet or world wide web domain names, sites and rights described therein.
- 1.1.48 **“Transaction”** means the transaction of purchase and sale contemplated by this Agreement.
- 1.1.49 **“U.S. Court”** means the United States Bankruptcy Court for the District of Delaware or any other court with jurisdiction over the U.S. Recognition Order.
- 1.1.50 **“U.S. Debtors”** means Thane International, Inc., West Coast Direct Marketing, Inc., TDG, Inc. and Thane Direct, Inc.
- 1.1.51 **“U.S. Recognition Order”** is defined in Section 4.3.3.

1.2 **Certain Rules of Interpretation**

- 1.2.1 In this Agreement, words signifying the singular number include the plural and vice versa, and words signifying gender include all genders. Every use of the word “including” in this Agreement is to be construed as meaning “including, without limitation”.
- 1.2.2 The division of this Agreement into Articles and Sections, the insertion of headings and the provision of a table of contents are for convenience of reference only and do not affect the construction or interpretation of this Agreement.

- 1.2.3 References in this Agreement to an Article, Section, Schedule or Exhibit are to be construed as references to an Article, Section, Schedule or Exhibit of or to this Agreement unless the Context requires otherwise.
- 1.2.4 Unless otherwise specified in this Agreement, time periods within which or following which any payment is to be made or act is to be done will be calculated by excluding the day on which the period commences and including the day on which the period ends. If the last day of a time period is not a Business Day, the time period will end on the next Business Day.
- 1.2.5 Unless otherwise specified, any reference in this Agreement to any statute includes all regulations made under or in connection with that statute, and is to be construed as a reference to that statute as amended, supplemented or replaced.

1.3 Governing Law

This Agreement is governed by, and is to be construed and interpreted in accordance with, the laws of the Province of Ontario and the laws of Canada applicable in that Province.

1.4 Entire Agreement

This Agreement and any other agreement or agreements and other documents to be delivered under this Agreement, constitutes the entire agreement between the Parties pertaining to the subject matter of this Agreement and supersedes all prior agreements, understandings, negotiations and discussions, whether oral or written, of the Parties and there are no representations, warranties or other agreements between the Parties in connection with the subject matter of this Agreement except as specifically set out in this Agreement or in any of the other agreements and documents delivered under this Agreement.

1.5 Time of Day

Unless otherwise specified, references to time of day or date mean the local time or date in the City of Toronto, Province of Ontario.

1.6 Business Day

Whenever any payment to be made or action to be taken under this Agreement is required to be made or taken on a day other than a Business Day, the payment is to be made or action taken on the next Business Day following.

1.7 Currency

Unless otherwise specified, all monetary amounts set out in this Agreement are in the currency of the United States of America.

1.8 Schedules and Exhibits

The following is a list of Schedules and Exhibits. Any Schedule may be revised or replaced by the Buyer at its option at any time up to five (5) Business Days prior to the Closing Date.

Schedule	Subject Matter	Section Reference
Schedule 1	Description of Assets Being Conveyed	2.1
Schedule 2	Excluded Contracts	2.2.2
Schedule 33	Intellectual Property	1.1.34
Exhibit	Subject Matter	Section Reference
Exhibit A	Form of Bill of Sale and Assignment	1.1.13
Exhibit B	Form of Intellectual Property Assignment Agreement	1.1.35
Error! Reference source not found.C	Form of Intellectual Property License Agreement	1.1.36
Exhibit E-1	Form of Appointment Order	4.3
Exhibit E-2	Form of Canadian Approval and Vesting Order	4.3
Exhibit E-3	Form of U.S. Recognition Order	4.3
Exhibit E-4	Form of U.S. Final Sale Approval Order	4.3

ARTICLE 2 SALE AND PURCHASE AND ASSIGNMENT

2.1 Sale and Purchase of Assets

Subject to the terms and conditions of this Agreement, the Seller will sell and transfer to the Buyers and the Buyers will purchase the Assets and assume the Assumed Obligations on the Closing Date. The Buyers acknowledge that they are not purchasing any other property or assets of the Debtors other than the Assets. Schedule 1 sets out a description of (1) the Assets that will be bought by each Buyer, and (2) the identity of the Debtor that owns each of the Assets. On

Closing, and having regard to the sequencing contemplated in Section 5.2, the Assets will be conveyed among the Parties in the manner contemplated in Schedule 1.

2.2 Excluded Assets

Notwithstanding anything in this Agreement to the contrary, the Debtors shall retain all right, title and interest in and to the following assets, and the Buyers will not in any way be construed to have purchased or acquired (or be obligated to purchase or acquire) any interest whatsoever in any of the following assets (collectively the “**Excluded Assets**”):

- 2.2.1 all of the issued and outstanding shares of the following entities:
 - 2.2.1.1 Thane International, Inc.
 - 2.2.1.2 West Coast Direct Marketing, Inc.
 - 2.2.1.3 TDG, Inc.
 - 2.2.1.4 Media Latino Source, Inc.;
 - 2.2.1.5 Thane Direct, Inc.;
 - 2.2.1.6 Thane Direct Marketing Inc.;
 - 2.2.1.7 Thane Direct Canada Inc.;
 - 2.2.1.8 Thane Dutch Holdings Coop;
 - 2.2.1.9 Thane Deutschland GmbH;
 - 2.2.1.10 Thane Direct Company; and
 - 2.2.1.11 TrendPro TV GmbH; and
- 2.2.2 all of the Contracts designated in Schedule 2 (the “**Excluded Contracts**”) which are not being assumed by the Buyers pursuant to the transactions contemplated in this Agreement, so long as any such Contract is designated as such in Schedule 2 prior to Closing.

2.3 Assignment and Assumption of Contracts

Subject to the conditions and terms of this Agreement, the Seller will assign to the Buyers all of the Debtors’ rights, benefits and interests in and to the Contracts and the Buyers will assume the Assumed Obligations. More particularly, each Buyer will assume the obligations relating to those Contracts being purchased by it in accordance with Schedule 1 and Schedule 2. This Agreement and any document delivered under this Agreement will not constitute an assignment or an attempted assignment of any Contract contemplated to be assigned to a Buyer under this Agreement which is not assignable without the consent of a third party if that consent has not

been obtained and that assignment or attempted assignment would constitute a breach of such Contract. At the option of the Seller, any such assignment may be made in the name of and on behalf of any of the Debtors.

2.4 “As is, Where is”

Each Buyer acknowledges that the Seller is selling the Assets on an “as is, where is” basis as they exist on the Closing Date, and that once the Assets are in the possession of the Buyers, the Seller will have no further liability to the Buyers. Each Buyer further acknowledges that it has entered into this Agreement on the basis that the Seller does not guarantee title to the Assets and that such Buyer has conducted any inspections of the condition of and title to the Assets that it deemed appropriate, and has satisfied itself with regard to these matters. No representation, warranty or condition is expressed or can be implied as to title, encumbrances, description, fitness for purpose, merchantability, condition, quantity or quality, assignability or in respect of any other matter or thing concerning the Assets or the right of the Seller to sell them, save as expressly represented or warranted in this Agreement. Without limiting the generality of the foregoing, any and all conditions, warranties or representations expressed or implied pursuant to the *Sale of Goods Act* (Ontario) or similar legislation do not apply to the Transaction and have been waived by the Buyers. The description of the Assets contained in the Schedules is for purposes of identification only. No representation, warranty or condition has or will be given by the Seller concerning the completeness or accuracy of those descriptions.

2.5 Excluded Obligations

The Buyers will not assume and will not be liable for any of the following liabilities or obligations of the Debtors (collectively, the “**Excluded Obligations**”):

- 2.5.1 Any liabilities or obligations of the Debtors or the Seller to any bank or other financial institution by way of loan, credit facility, guarantee, or otherwise;
- 2.5.2 Any liabilities or obligations of the Debtors for any claims for any reason arising or occurring on or before the Closing Date, including for negligence, injury, accident or other alleged damage causing event with respect to the operations of the Debtors on or prior to the Closing Date (“**Pre-Closing Claims**”) or relating to products or services manufactured or sold or services performed by the Debtors on or before the Closing Date that provide the basis for claim, including warranty claims, whether demands for or proceedings upon such Pre-Closing Claims are commenced before or after the Closing Date;
- 2.5.3 Any liabilities of the Debtors for any claims, demands, actions, or proceedings relating to the Excluded Assets;
- 2.5.4 Any liabilities of the Debtors for any breach by any of the Debtors of any laws, including employment and environmental laws relating to the operation of the Business or use of the Purchased Assets on or prior to the Closing Date; and

2.5.5 Any liabilities of the Debtors for any income tax, or for any other taxes, duties or similar charges (including penalties, fines and interest).

2.6 Payment of the Purchase Price

On or prior to the Time of Closing, the Buyers will pay the Purchase Price to the Seller, or as the Seller otherwise directs, as follows:

2.6.1 the sum of USD\$50,000,000 will be paid to the Seller by Buyer Holdco, Buyer Canada Opco, Buyer U.S. Opco and Buyer IP in accordance with the allocation made pursuant to Section 2.7.

2.6.2 The Buyers will pay the amount of the Buyers Transactions Costs; and

2.6.3 the Buyers will assume the Assumed Obligations.

2.7 Allocation of Purchase Price

The Seller and the Buyers shall negotiate in good faith to agree on an allocation of the Purchase Price to the Assets no later than the third (3rd) Business Day before Closing. The Purchase Price shall be allocated to the Assets in accordance with such agreed allocation.

2.8 Taxes

2.8.1 The Buyers will pay upon Closing, in addition to the Purchase Price, all applicable taxes payable in connection with the sale and purchase of the Assets under this Agreement, including all federal, provincial and state taxes, exigible in connection with the purchase and sale of the Assets, including subject to Section 2.8.3, harmonized sales tax, or if applicable, goods and services tax, and any other applicable sales tax and any transfer, documentary, use, stamp, registration and similar taxes and charges (including penalties and interest), but for greater certainty, excluding all income, profits, revenue or other similar taxes which may be incurred by any Debtors or other Person party to the transactions contemplated by this Agreement. Alternatively, where applicable, the Buyers will have the option to furnish the Seller with appropriate exemption certificates.

2.8.2 The Buyers agree to indemnify and save the Seller harmless from and against all claims and demands for payment of all applicable taxes payable by the Buyers in connection with the purchase and sale of the Assets under this Agreement, including penalties and interest and any liability or costs incurred as a result of any failure to pay those taxes when due.

2.8.3 The Parties will complete and sign on or before the Closing Date, or as soon as practicable thereafter, as Buyer Holdco and/or Buyer Canada Opco may request, joint elections containing prescribed information under section 167(1) of the ETA to permit the purchase and sale of the Assets without incurring goods and services taxes or harmonized sales taxes. Each Buyer, as applicable, will duly file the elections with

the appropriate Governmental Authorities and shall file those elections in compliance with the requirements of and within the time permitted under the ETA.

- 2.8.4 The Seller and Buyer Canada Opco will execute and file, within the prescribed time limits, joint elections with respect to any Accounts Receivable forming part of the Assets, under section 22 of the ITA and any corresponding provisions of any other applicable laws relating to taxes, and will designate in those joint elections the portion of the Purchase Price allocated to the Accounts Receivable as the consideration paid by the Buyer Canada Opco to the Seller for the Accounts Receivable for the purposes of the elections.

2.9 Assumed Employees

- 2.9.1 On or before the Closing Date the Buyers will offer, conditional on the completion of the Closing, employment to each of the Assumed Employees at the same rate of wages and benefits then provided by the Debtors, and upon other terms and conditions that are the same as those of his or her current employment with the Debtors, including fixed termination dates included in written agreements with the Debtors, as applicable, which employment will commence as at the Closing Date. The Buyers in making the offers of employment will recognize the seniority and years of service of such Assumed Employees.

- 2.9.2 Each Buyer acknowledges and agrees that:

2.9.2.1 the Seller makes no representation or warranty that any Assumed Employee will accept employment with the Buyers; and

2.9.2.2 the acceptance by the Assumed Employees of offers of employment with a Buyer will not constitute a condition to the Buyer's obligation to complete the Transaction.

- 2.9.3 Until the Closing Date, subject to the Buyers' assumption of the Accrued Payroll and Assumed Employee Accruals, the Debtors will be responsible for payment of all wages, statutory deductions, remittances, assessments, bonuses, vacation pay, sick leave, severance pay, termination pay, amounts paid in lieu of notice, and any other remuneration, benefits and deductions for all the Employees, that become due and payable prior to the Closing Date, together with any obligation to pay all severance or termination pay and other payments owing to Employees who are not Assumed Employees that arise by operation of Applicable Law on the Closing Date. On the Closing Date, the Buyers will assume the Accrued Payroll and the Assumed Employee Accruals.

- 2.9.4 Effective as of the Closing Date, the Buyers will, going forward, assume the obligations of the Debtors under the Benefit Plans and all of Debtors' obligations, liabilities and responsibilities as sponsor(s) under the Benefit Plans relating to the Assumed Employees. During the 90 day period following the Closing Date, the Seller will cooperate with the Buyers and provide the Buyers with any assistance that it may

reasonably require in order to give effect to its obligations pursuant to this Section; provided that the Seller will be under no obligation to obtain any consents or to expend any amount or incur any liability providing that assistance or in seeking any consents.

- 2.9.5 Except to the extent otherwise imposed by Applicable Law, the Debtors will be responsible for all unpaid workers' compensation amounts, including payroll premiums, non-compliance charges, experience rating surcharges, work week surcharges, levies and penalties relating to the Employees arising out of events occurring on or prior to the Closing Date and which are due and payable prior to the Closing Date, and the Buyer will be responsible for all such amounts arising out of events occurring on or after the Closing Date and relating to the Assumed Employees.

ARTICLE 3 REPRESENTATIONS AND WARRANTIES

3.1 Buyers' Representations

Each Buyer represents and warrants to the Seller that:

- 3.1.1 it is a corporation duly incorporated, organized and subsisting under the laws of the jurisdiction of its formation;
- 3.1.2 it has all necessary corporate power, authority and capacity to enter into this Agreement and to perform its obligations under this Agreement and the execution and delivery of this Agreement and the consummation of the Transaction have been duly authorized by all necessary corporate action on the part of the Buyer;
- 3.1.3 it is not a Party to, bound or affected by or subject to any indenture, agreement, instrument, charter or by-law provision, order, judgment or decree which would be violated, contravened or breached by the execution and delivery by it of this Agreement or the performance by it of any of the terms contained in this Agreement;
- 3.1.4 to the best of the Buyer's knowledge, no actions or proceedings are pending or have been threatened to restrain or prohibit the completion of the Transaction;
- 3.1.5 this Agreement and each of the other documents contemplated under this Agreement to which the Buyer is or will be a Party have been or will be, as at the Time of Closing, duly and validly executed and delivered by the Buyer and constitutes or will, as at the Time of Closing, constitute legal, valid and binding obligations of the Buyer, enforceable in accordance with its terms;
- 3.1.6 each of Buyer Holdco, Buyer Canada Opco, Buyer US Opco and Buyer IP Co is not a non-Canadian person as defined in the *Investment Canada Act*;
- 3.1.7 each of Buyer Holdco and Buyer Canada Opco will be registered under Part IX of the ETA on or before the Time of Closing and Buyer IP Co is a non-resident person, as

defined in the ETA, and is not registered under Subdivision d of Division V of Part IX of the ETA; and

- 3.1.8 all of the issued and outstanding shares in the capital of each of Buyer Canada Opco and Buyer U.S. Opco are legally and beneficially owned by Buyer Holdco.

3.2 Seller's Representations

The Seller represents and warrants to the Buyers that:

- 3.2.1 upon the granting of the Appointment Order, the Approval and Vesting Order and the U.S. Recognition Order, the Seller has the right to enter into this Agreement and to complete the Transaction;
- 3.2.2 the Seller is not a non-resident of Canada within the meaning of that term as used in the *Income Tax Act* (Canada);
- 3.2.3 the Seller has done no act to encumber the Assets;
- 3.2.4 the Seller has not previously sold or done any act to encumber the Assets; and
- 3.2.5 to the best of the Seller's knowledge, no actions or proceedings are pending and none have been threatened to restrain or prohibit the completion of the Transaction.

ARTICLE 4 CONDITIONS

4.1 Conditions of the Buyers

The obligation of the Buyers to complete the Transaction is subject to the following conditions being fulfilled or performed at or prior to the Time of Closing:

- 4.1.1 all representations and warranties of the Seller contained in this Agreement will be true as of the Closing Date with the same effect as though made on and as of that date;
- 4.1.2 no action or proceedings will be pending or threatened to restrain or prohibit the completion of the Transaction contemplated by this Agreement;
- 4.1.3 the Seller will have performed each of its obligations under this Agreement to the extent required to be performed on or before the Closing Date; and
- 4.1.4 no material loss or damage to the Assets will have occurred on or before the Closing Date.

The foregoing conditions are for the exclusive benefit of the Buyers. Any condition may be waived by the Buyers in whole or in part. Any such waiver will be binding on the Buyers only if made in writing.

4.2 Conditions of the Seller

The obligation of the Seller to complete the Transaction is subject to the following conditions being fulfilled or performed at or prior to the Time of Closing:

- 4.2.1 all representations and warranties of the Buyers contained in this Agreement will be true as of the Closing Date with the same effect as though made on and as of that date;
- 4.2.2 no action or proceedings will be pending or threatened to restrain or prohibit the completion of the Transaction contemplated by this Agreement;
- 4.2.3 the Buyers will have performed each of their obligations under this Agreement to the extent required to be performed on or before the Closing Date; and
- 4.2.4 no material loss or damage to the Assets will have occurred on or before the Closing Date.

The foregoing conditions are for the exclusive benefit of the Seller. Any condition may be waived by the Seller in whole or in part. Any such waiver will be binding on the Seller only if made in writing.

4.3 Conditions of the Seller and Buyers

The obligations of the Seller and the Buyers to complete the Transaction are subject to the following conditions being fulfilled or performed at or prior to the Time of Closing:

- 4.3.1 an order of the Canadian Court on or before October 23, 2015:
 - 4.3.1.1 appointing Richter Advisory Group Inc. as receiver of the Debtors pursuant to Section 243 of the *Bankruptcy and Insolvency Act* (Canada) and Section 101 of the *Courts of Justice Act* (Ontario), solely for the purpose of conveying the Assets; and
 - 4.3.1.2 appointing the Receiver as the foreign representative of the Debtors and authorizing it to apply on their behalf to the U.S. Court for the U.S. Recognition Order,

that order to be substantially in the form of the order attached as Exhibit E-1 (the “**Appointment Order**”);
- 4.3.2 an order will have been made by the Canadian Court on or before October 23 2015 approving this Agreement and the Transaction, exempting the transaction from the

- Bulk Sales Act* (Ontario), and vesting in the Buyers all the right, title and interest in and to the Assets, as more particularly described in Schedule 1, free and clear of all liens, security interests and other encumbrances, that order to be substantially in the form of the order attached as Exhibit E-2 (the “**Approval and Vesting Order**”);
- 4.3.3 one or more orders will have been made by the U.S. Court on or before December 15, 2015 under Chapter 15 of the Bankruptcy Code recognizing and giving effect to both the Appointment Order and the Approval and Vesting Order (as it relates to the US Debtor Assets), that order to be substantially in the form of the order attached as Exhibit E-3 (the “**U.S. Recognition Order**”);
- 4.3.4 each of the Appointment Order, the Approval and Vesting Order and the U.S. Recognition Order will not have been stayed, varied or vacated and no order will have been issued and no action or proceeding will be pending to restrain or prohibit the completion of the Transaction;
- 4.3.5 all consents, approvals, orders and authorizations of any Person or Governmental Authority (or registrations, declarations, filings or recordings with any of them), required for the Closing (other than routine post-closing notifications or filings) shall have been obtained or made, including:
- 4.3.5.1 all requisite approvals and consents required from the minority 20% shareholder of Grupo Mejor Compra SAPI de CV to the sale of shares of Grupo Mejor Compra SAPI de CV contemplated by this Agreement; and
- 4.3.5.2 the approval and consent of the Superintendent of Financial Institutions (appointed pursuant to the *Office of the Superintendent of Financial Institutions Act* (Canada)) to the financial institutions holding equity directly or indirectly in Buyer Holdco for a period of not less than eight (8) years from Closing, as such consent is provided for in subsection 472(4) and 934(3) of the *Bank Act* (Canada);
- 4.3.6 the Buyers will have procured an executed commitment letter with respect to the financing of the Transaction upon terms and conditions satisfactory to the Buyers, and all documentation, including loan agreements, security agreements, charges, pledges, guarantees and otherwise shall have been settled and agreed to by the Buyers and its lenders so that they may complete the Transaction;
- 4.3.7 a unanimous shareholders’ agreement for Buyer Holdco, in form and substance satisfactory to Buyer Holdco, shall be fully executed and delivered by all of the parties thereto; and
- 4.3.8 all documents, registrations or filings required to effect the change of name of any of the entities listed in Section 2.2.1 containing “Thane” in their names to delete “Thane” from their corporate and business names shall have been executed and delivered to the Buyers and all applicable registrations or filings shall have been made.

The Parties hereto acknowledge that the foregoing conditions are for the mutual benefit of the Seller and the Buyers.

4.4 Non-Satisfaction of Conditions

If any condition set out in this Article is not satisfied or performed prior to the time specified therefor, a Party for whose benefit the condition is inserted may in writing:

- 4.4.1 waive compliance with the condition in whole or in part in its sole discretion by written notice to the other Party and without prejudice to any of its rights of termination in the event of non-fulfilment of any other condition in whole or in part; or
- 4.4.2 elect on written notice to the other Party to terminate this Agreement before Closing.

ARTICLE 5 CLOSING

5.1 Closing

The completion of the Transaction will take place at the Toronto offices of Gowling Lafleur Henderson LLP, on the Closing Date at the Time of Closing or as otherwise determined by mutual agreement of the Parties in writing.

5.2 Transaction Sequence

On the terms and subject to the conditions set forth in this Agreement, at the Closing, the following will occur and be deemed to occur in the following order (at fifteen minute intervals):

- 5.2.1 the purchase and sale of the Intellectual Property to Buyer IP Co pursuant to the Intellectual Property Assignment Agreement will occur;
- 5.2.2 Buyer IP Co will enter into the Intellectual Property License Agreements with each of Thane Direct Company and Thane Direct Canada Inc.; and
- 5.2.3 the purchase and sale of those Assets designated on Schedule 1 as being purchased by each of Buyer Canada Opco and Buyer U.S. Opco will occur, including for greater certainty, all of Thane Direct Company's and Thane Direct Canada Inc.'s rights under the Intellectual Property License Agreements, and the assumption by each of Buyer Canada Opco and Buyer U.S. Opco from the Seller of the Assumed Obligations will occur.

5.3 Buyers' Deliveries on Closing

At or before the Time of Closing, the Buyers will execute and deliver to the Seller the following, each of which will be in form and substance satisfactory to the Seller, acting reasonably:

- 5.3.1 payment of the Purchase Price;
- 5.3.2 the Intellectual Property Assignment Agreement;
- 5.3.3 the Intellectual Property License Agreements;
- 5.3.4 the Bill(s) of Sale and Assignment;
- 5.3.5 a certificate dated the Closing Date, confirming that all of the representations and warranties of the Buyers contained in this Agreement are true as of the Closing Date, with the same effect as though made on and as of the Closing Date;
- 5.3.6 a certificate dated the Closing Date, confirming that each of the conditions precedent in Section 4.1 and 4.3 of this Agreement have been fulfilled, performed or waived as of the Closing Date;
- 5.3.7 an assumption agreement with respect to the Assumed Obligations; and
- 5.3.8 any other documentation as is referred in this Agreement or as the Seller may reasonably require to give effect to this Agreement.

5.4 Seller's Deliveries on Closing

At or before the Time of Closing, the Seller will execute and deliver (to the extent the document listed below is to be executed by the Seller) to the Buyers the following, each of which will be in form and substance satisfactory to the Buyer, acting reasonably:

- 5.4.1 the Bill(s) of Sale and Assignment;
- 5.4.2 the Intellectual Property Assignment Agreement;
- 5.4.3 the Intellectual Property License Agreement;
- 5.4.4 a certificate dated the Closing Date confirming that all of the representations and warranties of the Seller contained in this Agreement are true as of the Closing Date, with the same effect as though made on and as of the Closing Date;
- 5.4.5 a certificate dated the Closing Date confirming that each of the conditions precedent in Sections 4.2 and 4.3 of this Agreement have been fulfilled, performed or waived as of the Closing Date;
- 5.4.6 the Appointment Order;
- 5.4.7 the Approval and Vesting Order;
- 5.4.8 the U.S. Recognition Order; and

5.4.9 any other documentation as is referred to in this Agreement or as the Buyers may reasonably request to give effect to this Agreement.

5.5 Buyers' Acknowledgement

The Buyers acknowledges that the Seller is selling the right, title and interest of the Debtors in the Assets pursuant to the Seller's powers as authorized by the Appointment Order, the Approval and Vesting Order and the U.S. Recognition Order. The Buyers agree to purchase and accept the right, title and interest of the Seller in and to the Assets pursuant to and in accordance with the terms of this Agreement and the Bill of Sale and Assignment and other assignment and assumption agreements delivered pursuant to the terms of this Agreement.

5.6 Possession of Assets

The Debtors will remain in possession of the Assets until the Time of Closing. On Closing, and having regard to the sequencing contemplated by Section 5.2, the Buyers will take possession of the Assets where situate at the Time of Closing. The Buyers acknowledge that the Seller has no obligation to deliver physical possession of the Assets to the Buyers. In no event will the Assets be sold, assigned, transferred or set over to the Buyers until the Buyers have satisfied all delivery requirements outlined in Section 5.3.

5.7 Access to Assets

5.7.1 The Buyers may have reasonable access to the Assets located at the Leased Premises during normal business hours prior to the Time of Closing for the purpose of enabling the Buyers to conduct any inspections of the Assets as it deems appropriate. Those inspections will only be conducted in the presence of a representative of the Seller if so required at the discretion of the Seller.

5.7.2 The Buyers agree to indemnify and save the Seller harmless from and against all claims, demands, losses, damages, actions and costs incurred or arising from or in any way directly related to the inspection of the Assets or the attendance of the Buyers, their employees, contractors or agents at, or the removal of the Assets from, the Leased Premises.

5.8 Risk

The Assets will be and remain at the risk of the Debtors and/or Seller until Closing and at the risk of the Buyers from and after Closing. If, prior to Closing, the Assets are substantially damaged or destroyed by fire or other casualty, then, at its option, the Buyers may decline to complete the Transaction. This option will be exercised within 15 days after notification to the Buyers by the Seller of the occurrence of damage or destruction (or prior to the Closing Date if such occurrence takes place within 15 days of the Closing Date) in which event this Agreement will be terminated automatically. If the Buyers do not exercise this option, it will complete the Transaction and will be entitled to an assignment of the proceeds of insurance referable to such damage or destruction. Where any damage or destruction is not substantial, the Buyers will

complete the Transaction and will be entitled to an assignment of the proceeds of insurance referable to such damage or destruction provided that such damage or destruction is insured or, otherwise, to an agreed abatement.

5.9 Termination

If either the Seller or the Buyers validly terminate(s) this Agreement under the provisions of Sections 4.4 or 5.8:

- 5.9.1 all the obligations of both the Seller and Buyers under this Agreement will be at an end; and
- 5.9.2 neither Party will have any right to specific performance or other remedy against, or any right to recover damages or expenses from, the other.

ARTICLE 6 GENERAL

6.1 Paramountcy

In the event of any conflict or inconsistency between the provisions of this Agreement, and any other agreement, document or instrument executed or delivered by the Seller in connection with this Transaction or this Agreement, the provisions of this Agreement will prevail to the extent of that conflict or inconsistency.

6.2 Seller's Capacity

The Buyers acknowledge that the persons signing this Agreement, and any and all documents contemplated by this Agreement or relating to the Transaction, on behalf of the Seller is acting solely in his/her capacity as an authorized signatory of the Seller, and the Seller is acting solely in its capacity as court appointed Receiver of the Debtors, and such persons and the Seller shall have no personal or corporate liability of any kind, whether in contract, in tort or otherwise.

6.3 Commission

Notwithstanding Section 6.13, the Parties agree that any fees payable to SSG Advisors, LLC ("SSG Fees") pursuant to a June 2014 engagement letter will be negotiated and paid by Bank of Montreal, HSBC Bank Canada and National Bank of Canada as senior lenders to the Debtors (collectively, the "**Senior Lenders**") and added to the existing indebtedness of the Debtors to the Senior Lenders and for greater certainty, SSG shall have no recourse to the Lenders or the Buyers for the payment of such SSG Fees.

Other than the SSG Fees, the Buyers acknowledge that there are no agent or broker fees or other commissions payable by the Seller on the Purchase Price or otherwise in connection with the Transaction, and the Buyers agree to indemnify the Seller against any claim for compensation or

commission by any third Party or agent retained by the Buyers in connection with, or in contemplation of, the Transaction.

6.4 Confidentiality

6.4.1 Except as may be required by law, the Parties will not, and will not allow any of their representatives or advisors to collect, disclose, or use, any Confidential Information (as defined below) at any time or in any manner, except for the purpose of consummating the Transaction and for the purpose of the Buyers carrying on the Business. For the purposes of this Agreement, “**Confidential Information**” means any information relating to the Transaction, including information relating to identifiable individuals (“**Personal Information**”), whether communicated in written form, orally, visually, demonstratively, technically or by any other electronic form or other media, or committed to memory, but excluding information, other than Personal Information, which:

6.4.1.1 was available to or known by the public before the date of this Agreement;

6.4.1.2 was or is obtained from a source other than the Parties or any person bound by a duty of confidentiality to the Parties; or

6.4.1.3 is or becomes available to or known by the public other than as a result of improper disclosure by the Parties or any of their representatives, advisors or lenders.

6.4.2 If the Transaction is not consummated, each of the Seller, on the one hand, and the Buyers, on the other hand, or any of their representatives, advisors or lenders, as applicable, will promptly return to the other of them any Confidential Information in its/their possession.

6.5 Time of Essence

Time is of the essence in all respects of this Agreement.

6.6 Notices

Any Communication must be in writing and either:

6.6.1 personally delivered;

6.6.2 sent by prepaid registered mail; or

6.6.3 sent by facsimile, email or functionally equivalent electronic means of communication, charges (if any) prepaid.

Any Communication must be sent to the intended recipient at its address as follows:

to the Seller at:

181 Bay Street
Suite 3320
Bay Wellington Tower
Toronto, Ontario M5J 2T3

Attention: Paul van Eyk
Tel No.: 416 488 2345
Facsimile No.: 416 488 3765
E-mail: PvanEyke@richter.ca

with a copy (which will not constitute notice) to:

Borden Ladner Gervais LLP
Scotia Plaza
40 King Street West
Toronto, Ontario M5H 3Y4

Attention: Gordon Raman
Tel No.: 416 367 6232
Facsimile No.: 416 361 7311
E-mail: graman@blg.com

to the Buyers at:

501-5255 Orbitor Dr.
Mississauga, Ontario L4W 5M6
Attention: Russel Orelowitz and Amir Tukulj
Tel No.: 905 625 3800
Facsimile No.: 905 248 3572
E-mail: russel@thanedirect.com
amir@thanedirect.com

with a copy (which will not constitute notice) to:

Aird & Berlis LLP
Brookfield Place
181 Bay street
Suite 1800, Box 754
Toronto, Ontario M5J 2T9

Attention: Stanley W.L. Freedman
Tel No.: 416-865-7762
Facsimile No.: 416-863-1515
E-mail: sfreedman@airdberlis.com

or at any other address that any Party may from time to time advise the other by Communication given in accordance with this Section 6.6. Any Communication delivered to the Party to whom it is addressed will be deemed to have been given and received on the day it is delivered at that Party's address, provided that if that day is not a Business Day then the Communication will be deemed to have been given and received on the next Business Day. Any Communication transmitted by facsimile or other form of electronic communication will be deemed to have been given and received on the day on which it was transmitted (but if the Communication is transmitted on a day which is not a Business Day or after 3:00 p.m. (local time of the recipient), the Communication will be deemed to have been received on the next Business Day).

6.7 Severability

Each provision of this Agreement is distinct and severable. If any provision of this Agreement, in whole or in part, is or becomes illegal, invalid or unenforceable in any jurisdiction by a court of competent jurisdiction, the illegality, invalidity or unenforceability of that provision will not affect:

6.7.1 the legality, validity or enforceability of the remaining provisions of this Agreement;
or

6.7.2 the legality, validity or enforceability of that provision in any other jurisdiction.

6.8 Submission to Jurisdiction

Without prejudice to the ability of any Party to enforce this Agreement in any other proper jurisdiction, each of the Parties irrevocably submits and attorns to the non-exclusive jurisdiction of the courts of the Province of Ontario to determine all issues, whether at law or in equity arising from this Agreement. To the extent permitted by applicable law, each of the Parties irrevocably waives any objection (including any claim of inconvenient forum) that it may now or hereafter have to the venue of any legal proceeding arising out of or relating to this Agreement in the courts of that Province or that the subject matter of this Agreement may not be enforced in the courts and irrevocably agrees not to seek, and waives any right to, judicial review by any court which may be called upon to enforce the judgment of the courts referred to in this Section 6.8, of the substantive merits of any such suit, action or proceeding. To the extent a Party has or hereafter may acquire any immunity from jurisdiction of any court or from any legal process (whether through service or notice, attachment prior to judgment, attachment in aid of execution, execution or otherwise) with respect to itself or its property, that Party irrevocably waives that immunity in respect of its obligations under this Agreement.

6.9 Amendment and Waiver

No supplement, modification, amendment, waiver, discharge or termination of this Agreement is binding unless it is executed in writing by the Party to be bound. No waiver of, failure to exercise or delay in exercising, any provision of this Agreement constitutes a waiver of any other provision (whether or not similar) nor does such waiver constitute a continuing waiver unless otherwise expressly provided.

6.10 Further Assurances

Each Party will, at the requesting Party's reasonable cost, execute and deliver all further agreements and documents and provide all further assurances as may be reasonably required by the other Party to give effect to this Agreement and, without limiting the generality of the foregoing, will do or cause to be done all acts and things, execute and deliver or cause to be executed and delivered all agreements and documents and provide all assurances, undertakings and information as may be required from time to time by all regulatory or governmental bodies.

6.11 Assignment and Enurement

Neither this Agreement nor any right or obligation under this Agreement may be assigned by either Party without the prior consent of the other Party. This Agreement enures to the benefit of and is binding upon the Parties and their respective successors and permitted assigns.

6.12 Counterparts

This Agreement may be executed and delivered by the Parties in one or more counterparts, each of which when so executed and delivered will be an original and such counterparts will together constitute one and the same instrument. To evidence the fact that a Party has executed this Agreement, such Party may send a copy of its executed counterpart to the other Party by Electronic Transmission and, if sent by email, in Portable Document File (PDF) format. That Party will be deemed to have executed this Agreement on the date it sent such Electronic Transmission.

6.13 Costs and Expenses

Except as set out in Section 6.3 or as otherwise specified in this Agreement, all outstanding and unpaid costs and expenses (including the fees and disbursements of accountants, legal counsel and other professional advisers) incurred in connection with this Agreement and the completion of the Transaction up to and including the Closing Date (collectively, "**Transaction Costs**") are to be paid as follows:

- 6.13.1 The Buyers shall pay 65% of the aggregate amount of the Transaction Costs (the "**Buyers' Transaction Costs**"), which amount shall be included in the Purchase Price paid by the Buyers; and
- 6.13.2 The Senior Lenders shall pay 35% of the aggregate amount of the Transaction Costs, which amount shall be added to the existing indebtedness of the Debtors.

6.14 *No Contra Proferentem*

This Agreement has been reviewed by each Party's professional advisors, and revised during the course of negotiations between the Parties. Each Party acknowledges that this Agreement is the product of their joint efforts, that it expresses their agreement, and that, if there is any ambiguity in any of its provisions, that provision should not be interpreted in favour of either one of them.

6.15 Third Party Reliance

The Parties acknowledge and agree that the Senior Lenders shall have the benefit of Sections 6.3 and 6.13 and may rely upon only these provisions as if they were parties to this Agreement.

[SIGNATURE PAGE FOLLOWS]

Each of the undersigned hereby irrevocably offers to purchase the Assets on the terms and conditions set forth in this Agreement. Such offer is open for acceptance by the Seller until the earlier of the following: (A) 5:00 am (ET) on the Business Day following the date upon which the Canadian Court grants the Appointment Order and the Approval and Vesting Order; (B) the date upon which the Canadian Court refuses to grant the Appointment Order and the Approval and Vesting Order; and (C) December 15, 2015 or such other date as mutually agreed to by the Parties.

9472541 CANADA INC.

Per 
Name: Arnie Tukulj
Title: Authorized Signatory

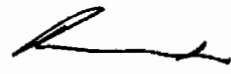
Per 
Name: Russel Orloway
Title: Authorized Signatory

9472550 CANADA INC.

Per 
Name: Arnie Tukulj
Title: Authorized Signatory

Per 
Name: Russel Orloway
Title: Authorized Signatory

635427, INC.

Per 
Name: Arnie Tukulj
Title: Authorized Signatory

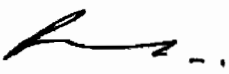
Per 
Name: Russel Orloway
Title: Authorized Signatory

652134 LIMITED

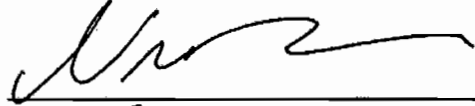
Per 
Name: Amir Tukuli
Title: Authorized Signatory

Per 
Name: Russel Ordovaz
Title: Authorized Signatory

The undersigned hereby accepts the foregoing offer on the ____ day of _____, 2015. By executing below, this Agreement becomes a fully enforceable set of agreements and obligations as between the Parties in accordance with the terms and conditions of this Agreement.

RICHTER ADVISORY GROUP INC., solely in its capacity as court appointed receiver of **THANE INTERNATIONAL, INC., THANE DIRECT, INC., THANE DIRECT CANADA INC., THANE DIRECT MARKEING INC., THANE DIRECT COMPANY, WEST COAST DIRECT MARKETING, INC. and TDG INC.** and not in its personal capacity

Per _____
Name:
Title:

SCHEDULE 1
DESCRIPTION OF CONVEYANCES OF ASSETS

Thane Receivership Company	Assets/Shares Being Sold	Purchaser
Thane International, Inc.	IP Assets	Buyer IP Co
	Other Assets	Buyer U.S. Opco
Thane Direct, Inc.	Shares – 80% equity interest in Grupo Mejor Compra SAPI de CV	Buyer Holdco
	Other Assets	Buyer Holdco
Thane Direct Company	Shares: <ul style="list-style-type: none"> • Danoz Direct Pty Ltd. • TVNS Scandanavia AB • Thane Direct UK Ltd. 	Buyer Holdco
	IP Assets	Buyer IP Co
	Other Assets	Buyer Canada Opco
	IP Licence with New Thane IPCO UK	Buyer Canada Opco
Thane Direct Marketing Inc.	Shares: <ul style="list-style-type: none"> • Medio Latino Inc. • Thane USA, Inc. 	Buyer U.S. Opco
	Other Assets	Buyer Canada Opco
West Coast Direct Marketing, Inc.	Other Assets	Buyer U.S. Opco
TDG, Inc.	Other Assets	Buyer U.S. Opco
Thane Direct Canada Inc.	IP Assets	Buyer IP Co
	IP Licence with New Thane IPCO UK	Buyer Canada Opco
	Other Assets	Buyer Canada Opco

Note that in the foregoing chart “Other Assets” refers to any asset owned by a Debtor except Intellectual Property, Intellectual Property licence rights pursuant to the Intellectual Property Licence Agreements and Excluded Assets described in the Offer. Other Assets can include Debtor Contracts, equipment, inventory and Accounts Receivable, as applicable.

SCHEDULE 2
EXCLUDED CONTRACTS [SECTION 2.2.2]

1. Lease with respect to 5255 Orbitor Drive, Suite 501, Mississauga, ON, L4W 5M6 between Thane Direct Canada Inc and Polaris Realty (Canada) Inc.
2. Contract between SSG Capital Advisors LLC and Thane Direct Inc. dated June 23, 2014

SCHEDULE 3

INTELLECTUAL PROPERTY [SECTION 1.1.34]

See attached.

Copyright Applications and Registrations (all in name of Thane International, Inc.)

As of October 12, 2015

U.S. Registrations

	Title	Registration Nr.
1.	AlphaMax "HydroMax 119."	PA 1-146-569
2.	Slim 'N Lift retail box.	VA 1-642-336
3.	Klear action: v. 18.	PA 1-205-635
4.	Klear action: v. 19.	PA 1-205-634
5.	Orbitrek platinum V6.	PA 1-201-544
6.	Thane products website S1.	VA 1-294-369
7.	Youth cocktail: v. 20.	PA 1-204-590
8.	Ageless wonders radio show / Bob & Denise.	SRu 547-577
9.	Flavorwave Oven DELUXE Owner's Manual Care & Use Guide.	TX 7-049-322
10.	Flavorwave Oven DELUXE Recipe Book Cover, front & back.	VA 1-666-177
11.	Slim 'N Lift SILHOUETTE retail box.	VA 1-649-220
12.	Klear action.	PAu 2-879-521
13.	Klear action homepage.	TX 6-189-752
14.	Klear action infomercial.	PA 1-283-422
15.	Klear action shade guide.	TX 6-200-740
16.	Klear action user's guide.	TX 6-188-177
17.	Orbitrek Platinum Webpage.	VA 1-694-781
18.	Slim 'N Lift Silhouette SUPREME retail box.	VA 1-638-538
19.	Slim 'N Lift Silhouette webpage.	VA 1-694-779
20.	Slim 'N Lift Slimming Tube ad photo & text.	VA 1-648-689
21.	TRUE COVER product webpage on internet website, http://www.thane.inc. , and in hyperlinks within.	VA 1-638-374
22.	Slim Lift Silhouette: California Beauty package insert.	VA 1-687-720
23.	Slim 'n Lift Silhouette SUPREME, 2-minute webclip.	PA 1-616-408
24.	Slim 'N Lift Silhouette Supreme webpage.	VA 1-694-773
25.	Slim 'N Lift SUPREME COMFORT package insert/product instructions.	VA 1-650-744
26.	9 minute marinator instructional manual & recipe guide.	TX 6-576-439
27.	9 Minute Marinator product information page on internet website, http://www.Thane.com . and in hyperlinks within.	VA 1-687-283
28.	California Beauty Steam Styler product information on page on internet website, http://www.thane.com and in hyperlinks within.	VA 1-687-285
29.	H2O Mop Marketing Photo.	VA 1-629-803
30.	H2O Mop infomercial, 2:04 clip.	PA 1-616-699
31.	H2O Mop User's Guide--cover, front & back.	TX 6-835-804
32.	H2O Mop webpage.	VA 1-694-775
33.	H2O Vac webpage.	VA 1-694-774
34.	Orbitrek Elite Webpage.	VA 1-694-772
35.	H2O Vac Turbo webpage, #4.	VA 1-650-731
36.	KLEAR ACTION instruction insert.	VAu 1-005-556

Copyright Applications and Registrations (all in name of Thane International, Inc.)

As of October 12, 2015

	Title	Registration Nr.
37.	Slim 'n Lift SUPREME COMFORT, 2-minute webclip.	PA 1-619-197
38.	Slim 'N Lift SUPREME COMFORT retail box.	VAu 973-396
39.	Thane Housewares FlavorWave Oven Turbo User's Guide.	TX 6-834-889
40.	Flavorwave Turbo clip.	PA 1-614-074
41.	H2O Mop product page, 2008-July-28 Canada, at internet website http://www.thaneinc.com .	VA 1-657-106
42.	H2O Mop Steam Cleaner retail box.	VA 1-648-870
43.	H2O Mop Ultra User's Guide.	TX 6-879-258
44.	H2O Vac Turbo infomercial, 2:17 clip.	PA 1-614-063
45.	H2O Vac TURBO Owner's Manual.	TXu 1-591-771
46.	H2O Vac Turbo Product Webpage.	VA 1-694-912
47.	H2O Vac Turbo webpage, #2A.	VA 1-648-799
48.	H2O Vac Turbo webpage, #2B.	VA 1-648-796
49.	CB Steam Styler product page at internet website http://www.thaneinc.com .	VA 1-638-423
50.	Collection of four (4) H2O Mop Ultra pre-marketing photos.	VAu 967-225
51.	Don Sullivan's "Secrets To Training the Perfect Dog": The DogFather.	VA 1-638-537
52.	FlavorWave Oven Turbo deluxe accessory box.	VAu 967-645
53.	FlavorWave Oven Turbo extender ring box.	VAu 967-464
54.	FlavorWave Oven Turbo: New Generation in Cooking (retail box).	VAu 965-467
55.	FLAVORWAVE OVEN TURBO product webpage on internet website, http://www.thane.com , and in hyperlinks within.	VA 1-634-246
56.	FlavorWave Oven Turbo recipe cards.	VA 1-655-996
57.	FlavorWave Oven Turbo retail box 2, with Mr. T.	VA 1-655-825
58.	H2O Mop ULTRA retail box.	VAu 991-738
59.	Slim 'n Lift SUPREME COMFORT internet webpage, rev.1.	VA 1-666-305
60.	ABTRONIC X2 retail box.	VA 1-731-272
61.	CONTACT BODYBLAST, 1:29 webclip.	PA 1-660-304
62.	CONTACT BODYBLAST Instructions.	VAu 1-004-533
63.	CONTACT BODYBLAST internet webpage.	VA 1-686-415
64.	CONTACT BODYBLAST Workout DVD cover.	VAu 1-004-530
65.	CONTACT BODYBLAST Workout DVD labels, Disc 1 & Disc 2.	VAu 1-004-532
66.	H2O Mop ULTRA, 2:28 webclip.	PA 1-66-4668
67.	H2O Mop ULTRA 3 in 1 Steamer.	VA 1-690-812
68.	H2O Mop ULTRA internet webpage.	VA 1-667-380
69.	3 MINUTE LEGS, 2:23 webclip.	PA 1-695-633
70.	3 MINUTE LEGS internet webpage.	VA 1-677-938
71.	3ML Total Transformations, User's Guide, with 3ML Accelerated Results and 3ML Totally Tasty.	TXu 1-639-481
72.	AB DOER TWIST, 1:50 webclip.	PA 1-693-151
73.	AB DOER TWIST internet webpage.	VA 1-688-307

**Copyright Applications and Registrations (all in name of Thane International, Inc.)
As of October 12, 2015**

	Title	Registration Nr.
74.	AB DOER TWIST internet webpage, Rev.1.	VA 1-739-113
75.	AB DOER TWIST Quick Start Guide, with AB-DOer Twist Accelerated Results and AB-DOer Twist Healthy Eating Plan.	TXu 1-654-297
76.	ABTRONIC X2 belt artwork.	VA 1-734-182
77.	ABTRONIC X2 internet webpage, English version.	VA 1-713-915
78.	AB DOER TWIST retail box.	VA 1-741-940
79.	DERMA SETA internet webpage.	VA 1-715-485
80.	DERMA SETA internet webpage, Canada.	VA 1-731-269
81.	DERMA SETA internet webpage, U.K.	VA 1-731-316
82.	DERMA SETA retail box.	VA 1-731-116
83.	FLAVORWAVE OVEN EXPRESS retail box, English version.	VAu 1-045-431
84.	Slim 'N Lift AIRE internet webpage.	VA 1-734-177
85.	Slim 'N Lift AIRE package inserts.	VAu 1-037-782
86.	Slim 'N Lift AIRE retail box.	VAu1-037-658
87.	Slim "N Lift SUPREME COMFORT webpage.	VA 1-648-663
88.	TOTAL VIBES internet webpage.	VA-1-750-135
89.	ABTRONIC X2 retail box.	VA 1-731-272
90.	ABTRONIC X2 Diet Plan.	TX-7-306-246
91.	GO! GO! Manuals, for Nails & Heels.	TXu 1-719-481
92.	TOTAL FLEX User's Guide (English).	TXu 1-723-000
93.	H2O Mop X5 retail box.	VAu 1-047-642
94.	Slim 'N Lift AIRE webpage, rev. 1.	VA 1-749-594
95.	FLAVORWAVE OVEN EXPRESS product intro thumbnail & Coming Soon webpage.	VA 1-752-757
96.	H2O Mop X5 product intro thumbnail & pre-order page.	VA 1-752-756
97.	TOTAL FLEX webpage.	VA 1-753-012
98.	TOTAL FLEX product intro thumbnail.	VA 1- 753-494
99.	FLAVORWAVE OVEN TURBO webpage, V.2.	VA 1-754-313
100.	H2O Mop X5 retail box 2.	VA 1-759-533
101.	AB DOER TWIST Extreme Workout DVD cover.	VA 1-759-529
102.	TOBI Steam Wand webpage.	VA 1-766-328
103.	TOBI Platinum webpage.	VA 1-766-332
104.	FLAVORWAVE OVEN EXPRESS Digital Model User's Guide.	TXu 1-725-130
105.	H2O Mop X5 User's Guide.	TXu 1-725-942
106.	TOTAL FLEX exercise wall chart.	TXu 1-728-301
107.	TOBI Steam Wand instruction manual.	TX 7-361-797
108.	H2O Mop X5 product internet webpage.	VA 1-176-201
109.	Slim 'N Lift AIRE Bra retail box.	VAu 1-060-542
110.	VAC X5 retail box.	VAu 1-060-534
111.	H2O Mop X5 replacement pads retail box.	VA 1-060-856

Copyright Applications and Registrations (all in name of Thane International, Inc.)

As of October 12, 2015

	Title	Registration Nr.
112.	TOBI Platinum retail box, int'l vers.	VA 1-766-314
113.	H2O Mop X5 Coral Cloth Replacement Pads retail box.	VAu 1-064-372
114.	ROCKIN' ABS product info thumbnail & test page, U.S.	VA 1-775-087
115.	SONA PILLOW product info thumbnail & test page, U.S.	VA 1-777-114
116.	H2O Vac TURBO webpage, #3.	VA 1-777-278
117.	DERMA SETA, 2:11 webclip, English.	PA 1-750-059
118.	DERMA SETA, 2:11 webclip, French.	PA 1-750-058
119.	ABTRONIC X2. 1:35 webclip, German.	PA 1-744-488
120.	DERMA SETA Spa Instructional video.	PA-1-744-524
121.	SNL AIRE webclip.	PA 1-745-629
122.	FLAVORWAVE OVEN EXPRESS packaging inserts: User's Guide, Mr. T's Healthy Recipes, New Generation in Cooking recipes.	TXu 1-756-533
123.	AB DOER TWIST Let's Get Started + 3 Workouts DVD artwork.	VA 1-777-515
124.	ROCKIN' ABS User's Guide.	TXu 1-750-352
125.	ROCKIN' ABS Healthy Eating Plan.	TX 7-398-053
126.	H2O Mop X5 U.S. retail box.	VAu 1-068-293
127.	SNL AIRE Bra retail box, rev. July 2011.	VAu 1-072-358
128.	TOTAL FLEX workout DVD artwork.	VA 1-785-414
129.	SNL AIRE Bra retail box, 3-bra set.	VA 1-076-988
130.	SNL AIRE retail box, France.	VA 1-076-990
131.	AB DOER TWIST internet microsite.	VA 1-787-175
132.	ROCKIN' ABS internet microsite.	VA 1-787-171
133.	Flavorwave Oven Turbo webpage, V. 2, Parts & Accessories.	VA 1-787-177
134.	TOTAL FLEX internet microsite.	VA 1-787-169
135.	Flavorwave Oven Turbo internet microsite, Home & FAQ pages.	VA 1-787-170
136.	4 Klear Action product labels.	TXu 1-765-985
137.	PERFECT Dog webpage, Thane V.2.	VA 1-789-984
138.	ABTRONIC X2 Dual Channel Fitness Belt Instructions (joint w/ AbtronicX2/Red Lemon).	TX 7-427-370
139.	AB DOER TWIST Let's Get Started + 3 Workouts DVD.	PA 1-765-649
140.	STIKTILE product info thumbnail & test page, U.S.	VA 1-798-118
141.	AGELESS WONDER Facial Muscle Stimulation System Instructions For Use.	TXu 1-780-386
142.	THUNDERSTICK retail box.	VAu 1-083-183
143.	VAC X5 Vacuum Cleaner User's Guide.	TXu 1-725-132
144.	TOBI Steam Wand retail box.	VAu 1-048-202
145.	GO! GO! webpage.	VA 1-749-271
146.	TOTAL FLEX, set of 8 product promotional webclips.	PA 1-755-847
147.	TOBI Steam Wand 2:11 webclip.	PA 1-756-062

Copyright Applications and Registrations (all in name of Thane International, Inc.)

As of October 12, 2015

148.	3-in-1 booklet featuring Briana's 6 Week Healthy and Delicious Weight Loss Program, Lynn Fischer's Healthy Decadent Desserts and Tony Little's Smoothie Sensations.	TXu 1-773-131
149.	ThunderStick Food Processor User's Guide, Model FP9017-A (120V) and ThunderStick Food Processor User's Guide, Model FP9017-A (220-240 V).	TXu 1-773-120
150.	FlavorStone Family Favorites & Tasty Sensations.	TXu 1-785-716
151.	FlavorStone Cooking & Wash Care Guide.	TXu 1-784-864
152.	STEELABS 2 Workout DVD labels.	VAu 1-085-864
153.	STEELABS Healthy Eating Guide and 7-Day Slim Down Guide (2-in-1 booklet).	TXu 1-785-348
154.	STEELABS User's Guide.	TXu 1-785-347
155.	STEELABS Coming Soon webpage, Canada.	VA 1-799-153
156.	STEELABS Coming Soon webpage, U.S.	VA 1-799-133
157.	H2O MOP X5 product internet webpage, Rev. 1.	VA 1-801-586
158.	FLAVORWAVE OVEN EXPRESS webpage.	VA1-804-006
159.	Klear Action retail box.	VAu 1-096-960
160.	H2O VAC Turbo retail box.	VAu 1-095-829
161.	H2O Mop User's Guide, in full.	TX 7-534-960
162.	DERMA SETA User Guide.	TX 1-797-450
163.	AB DOER TWIST Track Your Results Motivational Calendar wall chart.	VA 1-813-767
164.	TOBI Platinum webclip.	PA 1-787-555
165.	H2O Mop X5 2:36 webclip.	PA 1-784-804
166.	AB DOER TWIST Extreme Workout DVD.	PA 1-784-803
167.	ROCKIN' ABS product infomercial.	PA 1-787-549
168.	SONA PILLOW product infomercial.	PA 1-787-542
169.	H2O Mop X5 infomercial.	PA 1-786-953
170.	FlavorStone Cooking & Wash Care Guide, Rev.1.	TXu 1-800-376
171.	FLAVORSTONE product internet webpage, V.2.	VA 1-812-648
172.	SWIVEL SWEEPER G2 product webpage images & text.	VA 1-812-663
173.	RED FUSION Instructions For Use.	TXu 1-801-886
174.	PERFECT DOG retail boxes (large & small collars).	VA 1-812-553
175.	RED FUSION full set retail box.	VAu 1-096-392
176.	RED FUSION product webpage images & text.	VA 1-812-549
177.	AGELESS WONDER set of retail boxes, English & English/Spanish.	VAu 1-096-252
178.	ORBITREK X2 Owner's Manual.	TXu 1-808-936
179.	STIKTILE product infomercial.	PA 1-799-033
180.	FLAVORSTONE product internet webpage.	VA1-824-196
181.	FLAVORSTONE, 3:49 webclip.	PA 1-806-747
182.	STEELABS infomercial.	PA 1-806-537
183.	H2O MOP X5 Italy retail box.	VAu 1-103-774

Copyright Applications and Registrations (all in name of Thane International, Inc.)

As of October 12, 2015

184.	HANGWELLS product webpage images & text.	VA 1-823-642
185.	ORBITREK X2 product webpage images & text.	VA 1-823-594
186.	ORBITREK X2 - 3 Workouts DVD label.	VAu 1-103-780
187.	AB DOER TWIST product webpage images & text, 2012 rev.1.	VA 1-823-599
188.	FLAVORSTONE Master Set retail box.	VAu1-103-772
189.	TOTAL FLEX retail box labels. 2 (French & English).	VA 1-823-616
190.	ORBITREK X2 retail box label.	VAu 1-103-775
191.	ORBITREK X2 retail box label with Before & After photos.	VAu 1-108-660
192.	FLAVORSTONE infomercial.	PA1-813-383
193.	ORBITREK X2 - 3 Workouts DVD.	PAu 3-641-568
194.	ORBITREK X2 3:38 webclip.	PA 1-812-331
195.	ORBITREK X2 product infomercial.	PA 1-812-330
196.	H2O SteamEffect User's Guide.	TXu 1-829-421
197.	H2O Mop X5 Elite model User's Guide.	TX 7-602-858
198.	H2O SteamFX User's Guide.	VAu 1-117-207
199.	H2O SteamFX retail box.	VAu1-117-207
200.	TOTAL FLEX DVD cover.	VA1-841-094
201.	TOTAL FLEX Healthy Eating Plan.	TXu 1-835-902
202.	SLIM 'N LIFT ("SNL") 4 retail package sleeves (SNL Aire, SNL Aire Bra Embrace, SNL Caresse & SNL Sheer Secret).	VAu 1-117-204
203.	H2O Mop X5, 3 scent labels (Alpine Sensations, Tuscan Breeze & Tropical Zest).	VAu 1-117-201
204.	TOTAL FLEX Workout DVD with Kim Lyons.	PA 1-819-150
205.	FLAVORWAVE OVEN TURBO webpage, V.3.	VA1-803-523
206.	URBAN SECRET, 6 product labels.	VAu 1-126-645
207.	NANO GYM exercise chart.	VAu1-117-535
208.	NANO GYM product webpage images & text.	VA 1-841-678
209.	TRUE COVER 2012 product webpage images & text.	VA 1-833-517
210.	TRUE COVER REDEFINED retail box.	VAu1-120-550
211.	TOTAL FLEX 2012 product infomercial.	PA 1-823-049
212.	NANO GYM product infomercial.	PA 1-823-049
213.	NANO GYM 3:49 webclip.	PA 1-831-205
214.	TRUE COVER REDEFINED 3:35 webclip.	PA 1-823-360
215.	TRUE COVER REDEFINED infomercial.	PA 1-823-374
216.	TRUE COVER REDEFINED infomercial, Spanish version.	PA 1-823-372
217.	FLAVORSTONE product line catalog.	TXu 1-842-134
218.	H2O water softener product image & label.	VAu 1-120-171
219.	H2O Mop X5 Tropical Zest free sample card & sachet packet.	VAu 1-126-673
220.	H2O Mop X5 Tropical Zest free sample card.	VAu 1-126-697
221.	TOBI product webpage images & text.	VA 1-839-747
222.	TRUE COVER REDEFINED Application Guide.	TX 7-611-371

Copyright Applications and Registrations (all in name of Thane International, Inc.)

As of October 12, 2015

223.	SLIM 'N LIFT AIRE BRA Music Video.	PA 1-835-209
224.	SLIM 'N LIFT CARESSE product webpage images & text.	VA 1-856-940
225.	H2O Mop X5 product image in 4 colors (white, purple, black & red).	VA 1-864-962
226.	PERFECT Dog webpage, Thane V.1.	VA1-789-985
227.	SLIM 'N LIFT AIRE BRA Sparkles retail sleeve.	VAu-134-767
228.	TRUE SLEEPER product promotional images.	VA1-865-012
229.	H2O SteamFX product webpage images & text.	VA1-864-995
230.	H2O Mop X5 product webpage images & text, V.3.	VA 1-865-327
231.	H2O Mop X5 product webpage images & text, V.4. (includes material from VA1-801-586; EDR 2012-Jan-13).	VA 1-865-381
232.	H2O Mop X5 Elite package web images & text.	VA 1-865-326
233.	FlavorChef retail box.	VAu 1-135-058
234.	FlavorFresh 2 min. product commercial.	PAu 3-685-778
235.	AGELESS WONDER retail box #2.	VA1-103-726
236.	5-piece Knife Block set retail box (Ver130813); Knife set Safety & Care Guides (for 4-piece & 6-piece.sets).	VAu1-145-437
237.	3 FlavorStone retail boxes: 4-piece Red Master set, Generic (Ver130729); 4-piece Red Master set, with Detachable handle & thermo lid (Ver131001); 7-piece Red Grande set (Ver130905).	VAu1-145-430
238.	FlavorChef steak knife set Safety & Care Guide (130919).	VAu1-150-784
239.	FlavorChef Care Guide for silicone & metal inserts, English & French (131018).	VAu1-150-783
240.	2 FlavorFresh retail sleeves: 5-pc Green set (130913) & 10-pc Clear & Green set (130911).	VAu 1-150-952
241.	RED FUSION retail box.	VAu 1-096-390
242.	RED FUSION 1:48 webclip.	PA 1-876-548
243.	AGELESS WONDER product webpage images & text.	VA 1-888-627
244.	SUDDEN GLOW product webpage images & text.	VA 1-833-518
245.	FLOW FORM exercise charts (General Exercise Chart and Pilates Exercise Chart).	VAu 1-110-835
246.	AB COMMAND retail box.	VAu 1-117-413
247.	TOTAL FLEX User's Guide (for mini model).	TXu1-835-741
248.	TOTAL FLEX Ab Developer User's Guide.	TXu 1-835-747
249.	H2O Mop X5 cleaning accessories & attachments catalog.	TXu 1-871-426
250.	SLIM 'N LIFT CARESSE product webpage images & text, V.2.	PA 1-865-000
251.	FlavorQuik User's Guide (120V) & FlavorQuik User's Guide (240V).	TXu1-872-608
252.	FlavorQuik Recipes booklets (Healthy Smoothies and Tips for Better Living, et. al.).	TXu 1-880-993
253.	FlavorStone Quick & Easy Recipes by Herb Mesa.	TXu 1-878-340
254.	FlavorFresh retail packaging.	VAu 1-155-050
255.	H2O X2 User's Guide (Ver130911).	TXu 1-884-455
256.	FlavorChef User's Guide (GS131025) and FlavorChef User's Guide (UL131025).	VAu 1-158-092

Copyright Applications and Registrations (all in name of Thane International, Inc.)

As of October 12, 2015

257.	H2O X5+ retail box (131024).	VAu 1-155-206
258.	FlavorQuik retail box (131108).	VAu 1-157-078
259.	Ageless Wonder retail box #3, EU (131108).	VAu 1-154-259
260.	SLIM 'N LIFT INFUSED retail box (131114).	VAu 1-154-258
261.	FLAVORSTONE, 4 glass lids retail boxes (131121).	VAu 1-154-136
262.	H2O X2 retail box (131126).	VAu 1-154-257
263.	H2O Scents product info sheet & Lavender scent label (140102).	VA 1-891-535
264.	FlavorStone Red 5 knives & block set box (140120).	TXu 1-887-516
265.	FlavorChef retail box & warranty (Engl. & Fr.) (140106).	VAu 1-155-890
266.	FlavorChef w/ 30m Glass Lid retail box (131219).	VAu 1-155-889
267.	FlavorChef Recipe Guide (130828).	TXu 1-896-582
268.	SLIM 'N LIFT INFUSED infomercial, Int'l.	PA 1-899-185
269.	FLAVORSTONE blue grill pan box 131204.	VAu 1-166-105
270.	Slim 'N Lift Infused product webpage images and text.	VA 1-905-185
271.	SLIM 'N LIFT INFUSED FAQ, 131203.	TX 7-829-336
272.	H2O X5 Accessories, 5 UK retail boxes (130912), Elite, Microfibre Cloths, Premium Pack, Super Absorbent Cloths, Super Clean.	VAu 1-165-847
273.	X5 Vac User's Guide, 131212.	TXu 1-895-313
274.	Slim 'N Lift Men's Slimming Shirt (Core Shaper) retail box.	VA1-901-309
275.	X5 Vac retail box 140211.	VAu 1-166-502
276.	Slim 'N Lift Infused Product Info Sheet 130809.	VA 1-908-360
277.	Slim 'N Lift Infused Product Info Sheet 130913.	VA 1-908-365
278.	X5 Vac retail box 140321.	VAu 1-169-439
279.	H2O X5 User Manual (UK).	VAu 1-173-432
280.	2 FlavorStone 7-piece Grande Set retail boxes: Generic set and Deluxe set with Detachable Handle and Thermo lid (131205).	VAu 1-178-745
281.	SLIM 'N LIFT INFUSED infomercial, US.	PA 1-905-934
282.	FlavorFull, set of 3 retail boxes (GS), for green (140415), red (140415) & white (140521).	VAu 1-182-436
283.	Slim n Lift Caresse Jeans product info sheet (140612).	VAu 1-177-302
284.	FlavorStone (Blue) Grande Set product info sheet (140620).	VAu 1-177-301
285.	X5 Vac product webpage images and text (thane.ca).	VA 1-918-988
286.	FlavorFull product webpage images and text (thane.ca).	VA 1-919-921
287.	FlavorQuik product webpage images and text (thane.ca).	VA 1-919-125
288.	H2O SteamFX product webpage images and text (thane.ca).	VA 1-919-126
289.	Slim n Lift Caresse Jeans retail box (140710).	VAu 1-178-388
290.	X5 Vac product webpage images and text (thane.com).	VA 1-922-851
291.	FlavorFull product webpage images and text (thane.com).	VA 1-922-851
292.	Slim n Lift Caresse Jeans retail box (140711), Spanish.	VAu 1-179-049

Copyright Applications and Registrations (all in name of Thane International, Inc.)

As of October 12, 2015

293.	FlavorStone, 3 retail boxes, 28 cm deluxe deep pan w detach handle, colors (Blue, Red, Dk Gray) (140710).	VAu 1-179-031
294.	FlavorStone (Red) retail box for 3-piece Saute Pan Set, 20 cm 24 cm 28 cm (140723).	VAu 1-178-956
295.	3 FlavorStone (Red) retail packaging sleeves, for 20cm, 24cm & 28 cm Saute pans (140306).	VA 1-920-856
296.	5 FlavorStone (Red) retail boxes, for varying 24cm pans.	VA 1-920-791
297.	FlavorStone (Red) retail box for 16cm Sauce Pan w Lid (140503).	VA 1-920-788
298.	The Ultimate Juicer retail box (140731).	VAu 1-178-953
299.	Slim n Lift Caresse Jeans retail box and retail sleeve (140806).	VAu 1-178-973
300.	Slim n Lift Caresse Jeans retail box, Spanish (R1, 140812).	VAu 1-178-933
301.	FlavorStone, 3 retail boxes, 20 cm saute [sic—should be "sauce" pan w lid, in colors Blue (140822), Red & Dk Gray (140821).	VAu 1-178-900
302.	FlavorStone, 3 retail boxes, for 32 cm saute pan w lid, in colors Blue (140723), Red & Dk Gray (140826).	VAu 1-178-899
303.	FlavorStone (Blue), 4 retail boxes, for varying 28cm pans (140507, 140528, 140619, 140820).	VAu 1-178-897
304.	FlavorStone (Red), 2 retail boxes, for varying 24cm pans (140325, 140505).	VA 1-920-751
305.	Slim n Lift AIRE set of 7 garment wearing instructions (140515).	TXu 1-910-438
306.	AbTronic X2 Diet & Workout Plan 140410.	TXu 1-910-593
307.	AbTronic X2 - 2 Product Use Guides (First Use Guide 140415 and Instruction Manual 140422).	TXu 1-910-585
308.	FlavorFull User's Guide (2 sets, ETL & GS (141010).	TXu 1-911-272
309.	Slim n Lift AIRE Lace Slip garment wearing instructions (140522).	TXu 1-911-460
310.	H2O HD product info sheet (140906) (sic—should be 140905).	VAu 1-184-254
311.	H2O PowerX product info sheet (140905).	VAu 1-184-283
312.	H2O HD retail box (140909).	VAu 1-184-387
313.	Rockin' Abs product info sheet (140908).	VAu 1-184-989
314.	FlavorMaster product info sheet (140910).	VAu 1-184-863
315.	FlavorStone Red (Translucent) product info sheet (140917).	VAu 1-185-314
316.	FlavorFull 6 Week Menu Planner (140408), FlavorFull Healthy Eating Recipe Book (140410).	TX 7-916-337
317.	Ab Command, Diet Plan & First Use Guide (130409) & User's Manual (130410).	TX 7-934-196
318.	H2O Mop X3 U.S. retail box (130111).	VA 1-933-842
319.	H2O HD User's Guide, Model KB-019 (140708).	TXu 1-914-985
320.	FlavorFull 6 Week Menu Planner (140408), FlavorFull Healthy Eating Recipe Book (140410).	TX 7-945-557
321.	H2O PowerX User's Guide (140825).	TXu 1-918-903
322.	Bullworker Pro retail box (140905).	VAu 1-184-219
323.	H2O Scents, 3 retail labels, Lavender, Orange and Pine (140129).	VAu 1-186-657

Copyright Applications and Registrations (all in name of Thane International, Inc.)

As of October 12, 2015

324.	Slim N Lift Caresse Jeans FAQ (141029) and Package Insert (141103).	TXu-929-103
325.	H2O X5 Lite U.K. retail box (141112).	VAu 1-190-966
326.	Rockin' Abs retail box (141030).	VAu 1-190-967
327.	Rockin' Abs User's Guide (141107), 10 Workout Jump Start Program and Healthy Eating Plan (141014).	TXu 1-930-281
328.	Ab Command product labels (belt tag & gel label).	TXu 1-930-270
329.	Ab Command - 2 Product Use Guides (First Use Guide 141112 and Instruction Manual 141114).	TXu 1-930-278
330.	Ab Command Diet & Workout Plan (141114).	TXu 1-929-249
331.	Slim N Lift Caresse Jeans retail hanger packaging & instructions (141120).	VAu 1-191-986
332.	FlavorMaster User's Guide (141117).	TXu1-931-603
333.	Slim N Lift Caresse Jeans retail box (single pair) (141218).	VAu 1-196-796
334.	FlavorMaster retail box (141216).	VAu 1-197-071
335.	CrossX2 product information sheet (141219).	VAu 1-197-518
336.	Ab Command iX2 - 2 product information sheets (150108).	VAu 1-198-628
337.	Ab Command iX2 upsell kit package insert (141223).	VAu 1-198-630
338.	Slim n Lift Caresse Jeans product webpage images and text (thane.com).	VA 1-954-283
339.	FlavorMaster Recipe book (141210).	TXu 1-937-289
340.	Rockin Abs FAQ (150106).	TXu 1-937-478
341.	Ab Command iX2 Nutrition & Cardio Guide (141224).	TXu 1-930-647
342.	Ab Command iX2 - 2 Product Use Guides (First Use Guide and Instruction Manual (141224).	TXu 1-938-601
343.	Ab Command retail box (150115).	VAu1-202-152
344.	H2O PowerX retail box (150212).	VAu1-203-162
345.	Slim N Lift Caresse retail sleeve (121018).	VA1-951-051
346.	Slim N Lift Caresse Jeans retail sleeves, for animal print and for gemstones jeans (150302).	VAu1-204-484
347.	Slim N Lift Caresse Jeans skirt retail sleeves (Thane 150303 and TVINS 150306).	VAu 1-205-489
348.	Ab Command iX2 retail box (150312).	VAu 1-205-644
349.	Miracle Bamboo Pillow product info sheet, retail box & care instrux (150316, 150317 & 150325).	VAu 1-206-489
350.	CrossX2 retail box (150402).	VAu 1-208-123
351.	H2O X VAC product info sheet (Ver130920).	VAu 1-214-677
352.	4 FlavorStone (Blue) Accessories packaging: utensils box (Ver130816), pizza pan box (Ver130822), cookie sheet box (Ver130822), 20cm sauté pan sleeve (Ver130912).	VAu 1-217-073
353.	2 FlavorStone retail boxes: 4-piece Blue Master set, Generic (Ver131003), 4-piece Blue Master set, with Detachable handle & thermo lid (Ver130909).	VAu 1-216-320
354.	FlavorStone UK Retail Wrap 4pc Blue 24cm set.	VAu 1-216-323
355.	3 FlavorStone (Red) Accessories boxes: grill pan (130912), cookie sheet & pizza pan (130812).	VAu 1-216-334

Copyright Applications and Registrations (all in name of Thane International, Inc.)

As of October 12, 2015

356.	FlavorChef product info: Coating & Base (130814).	VAu 1-216-338
357.	SLIM 'N LIFT INFUSED Garment instructions. (130916).	VAu 1-216-336
358.	X5 Vac User's Guide 140213 (HSN US).	TXu 1-956-797
359.	X5 Vac User's Guide 140213 (QVC UK).	TXu 1-904-579
360.	Slim N Lift Caresse Lace Top wearing instructions (140515).	TXu 1-950-708
361.	PressurePro retail box (140911).	VAu 1-189-272
362.	Ab Command iX2 Instruction Manual R1 (150223).	TXu 1-949-869
363.	Ab Command iX2 Quick Start Guide R1 (150223) and Ab Command iX2 Nutrition & Cardio Guide R1 (150225).	TXu 1-949-870
364.	Slim N Lift Waist Shaper product information sheet (150427).	VAu1-209-375
365.	FlavorStone Red & White Pro Set UK box (150429).	VAu 1-211-565
366.	Slim N Lift Aire Bra Deluxe retail box (110909).	VA 1-962-133
367.	Nano Gym Training Area & Free Area diagrams & text (150512).	VAu 1-212-908
368.	Nano Gym Twister Seat Feature photos & text (150515).	VAu 1-213-081
369.	FlavorFresh product webpage images & text.	VA 1-962-285
370.	FlavorQuik product webpage images & text.	VA 1-962-291
371.	X5 Vac User's Guide (140213).	TXu 1-956-727
372.	RoboPal retail box (R0 150512).	VAu 1-218-334
373.	CopperX product information sheet (R0 150611).	VAu 1-219-735
374.	Slim 'N Lift Caresse Compression Jeans product information sheet (R0 150612).	VAu 1-219-736
375.	Slim N Lift Waist Shaper product information sheet (R2 150611).	VAu 1-219-824

Pending U.S. Registrations

	Short Title	Case Nr.
1.	TOTAL FLEX exercise chart.	1-824392567
2.	FlavorStone 5-piece Red knife set box (130917).	1-1005645563
3.	SLIM 'N LIFT Slimming Shirt for men retail box.	1-1024085220
4.	X5 Vac User's Guide, 140313 (3 sets, generic, HSN US and QVC UK).	1-1321369017
5.	Cross X2 User's Guide (150312).	1-2292470292
6.	Slim N Lift Waist Shaper product information sheet (150427).	1-2338310932
7.	RoboPal User's Guide (R0 150601).	1-2462236652
8.	Total Flex product webpage images & text 2015 (thane.ca).	1-2462135197
9.	Slim N Lift Waist Shaper wearing instructions (R1 150612).	1-2475406682
10.	H2O PowerX User's Guide (R2 150702).	1-2595526322
11.	Slim 'N Lift Waist Shaper retail box (R0 150729).	1-2595526451
12.	Slim 'N Lift Caresse Jeans product webpage images and text (U.K.).	1-2598309822
13.	H2O PowerX product webpage images and text (thane.ca).	1-2618380602
14.	Slim 'N Lift Caresse Lace Top retail box (R0 150820).	1-2659752487
15.	AbTronic X2 webpage, rev. 2014 (thane.ca).	1-2711282822
16.	FlavorStone InfusionGrill product information sheet (R1 150914).	1-2711216492

Copyright Applications and Registrations (all in name of Thane International, Inc.)

As of October 12, 2015

	Short Title	Case Nr.
17.	Jegeeze product information sheet (R0 150908).	1-2711301644
18.	SlimFit product information sheet (R0 150908).	1-2713493432
19.	Slim 'N Lift Perfect Fit product information sheet (R0 150909).	1-2713893592
20.	FlavorChef Express Kitchen System product information sheet (R0 150918).	1-2716971727
21.	Slim 'N Lift Caresse Compression Jeans retail box 3 set (R0 150916).	1-2716724252
22.	FlavorStone InfusionGrill product information sheet (R1 150918).	1-2717259723
23.	Slim 'N Lift Perfect Fit product information sheet (R0 150921).	1-2728600702
24.	H2O HD DualBlast product information sheet (R0 150916).	1-2728862362
25.	H2O X5 DualBlast product information sheet (R0 150916).	1-2731687892
26.	SlimFit wearing instructions (R0 150925).	1-2737810702
27.	CopperX wearing instructions (Eng/Fr/Sp) (R0 150925).	1-2766577372
28.	Jegeeze wear instructions & Jegeeze care instructions (Eng/Fr/Sp) (R0 151008).	1-2776198472
29.	Slim N Lift Waist Shaper wearing instructions, multi-lingual (R1 151008).	1-2776252087
30.	FlavorStone UK retail labels Blue & Gray 28cm 5pc (R0 151005).	1-2778918702

OTHER REGISTRATIONS

• **ECUADOR**

	Title	Registration Nr.
1.	ABTRONIC X2 Diet Plan.	035538
2.	ABTRONIC X2 Dual Channel Fitness Belt Instructions (Product Manual).	035539
3.	Thane Housewares FLAVER [sic] WAVE OVEN TURBO Users Guide.	035540
4.	ABTRONIC X2 Retail Box.	035541
5.	ABTRONIC X2 Belt Artwork.	035542
6.	FLAVOR WAVE OVEN retail box 2 with Mr. T.	035543

**Patents and Design Registrations and Applications
Held by Thane International, Inc., Thane Direct Company
and/or Thane Direct Canada, Inc.
As of October 12, 2015**

U.S. Design Patents

Thane International, Inc.

Registered Design Patents

1. EXERCISE APPARATUS (ABDOER TWIST):
United States Design Patent D639,873
Issued: June 14, 2011
Inventor: John Abdo
Assignee: Thane International, Inc.
Appl. Nr.: 29/366,192 Filed: July 21, 2010

2. EXTENSION HANGER (HANGWELLS):
United States Design Patent D620262
Issued: July 27, 2010
Inventor: Sladjana Tukulj-Popovic
Assignee: Thane International, Inc.
Appl. Nr.: D/350,693 Filed: November 20, 2009

3. ELLIPTICAL STATIONARY EXERCISE DEVICE (ORBITREK ELITE):
United States Design Patent D569,455
Issued: May20, 2008
Inventor: Dukhande Sandeep Gopal
Assignee: Thane International, Inc.
Appl. Nr.: D/285,963 Filed: April 17, 2007

4. HEATED HAIR STYLING DEVICE (CB STEAM STYLER):
United States Design Patent D557,863
Issued: Dec. 18, 2007
Inventor: Sladjana Tukulj and Jelenko Piksa
Assignee: Thane International, Inc.
Appl. Nr.: D/285,586 Filed: May 10, 2007

5. SOLUTION BOTTLE AND CAP:
United States Design Patent D485,184
Issued: Dec. 18, 2007
Inventor: Dubarry, et al.
Assignee: Thane International, Inc.
Appl. Nr.: D/173,010 Filed: December 19, 2002

6. TRI-SOLUTION BOTTLE ASSEMBLY:
United States Design Patent D485,170
Issued: January 13, 2004
Inventor: Dubarry, et al.
Assignee: Thane International, Inc.
Appl. Nr.: D/173,009 Filed: December 19, 2002

7. MOP HEAD (prism shaped head):
Thane reference: Triple action mop head for H2O Mop X5
U.S. Design Patent D716,009
Inventor: Jelenko Piksa
Applicant: Thane International, Inc.
Appl. Nr. 29/461,478 Filed: July 23, 2013

**Patents and Design Registrations and Applications
Held by Thane International, Inc., Thane Direct Company
and/or Thane Direct Canada, Inc.
As of October 12, 2015**

Community Designs

Thane Direct Canada Inc.

- 1. Design Nr.:** 00215959-0001
Thane reference: Slim 'n Lift Silhouette
Filing Date: August 16, 2004
Locarno class nr. 21.01
Indication of the product: Women's underwear
Status: Registered and fully published (A.1)

Graphic representation:



Thane Direct Company

- 1. Design Nr.:** 000370705-0001
Reference: 6036/Swivel Sweeper
Filing Date: July 7, 2005
Locarno class nr. 15.05
Indication of the product: Vacuum cleaners, Cleaning machines
Status: Registered and fully published (A.1)

Graphic representation:

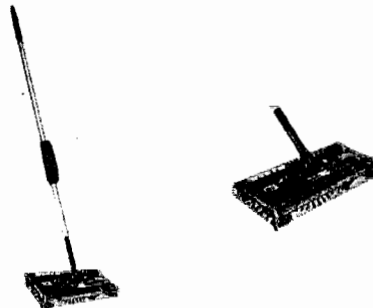

**Patents and Design Registrations and Applications
Held by Thane International, Inc., Thane Direct Company
and/or Thane Direct Canada, Inc.
As of October 12, 2015**

- 2. Design Nr.:** 000411111-0001
Reference: 6036/Swivel Sweeper
Verbal element: Battery charger
Filing Date: July 7, 2005
Locarno class nr. 13.02
Indication of the product: Accumulators, Accumulator charging apparatus
Status: Registered and fully published (A.1)

Graphic representation:



- 3. Design Nr.:** 000582887-0001
Thane reference: Slim 'n Lift Silhouette Supreme
Filing Date: September 1, 2006
Locarno class nr. 21.01
Indication of the product: Women's underwear
Status: Registered and fully published (A.1)

Graphic representation:

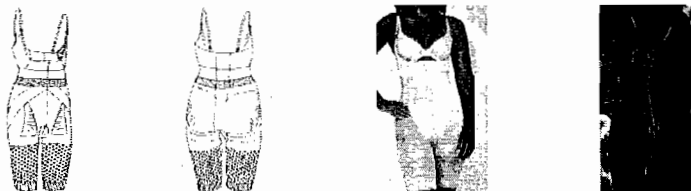

- 4. Design Nr.:** 000651831-0001 - ORBITREK
Verbal element: Orbitrek
Filing Date: January 15, 2007
Locarno class nr. 21.02
Indication of the product: Exercising apparatus
Status: Registered and fully published (A.1)

Graphic representation:

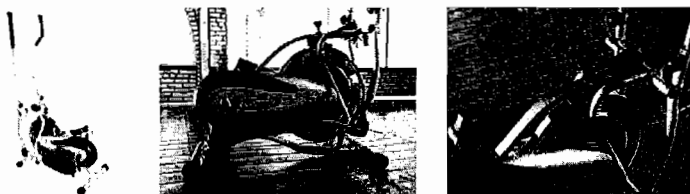

Patents and Design Registrations and Applications
Held by Thane International, Inc., Thane Direct Company
and/or Thane Direct Canada, Inc.
As of October 12, 2015

- 5. Design Nr.:** 000755699-001
Thane reference: Orbitrek
Filing Date: July 11, 2007
Locarno class nr. 21.02
Indication of the product: Training devices
Status: Registered and fully published (A.1)
Graphic representation:

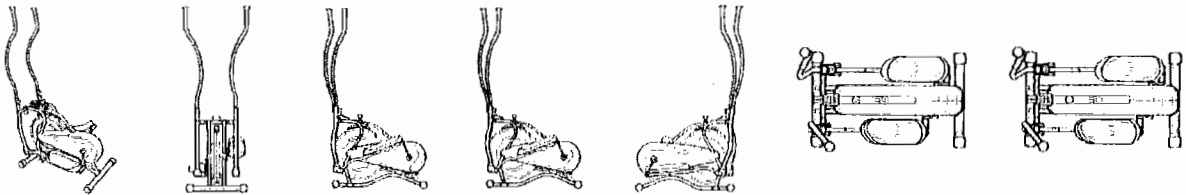

- 6. Design Nr.:** 000800792-001
Thane reference: H2O Vac Turbo
Filing Date: September 21, 2007
Locarno class nr. 15.05
Indication of the product: Vacuum cleaners
Status: Registered and fully published (A.1)
Graphic representation:

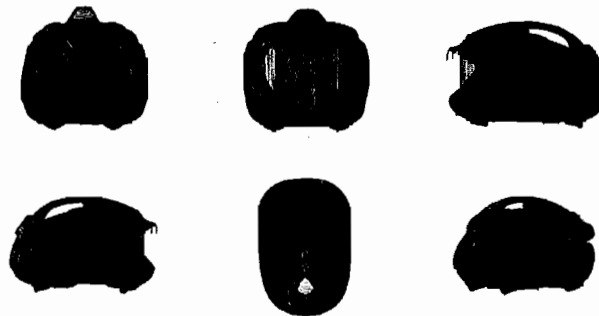

**Patents and Design Registrations and Applications
Held by Thane International, Inc., Thane Direct Company
and/or Thane Direct Canada, Inc.
As of October 12, 2015**

- 7. Design Nr.:** 000906524-0001
Thane reference: H2O Mop Ultra
Filing Date: March 31, 2008
Locarno class nr. 15.05
Indication of the product: Floor cleaning machines
Status: Registered and fully published (A.1)

Graphic representation:

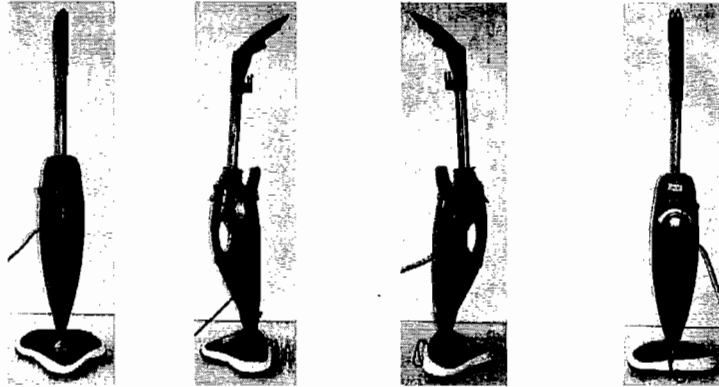

- 8. Design Nr.:** 000906524-0002 to 00906524-003, inclusive
Thane reference: H2O Mop Ultra
Filing Date: March 31, 2008
Locarno class nr. 15.05
Indication of the product: Floor cleaning machines
Status: Registered and fully published (A.1)

Graphic representation:

000906524-002

000906524-003



**Patents and Design Registrations and Applications
Held by Thane International, Inc., Thane Direct Company
and/or Thane Direct Canada, Inc.
As of October 12, 2015**

- 9. Design Nr.:** 000906524-0004
Thane reference: H2O Mop Ultra
Filing Date: March 31, 2008
Locarno class nr. 15.05
Indication of the product: Floor cleaning machines
Status: Registered and fully published (A.1)

Graphic representation:

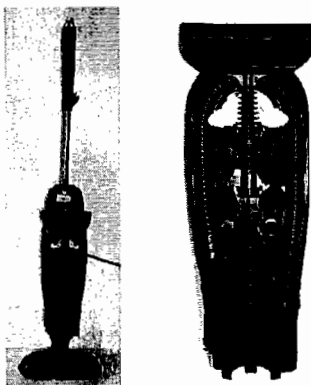

- 10. Design Nr.:** 000906524-0005
Thane reference: H2O Mop Ultra
Filing Date: March 31, 2008
Locarno class nr. 15.05
Indication of the product: Floor cleaning machines
Status: Registered and fully published (A.1)

Graphic representation:



**Patents and Design Registrations and Applications
Held by Thane International, Inc., Thane Direct Company
and/or Thane Direct Canada, Inc.
As of October 12, 2015**

11. Design Nr.: 000906524-0006 – H2O MOP ULTRA
Verbal element: H2O Mop Ultra
Filing Date: March 31, 2008
Locarno class nr. 15.05
Indication of the product: Floor cleaning machines
Status: Registered and fully published (A.1)

Graphic representation:



12. Design Nr.: 000906524-0007 – H2O MOP ULTRA
Verbal element: H2O Mop Ultra
Filing Date: March 31, 2008
Locarno class nr. 15.05
Indication of the product: Floor cleaning machines
Status: Registered and fully published (A.1)

Graphic representation:

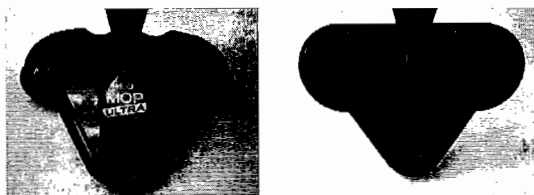

13. Design Nr.: 000906524-0008 to 000906525-0009, inclusive
Thane reference: H2O Mop Ultra
Filing Date: March 31, 2008
Locarno class nr. 15.05
Indication of the product: Floor cleaning machines
Status: Registered and fully published (A.1)

Graphic representation:

000906524-008

000906524-009

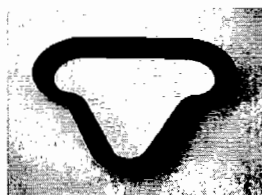

**Patents and Design Registrations and Applications
Held by Thane International, Inc., Thane Direct Company
and/or Thane Direct Canada Inc.
As of October 12, 2015**

Thane International, Inc.

- 1. Design Nr.:** 001162127-0001 to 001162127-0002, inclusive
Thane reference: Ab Doer Twist
Filing Date: September 3, 2009
Locarno class nr. 21.02
Indication of the product: Exercising apparatus
Status: Registered and fully published (A.1)
Graphic representation: 001162127-0001 001162127-0002

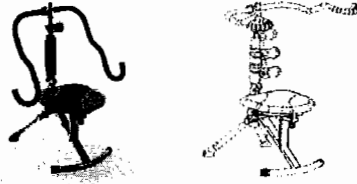

- 2. Design Nr.:** 001698713-0001 to 001698713-0002, inclusive
Verbal element: DERMA SETA
Filing Date: April 22, 2010
Locarno class nr. 28.03
Indication of the product: Cosmetic apparatus, Electric epilator devices, Cosmetic skin treatment apparatus
Status: Registered and fully published (A.1)
Graphic representation: 001698713-0001 001698713-0002

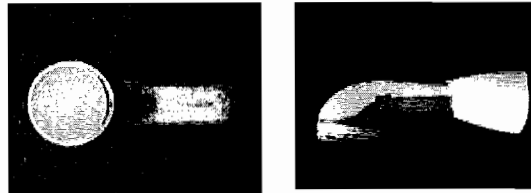

**Patents and Design Registrations and Applications
Held by Thane International, Inc., Thane Direct Company
and/or Thane Direct Canada Inc.
As of October 12, 2015**

- 3. Design Nr.:** 001698739-001
Thane reference: Derma Seta
Filing Date: April 22, 2010
Locarno class nr. 13.02
Indication of the product: Electrical chargers, Accumulator charging apparatus, Chargers
Status: Registered and fully published (A.1)
Graphic representation:



- 4. Design Nr.:** 001788605-0001
Thane reference: Ab Doer TwistEx
Filing Date: December 2, 2010
Locarno class nr. 21.02
Indication of the product: Training devices
Status: Registered and fully published (A.1)
Graphic representation:



**Patents and Design Registrations and Applications
Held by Thane International, Inc., Thane Direct Company
and/or Thane Direct Canada Inc.
As of October 12, 2015**

5. Design Nr.: 001791898-0001 to 001791898-009, inclusive
Thane reference: H2O Mop X5
Filing Date: December 10, 2010
Locarno class nr. 15.05
Indication of the product: Floor cleaning machines; and parts thereof
Status: Registered and fully published (A.1)
Graphic representation:

001791898-0001 001791898-0002

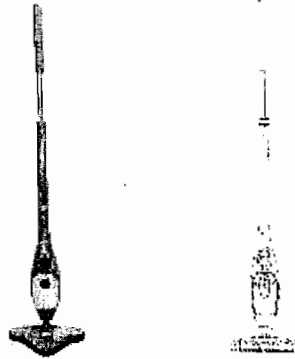

001791898-0003 001791898-0004 001791898-0005 001791898-0006 001791898-0007 001791898-0008 001791898-0009



6. Design Nr.: 001795105-0001
Thane reference: Slim 'n Lift Aire
Filing Date: December 17, 2010
Locarno class nr. 02.01
Indication of the product: Women's underwear
Status: Registered and fully published (A.1)
Graphic representation:



**Patents and Design Registrations and Applications
Held by Thane International, Inc., Thane Direct Company
and/or Thane Direct Canada Inc.**

As of October 12, 2015

- 7. Design Nr.:** 001826918-0001
Thane reference: Tobi Steam Wand
Filing Date: February 25, 2011
Locarno class nr. 07.05
Indication of the product: Steam irons
Status: Registered and fully published (A.1)
Graphic representation:



- 8. Design Nr.:** 001828864-0001
Thane reference: Tobi
Filing Date: March 2, 2011
Locarno class nr. 07.05
Indication of the product: Steam irons with steam boilers
Status: Registered and fully published (A.1)
Graphic representation:

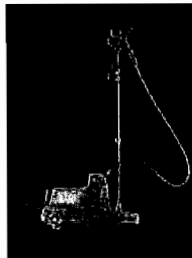

- 9. Design Nr.:** 001900465-0001
Thane reference: Total Flex
Filing Date: August 3, 2011
Locarno class nr. 21.02
Indication of the product: Exercise apparatus
Status: Registered and fully published (A.1)
Graphic representation:



Patents and Design Registrations and Applications
Held by Thane International, Inc., Thane Direct Company
and/or Thane Direct Canada Inc.
As of October 12, 2015

10. Design Nr.: 001900473-0001
Thane reference: FlavorStone
Filing Date: August 3, 2011
Locarno class nr. 32.00
Indication of the product: Surface patterns
Status: Registered and fully published (A.1)
Graphic representation:

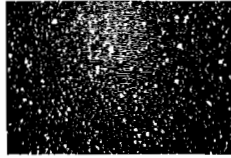

11. Design Nr.: 001900481-0001 to 001900481-0006, inclusive
Thane reference: FlavorStone
Filing Date: August 3, 2011
Locarno class nr. 07.02
Indication of the product: Cooking appliances, utensils and containers
Status: Registered and fully published (A.1)
Graphic representation:

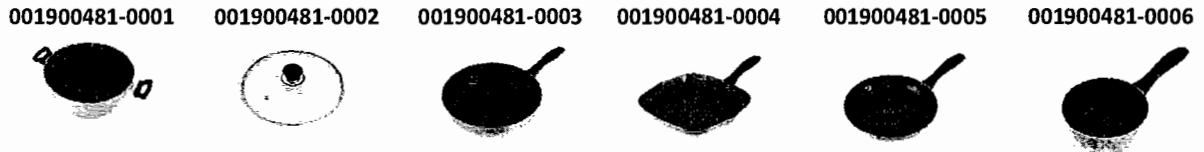

12. Design Nr.: 002164210-0001 to 002164210-0007, inclusive
Thane reference: Slim 'n Lift Caresse
Filing Date: January 9, 2013
Locarno class nr. 02.01
Indication of the product: Women's underwear
Status: Registered and fully published (A.1)
Graphic representation:

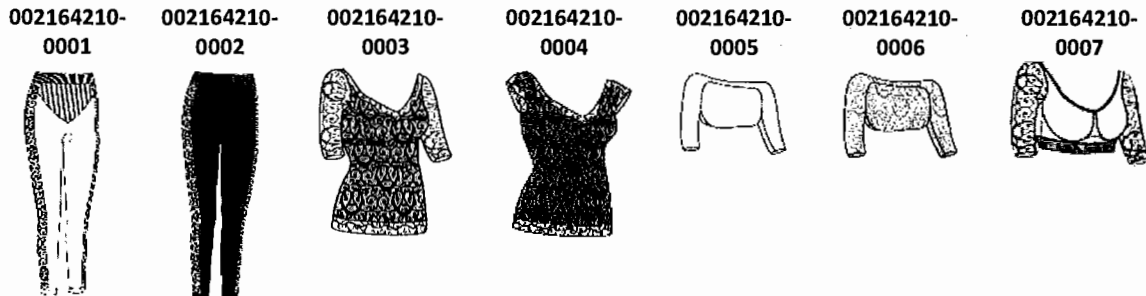

**Patents and Design Registrations and Applications
Held by Thane International, Inc., Thane Direct Company
and/or Thane Direct Canada Inc.
As of October 12, 2015**

13. Design Nr.: 002194704-0001 to 002194704-0002, inclusive
Thane reference: H2O Mop X5 triple action mop head
Filing Date: March 1, 2013
Locarno class nr. 15.05
Indication of the product: Floor cleaning machine; and part thereof
Status: Registered and fully published (A.1)
Graphic representation: 002194704-0001 002194704-0002

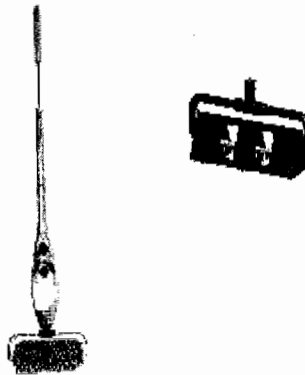

14. Design Nr.: 002364463-0001 to 002364463-0004, inclusive
Thane reference: H2O X2
Filing Date: March 1, 2013
Locarno class nr. 15.05
Indication of the product: Floor cleaning machine; and part thereof
Status: Registered and fully published (A.1)
Graphic representation: 002364463-0001 002364463-0002 002364463-0003 002364463-0003

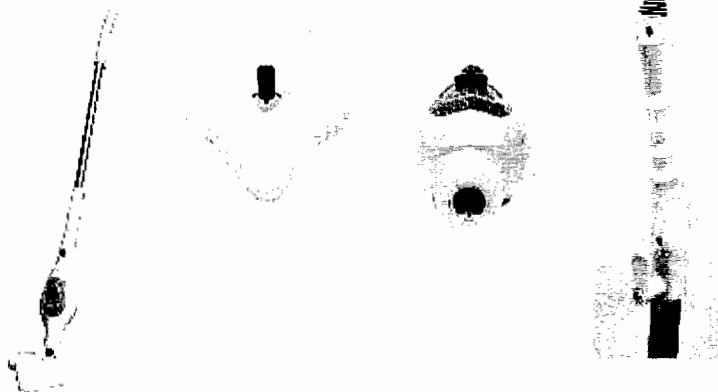

**Patents and Design Registrations and Applications
Held by Thane International, Inc., Thane Direct Company
and/or Thane Direct Canada Inc.
As of October 12, 2015**

15. Design Nr.: 002570804-0001 to 002570804-0005, inclusive

Thane reference: H2O HD

Filing Date: November 4, 2014

Locarno class nr. 15.05

Indication of the product: Floor cleaning machine; and part thereof

Status: Registered and fully published (A.1)

Graphic representation:

002570804-
0001



002570804-0002



002570804-0003



002570804-0004



002570804-0005

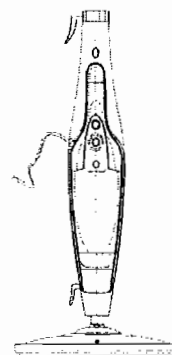

16. Design Nr.:

002583930-0001 to 002583930-0004, inclusive

Thane reference:

H2O PowerX (with triangular head)

Filing Date: November 24, 2014

Locarno class nr. 15.05

Indication of the product: Floor cleaning machine; and part thereof

Status: Registered and fully published (A.1)

Graphic representation:

002583930-
0001

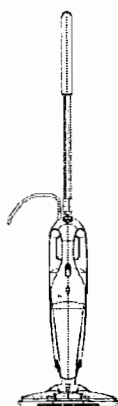

002583930-
0002





002583930-0003



002583930-0004



**Patents and Design Registrations and Applications
Held by Thane International, Inc., Thane Direct Company
and/or Thane Direct Canada Inc.
As of October 12, 2015**

- 17. Design Nr.:** 002642082-0001 to 0026420820002, inclusive
Thane reference: Ab Command iX2
Filing Date: February 2, 2015
Locarno class nr. 21.02
Indication of the product: Vibrating belts
Status: Registered and fully published (A.1)
Graphic representation: 002642082-0001 002642082-0002
- 
- 18. Design Nr.:** 002642108-0001
Thane reference: Ab Command iX2
Filing Date: February 26, 2015
Locarno class nr. 32.00
Indication of the product: Graphic representations, graphic symbols, Ornamentation
Status: Registered and fully published (A.1)
Graphic representation: 

**Patents and Design Registrations and Applications
Held by Thane International, Inc., Thane Direct Company
and/or Thane Direct Canada Inc.
As of October 12, 2015**

19. Design Nr.: 002773994-0001
Thane reference: H2O PowerX (with rectangular head)
Filing Date: September 17, 2015
Locarno class nr. 32.00
Indication of the product: Floor cleaning machines
Status: Registered and fully published (A.1)
Graphic representation:

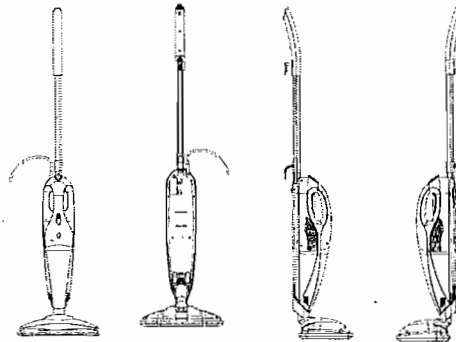

20. Design Nr.: 002773994-0002
Thane reference: H2O PowerX (with rectangular head)
Filing Date: September 17, 2015
Locarno class nr. 32.00
Indication of the product: Floor cleaning machines
Status: Registered and fully published (A.1)
Graphic representation:

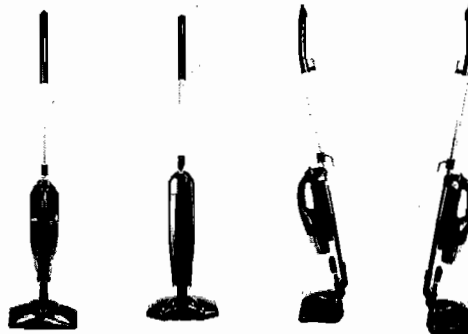

**Patents and Design Registrations and Applications
Held by Thane International, Inc., Thane Direct Company
and/or Thane Direct Canada Inc.
As of October 12, 2015**

21. Design Nr.: 002773994-0003
Thane reference: H2O PowerX (with rectangular head)
Filing Date: September 17, 2015
Locarno class nr. 32.00
Indication of the product: Floor cleaning machines (parts thereof)
Status: Registered and fully published (A.1)
Graphic representation:



22. Design Nr.: Not yet available.
Thane reference: FlavorChef Express Kitchen System
Filing Date: October 5, 2015
Locarno class nr. 31.00
Indication of the product: Mixer
Status: Pending
Graphic representation:

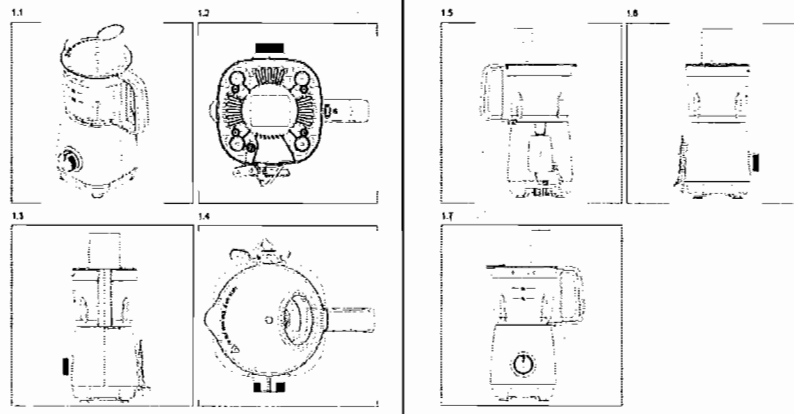

**Patents and Design Registrations and Applications
Held by Thane International, Inc., Thane Direct Company
and/or Thane Direct Canada Inc.
As of October 12, 2015**

AUSTRALIA Designs

Thane International, Inc.

- 1. Registration Nr.:** AU 316003 S
Design Nr.: 200718587
Thane reference: Orbitrek
Date Lodged: June 26, 2007
Date Registered: September 5, 2007
Classification: 21-02F
Article/Product Name: Elliptical stationary exercise device
Status: Certified (March 31, 2008)
Renewed to 1st Period: June 26, 2017
End of registration period: June 26, 2017
Graphic representation:

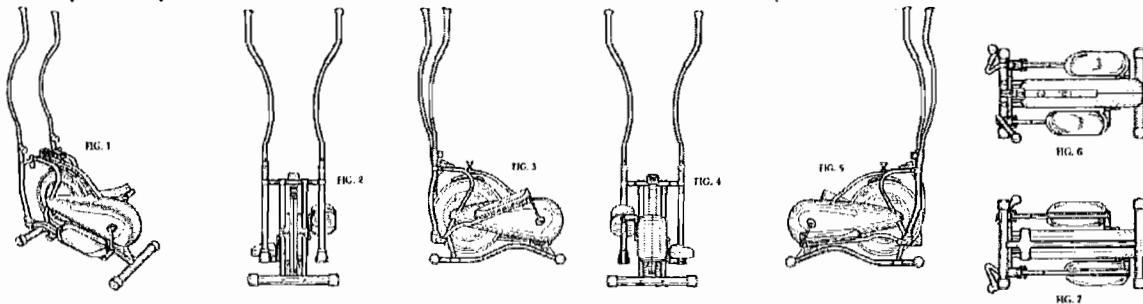

- 2. Registration Nr.:** AU 330914 S
Design Nr.: 201011719S
Thane reference: Ab Doer Twist
Date Lodged: March 2, 2010
Date Registered: May 21, 2010
Classification: 21-02F
Article/Product Name: Exercise apparatus
Status: Certified (September 20, 2010)
Renewed to 1st Period: March 2, 2020
End of registration period: March 2, 2020
Graphic representation:



**Patents and Design Registrations and Applications
Held by Thane International, Inc., Thane Direct Company
and/or Thane Direct Canada Inc.
As of October 12, 2015**

3. Registration Nr.: AU 330886 S
Design Nr.: 201010708
Thane reference: Ab Doer Twist
Date Lodged: March 2, 2010
Date Registered: May 20, 2010
Classification: 21-02F
Article/Product Name: Exercise apparatus
Status: Certified (September 20, 2010)
Renewed to 1st Period: March 2, 2020
End of registration period: March 2, 2020
Graphic representation:



4. Registration Nr.: AU 336003 S
Design Nr.: 20111165
Thane reference: H2O Mop X5
Date Lodged: March 18, 2011
Date Registered: April 13, 2011
Classification: 15:05
Article/Product Name: Steam cleaning device
Status: Certified (May 18, 2012)
Renewed to date: March 18, 2016
End of registration period: March 18, 2021
Graphic representation:

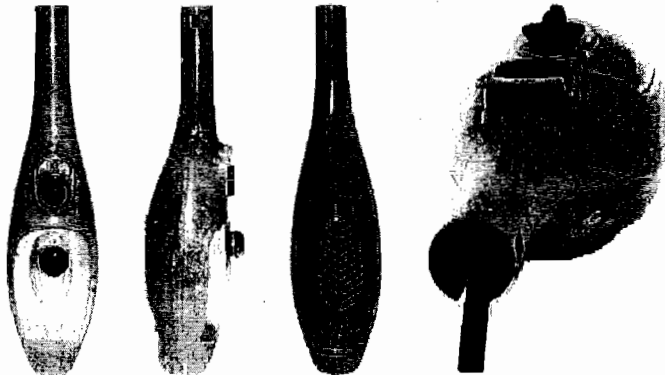

**Patents and Design Registrations and Applications
Held by Thane International, Inc., Thane Direct Company
and/or Thane Direct Canada Inc.
As of October 12, 2015**

- 5. Registration Nr.:** AU 336004 S
Design Nr.: 20111166
Thane reference: H2O Mop X5
Date Lodged: March 18, 2011
Date Registered: April 13, 2011
Classification: 15:05
Article/Product Name: Floor cleaning device
Status: Certified (May 17, 2012)
Renewed to date: March 18, 2016
End of registration period: March 18, 2021
Graphic representation:

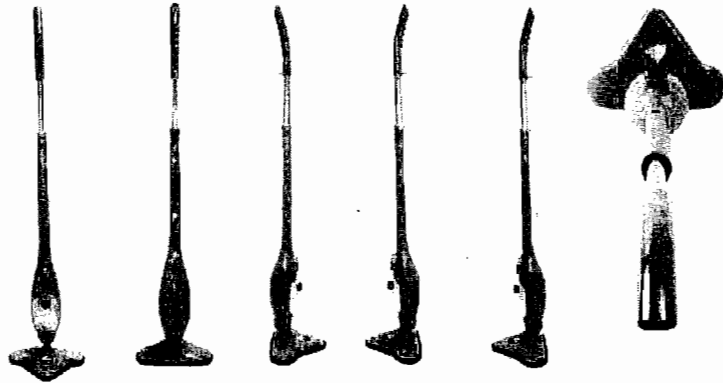

- 6. Registration Nr.:** AU 340778 S
Design Nr.: 201210146
Thane reference: Total Flex
Date Lodged: January 13, 2012
Date Registered: February 2, 2012
Classification: 21-02F
Article/Product Name: Exercise apparatus
Status: Renewed to January 13, 2017
End of registration period: January 13, 2022
Graphic representation:

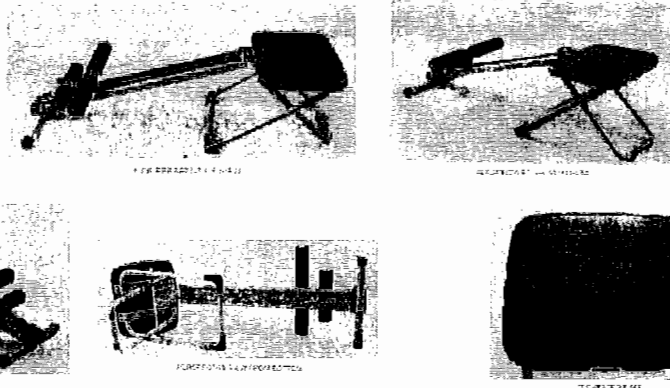

**Patents and Design Registrations and Applications
Held by Thane International, Inc., Thane Direct Company
and/or Thane Direct Canada Inc.
As of October 12, 2015**

- 7. Registration Nr.:** AU 360761 S
Design Nr.: 201510166
Thane reference: H2O PowerX
Date Lodged: January 14, 2015
Date Registered: March 19, 2015
Classification: 15:05
Article/Product Name: Cleaner
Renewed to date: January 14, 2020
End of registration period: January 14, 2025
Graphic representation:

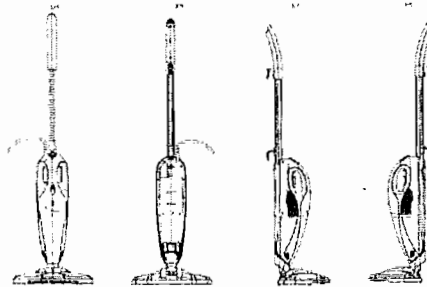

- 8. Registration Nr.:** AU 360762 S
Design Nr.: 201510170
Thane reference: H2O PowerX
Date Lodged: January 14, 2015
Date Registered: March 19, 2015
Classification: 15:05
Article/Product Name: Cleaner
Renewed to date: January 14, 2020
End of registration period: January 14, 2025
Graphic representation:

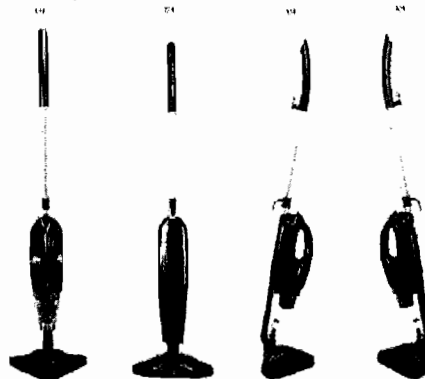

**Patents and Design Registrations and Applications
Held by Thane International, Inc., Thane Direct Company
and/or Thane Direct Canada Inc.
As of October 12, 2015**

9. Registration Nr.: AU 360747 S
Design Nr.: 201510175
Thane reference: H2O PowerX (with triangular head)
Date Lodged: January 14, 2015
Date Registered: March 19, 2015
Classification: 15:05
Article/Product Name: Cleaner
Renewed to date: January 14, 2020
End of registration period: January 14, 2025
Graphic representation:

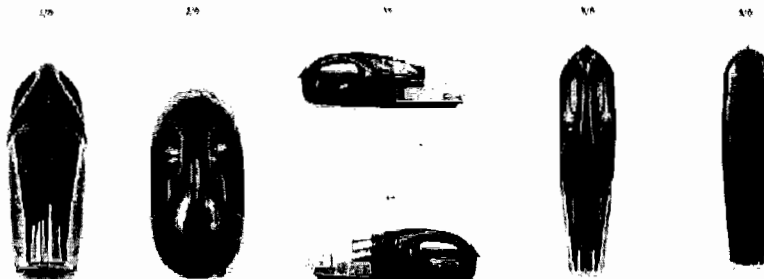

10. Registration Nr.: AU 360763 S
Design Nr.: 201510171
Thane reference: H2O PowerX
Date Lodged: January 14, 2015
Date Registered: March 19, 2015
Classification: 15:05
Article/Product Name: Cleaner compound
Renewed to date: January 14, 2020
End of registration period: January 14, 2025
Graphic representation:

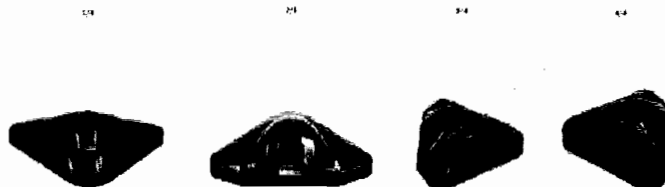

**Patents and Design Registrations and Applications
Held by Thane International, Inc., Thane Direct Company
and/or Thane Direct Canada Inc.
As of October 12, 2015**

11. Registration Nr.: AU 3607648 S
Design Nr.: 201510176
Thane reference: H2O HD
Date Lodged: January 14, 2015
Date Registered: March 19, 2015
Classification: 15:05
Article/Product Name: Steam mop
Renewed to date: January 14, 2020
End of registration period: January 14, 2025
Graphic representation:

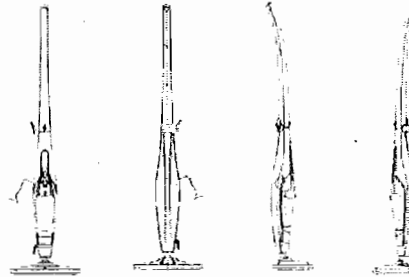

12. Registration Nr.: AU 360750 S
Design Nr.: 201510186
Thane reference: H2O HD
Date Lodged: January 14, 2015
Date Registered: March 19, 2015
Classification: 15:05
Article/Product Name: Steam cleaner
Renewed to date: January 14, 2020
End of registration period: January 14, 2025
Graphic representation:

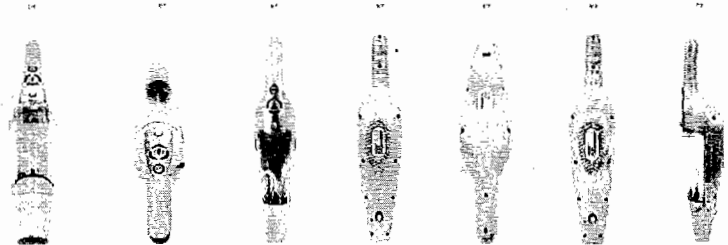

Patents and Design Registrations and Applications
Held by Thane International, Inc., Thane Direct Company
and/or Thane Direct Canada Inc.
As of October 12, 2015

13. Registration Nr.: Pending.
Design Nr.: Unavailable at this time.
Thane reference: H2O PowerX (with rectangular head)
Date Lodged: October 1, 2015
Date Registered: Pending.
Classification: 15:05
Article/Product Name: Head for a steam mop
Renewed to date: Unavailable at this time.
End of registration period: Unavailable at this time.
Graphic representation:

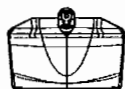

FIG 1

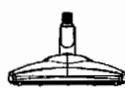

FIG 2

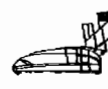

FIG 3



FIG 4

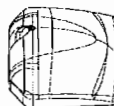

FIG 5



FIG 6



FIG 7

14. Registration Nr.: Pending.
Design Nr.: Unavailable at this time.
Thane reference: H2O PowerX (with rectangular head)
Date Lodged: October 1, 2015
Date Registered: Pending.
Classification: 15:05
Article/Product Name: Head for a steam mop
Renewed to date: Unavailable at this time.
End of registration period: Unavailable at this time.
Graphic representation:



FIG 10



FIG 11

Patents and Design Registrations and Applications
Held by Thane International, Inc., Thane Direct Company
and/or Thane Direct Canada Inc.
As of October 12, 2015

CANADA Industrial Designs

Thane Direct Company

1. Registration Nr.: 120576
Title: Elliptical stationary exercise device
Thane reference: Orbitrek
Date Registered: March 6, 2008
Graphic representation:

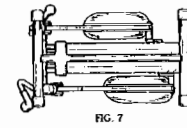
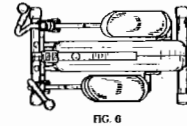
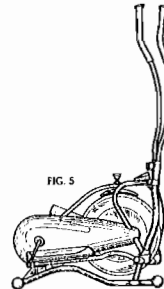
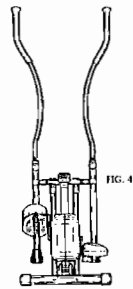
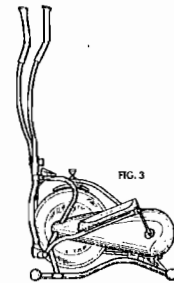
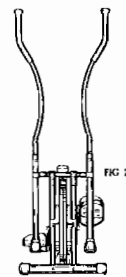
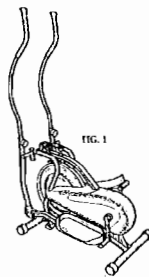

Patents and Design Registrations and Applications
Held by Thane International, Inc., Thane Direct Company
and/or Thane Direct Canada Inc.
As of October 12, 2015

Thane International, Inc.

1. Registration Nr.: 140140
Title: Steamer
Thane reference: H2O Mop X5
Date Registered: January 31, 2012
Graphic representation:

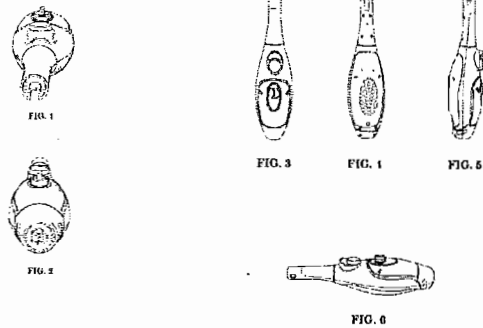

2. Registration Nr.: 138980
Title: Steamer
Thane reference: H2O Mop X5
Date Registered: January 31, 2012
Graphic representation:

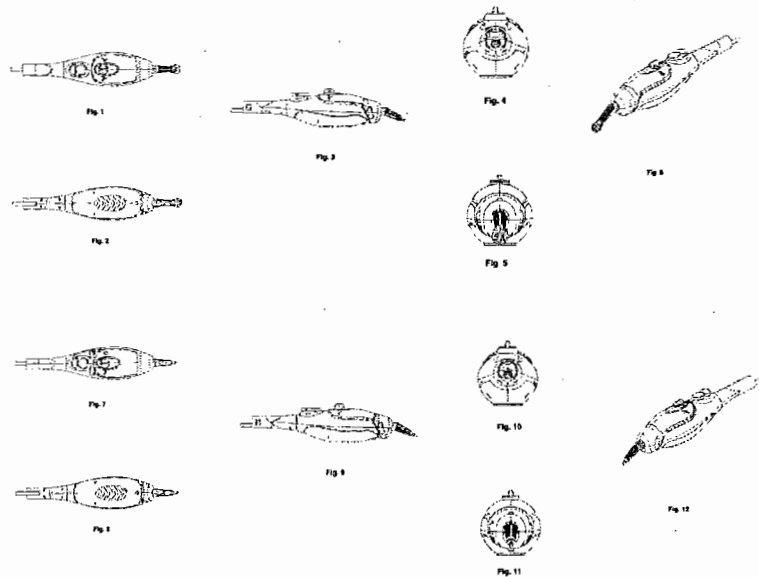

**Patents and Design Registrations and Applications
Held by Thane International, Inc., Thane Direct Company
and/or Thane Direct Canada Inc.
As of October 12, 2015**

- 3. Registration Nr.: 138979**
Title: Mop
Thane reference: H2O Mop X5
Date Registered: January 31, 2012
Graphic representation:



Fig. 1

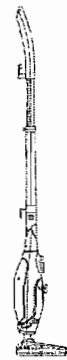

Fig. 2



Fig. 3



Fig. 4



Fig. 5



Fig. 6

- 4. Registration Nr.: 140140**
Title: Steamer
Thane reference: H2O Mop X5
Date Registered: January 31, 2012
Graphic representation:



FIG. 1



FIG. 2



FIG. 3



FIG. 4



FIG. 5



FIG. 6

Patents and Design Registrations and Applications
Held by Thane International, Inc., Thane Direct Company
and/or Thane Direct Canada Inc.
As of October 12, 2015

JAPAN Designs

Thane Direct Company

1. **Reg. Nr.** **1310960**
Thane reference: **SLIM'N LIFT SUPREME**
Appl. Nr. **2007-5091**
Filing date: **February 28, 2007**
Registration date: **August 24, 2007**
Graphic representation:

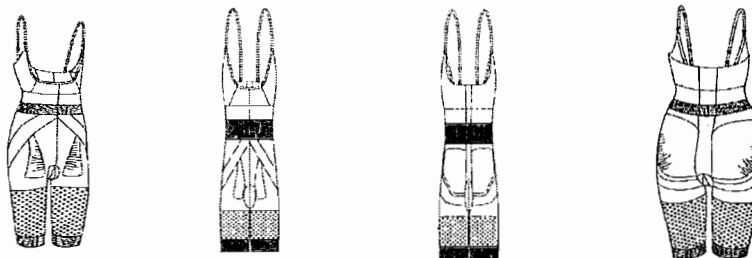

2. **Reg. Nr.** **1435704**
Thane reference: **AB DOER TWIST**
Appl. Nr. **2010-005057**
Filing date: **March 3, 2010**
Registration date: **February 10, 2012**
Graphic representation:

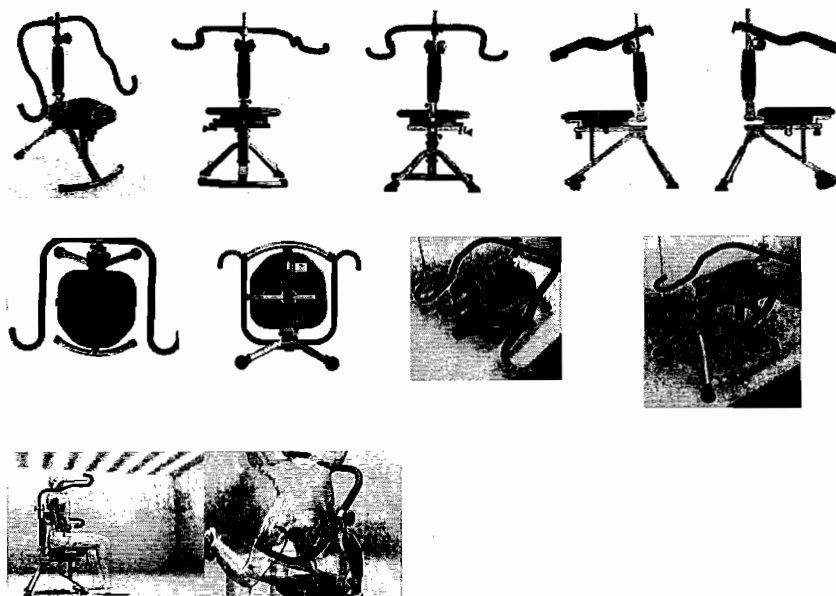

Trademark Registrations and Applications
Held by Thane International, Inc., Thane Direct Company and/or
Thane Direct Canada Inc.
As of October 12, 2015

U.S. Trademarks

• **Thane International, Inc.**

	Mark	Serial Nr.	Reg. Nr.
1	... BEYOND SHAPEWEAR	86013772	4561409
2	3 MINUTE LEGS	77612343	3786387
3	3 MINUTE LEGS	77660240	3747696
4	3ML TOTAL TRANSFORMATIONS	77714243	3747745
5	AB COMMAND	85735018	4580773
6	AB DOER TWIST (figurative)	77679149	3765095
7	AB-DOER	75395129	2654616
8	AGELESS WONDER	85258177	4339184
9	AQUA-FORCE TECHNOLOGY	77360110	3528879
10	CALIFORNIA BEAUTY (Cl. 03)	75421582	2282132
11	CALIFORNIA BEAUTY (Cl. 25)	77225349	3529835
12	CB (figurative) (Cl. 03)	77245826	3884648
13	CB (figurative) (Cl. 25)	85087714	3930963
14	COOLFLEX	85030670	3935836
15	COPPERX (figurative)	86681119	
16	CROSSX2	86499830	
17	DERMA SETA	77655630	3868134
18	DERMA SETA (figurative)	85099821	3931140
19	DualBlast	86753278	
20	FLABBY TO FIT	85644067	4275669
21	FLATTER FORM	86746823	
22	FLAVORCHEF	85662117	4556492
23	FLAVORFRESH	85900327	4769168
24	FLAVORFULL	85929072	4804491
25	FLAVORGOURMET	86616796	
26	FLAVORMASTER	86316327	
27	FLAVORQUIK	85857862	4804456
28	FLAVORSTONE	85287138	4140195
29	FLAVORSTONE INFUSIONGRILL	86607692	
30	FUSIONGRILL	86583285	
31	FLAVORWAVE OVEN	76221469	2560401
32	FLAVORWAVE OVEN TURBO (figurative)	77431069	3501777
33	H2O	85775087	4381334
34	H2O HD	86680693	
35	H2O M O (figurative)	77197298	3378030

**Trademark Registrations and Applications
Held by Thane International, Inc., Thane Direct Company and/or
Thane Direct Canada Inc.
As of October 12, 2015**

	Mark	Serial Nr.	Reg. Nr.
36	H2O M O MOP STEAM CLEANER (figurative)	77340337	3500022
37	H2O MOP	77197286	3425675
38	H2O MOP ULTRA	77815350	3780607
39	H2O MOP ULTRA (figurative)	77445152	3648522
40	(H2O Mop Ultra trade dress)	77576084	3797752
41	H2O MOP X5 (figurative)	85168642	4007640
42	(H2O Mop X5 trade dress)	85302088	4068858
43	H2O STEAMFX	85762070	4566701
44	H2O V O (figurative)	77217386	3378365
45	H2O VAC	77217373	3378364
46	(H2O Vac trade dress)	77577756	3801292
47	H2O X5	85449956	4157759
48	INSTANT SHAPE, FOREVER SMOOTH	86014164	4557437
49	IX2	86317057	
50	JEGEEZE	86754358	
51	LOOK FLAWLESS NOT FAKE	78909524	3300051
52	MAKING FITNESS FUN!	75621110	2439148
53	MOLD N HOLD	85555050	4243665
54	PLAY THE GUITAR OVERNIGHT	74022161	1653314
55	POWERX	86339396	4740892
56	RED FUSION	85496107	4219520
57	REVEAL YOUR TRUE BEAUTY	78909545	3346182
58	ROBOPAL	86361948	
59	ROCKIN' ABS	78736836	3326756
60	SILHOUETTE SLIM 'N LIFT (figurative)	77402789	3504993
61	SLEEPSLIM	85938883	
62	SLIM 'N LIFT	78540176	3339260
63	SLIM 'N LIFT AIRE	85814156	4335037
64	SLIM 'N LIFT AIRE (figurative)	85171994	4007648
65	SLIM 'N LIFT CARESSE	85679510	4498843
66	SLIM 'N LIFT INFUSED	85819922	4544417
67	SLIM 'N LIFT PERFECT FIT	86701379	
68	SLIM 'N LIFT SHEER SECRET	85706838	4515466
69	SLIM 'N LIFT SUPREME COMFORT	77416621	3548115
70	SLIM 'N LIFT SUPREME COMFORT (figurative)	77420321	3548123
71	SLIMFIT	86745936	
72	STEAM LAZER	85470648	4255143
73	SWIRL GLIDE AND GLOW	78909531	3300052

Trademark Registrations and Applications
Held by Thane International, Inc., Thane Direct Company and/or
Thane Direct Canada Inc.
As of October 12, 2015

	Mark	Serial Nr.	Reg. Nr.
74	THANE	77484517	3543606
75	(Thane figurative)	76322949	2773051
76	THANE (rebrand figurative)	86104490	8614490
77	THANE FITNESS	76334099	2731346
78	THANE H2O HD (figurative)	86547048	4808546
79	THUNDERSTICK	85241549	4440568
80	THUNDER STICK (figurative)	77414802	3526986
81	TRUE COVER	78824246	3304403
82	TRUE COVER'S GOT IT COVERED	78909536	3327850
83	TRUE COVER SETS YOU FREE	78909549	3346183
84	TRUE SLEEP	76473117	2912071
85	TRUE SLEEPER	78175632	3285450
86	TOTAL FLEX	77907125	3962819
87	TOTAL FLEX (figurative)	85343404	4063472
88	TOTAL VIBES	77419950	3702517
89	TOTALTONE	86057031	

Trademark Registrations and Applications
Held by Thane International, Inc., Thane Direct Company and/or
Thane Direct Canada Inc.
As of October 12, 2015

CANADA Trademarks

• **Thane International, Inc.**

	Mark	Appl. Nr.	Reg. Nr.
1	. . .BEYOND SHAPEWEAR	1636079	TMA 890334
2	3 MINUTE LEGS	1417912	TMA779862
3	3 MINUTE LEGS (figurative)	1426322	TMA766927
4	AB COMMAND	1690558	
5	AB DOER TWIST (figurative)	1512920	TMA817338
6	(circle segment design)	1203185	TMA637849
7	CALIFORNIA BEAUTY (Cl. 03)	1107273	TMA616263
8	CALIFORNIA BEAUTY (Cl. 25)	1517837	TMA816386
9	COMMAND COLLAR	1398198	TMA959948
10	COPPERX (figurative)	1735359	
11	CROSSX2	1710222	
12	DERMA SETA	1425508	TMA772638
13	DERMA SETA (figurative)	1492012	TMA799112
14	DualBlast	1745533	
15	FLATTER FORM	1744665	
16	FLAVORCHEF	1608379	TMA877503
17	FLAVORFULL	1649836	
18	FLAVORFRESH	1622027	TMA909714
19	FLAVORGOURMET	1726477	
20	FLAVORGRILL	1721865	
21	FLAVORMASTER	1682267	
22	FLAVORQUIK	1615411	
23	FLAVORSTONE	1522428	TMA821611
24	FLAVORSTONE INFUSIONGRILL	1725229	
25	FLAVORWAVE OVEN	1313510	TMA706879
26	FLAVORWAVE OVEN TURBO (figurative)	1390646	TMA780067
27	FUSIONGRILL	1721956	
28	H2O	1601675	TMA864085
29	H2O HD	1744060	
30	H2O MO (figurative)	1368100	TMA739153
31	H2O MOP	1368101	TMA738335
32	H2O MOP STEAM CLEANER (figurative)	1375642	TMA738362
33	H2O MOP ULTRA (figurative)	1390909	TMA757968
34	H2O MOP X5 (figurative)	1502538	TMA818996
35	H2O STEAMFX	1627830	TMA883695

Trademark Registrations and Applications
Held by Thane International, Inc., Thane Direct Company and/or
Thane Direct Canada Inc.
As of October 12, 2015

	Mark	Appl. Nr.	Reg. Nr.
36	H2O VAC	1373849	TMA743696
37	H2O X5	1548459	TMA834382
38	INSTANT SHAPE, FOREVER SMOOTH	1635834	TMA893235
39	IX2	1682363	
40	JEGEEZE	1745715	
41	MIGHTY	1624208	
42	ORBITREK	1356045	TMA730814
43	POWERX	1711062	
44	KLEAR ACTIV	1213676	TMA644028
45	KLEAR ACTIV	1252448	TMA694990
46	Q	1186091	TMA636201
47	ROBOPAL	1713572	
48	ROCKIN' ABS	1524835	TMA822592
49	SLIM'N LIFT	1243569	TMA665756
50	SLIM 'N LIFT AIRE (figurative)	1504471	TMA807037
51	SLIM 'N LIFT CARESSE	1586555	TMA895661
52	SLIM 'N LIFT INFUSED	1609403	
53	SLIM 'N LIFT PERFECT FIT	1738536	
54	SLIM 'N LIFT SUPREME COMFORT (figurative)	1387139	TMA797864
55	SLIMFIT	1744492	
56	STEAM LAZER	1575263	TMA854900
57	SWIVEL SWEEPER	1285099	TMA682870
58	THANE	1109813	TMA617906
59	THANE (rebrand figurative)	1647377	TMA901105
60	THANE FITNESS	1107274	TMA604623
61	THE DOGFATHER	1398195	TMA759944
62	THUNDERSTICK	1515219	TMA815413
63	TOTAL FLEX	1464998	TMA799860
64	TOTAL FLEX (figurative)	1533154	TMA827,233
65	V O H2O (figurative)	1305493	TMA691294
66	V H2O TURBO (figurative)	1373851	TMA739496
67	VAC ATTACK	1636040	

Trademark Registrations and Applications
Held by Thane International, Inc., Thane Direct Company and/or
Thane Direct Canada Inc.
As of October 12, 2015

COMMUNITY Trademarks* ("CTM")

• **Thane International, Inc.**

	Mark	Trademark Nr.	Status
1	AGELESS WONDERS	002177517	Registered
2	AUS DER TV WERBUNG (figurative)	010522456	Registered
3	CALIFORNIA BEAUTY	002177699	Registered
4	SLIM 'N LIFT (figurative)	009979766	Registered
5	SWIVEL SWEEPER	004517447	Registered
6	SWIVEL SWEEPER (figurative)	005336128	Registered
7	SWIVEL SWEEPER (figurative)	005336111	Registered
8	THANE	002295327	Registered
9	THANE FITNESSS	002177327	Registered
10	THE DOGFATHER (figurative)	007071343	Registered

*See also, International Registrations ("IR") / Madrid Trademarks section below.

• **Thane Direct Company**

	Mark	Trademark Nr.	Status
1	9 MINUTE MARINATOR	006812382	Registered
2	9 MINUTE MARINATOR (figurative)	005754759	Registered
3	CALIFORNIA BEAUTY	005959201	Registered
4	H2O M O (figurative)	006379911	Registered
5	H2O MOP	006379581	Registered
6	MINUTE MARINATOR	005773221	Registered
7	SLIM 'N LIFT	05380134	Registered
8	SUDDEN GLOW	005380159	Registered
9	THANE FITNESS	006074017	Registered
10	TRUE COVER	005380167	Registered

• **Thane Direct Canada Inc.**

	Mark	Trademark Nr.	Status
1	KLEAR ACTIV	003763471	Registered

Trademark Registrations and Applications
Held by Thane International, Inc., Thane Direct Company and/or
Thane Direct Canada Inc.
As of October 12, 2015

Foreign National Trademark Registrations/Applications
(filed directly with the subject country's Trademark Office):

Albania*

Thane International, Inc.

*See International Trademarks section below.

Australia*

Thane Direct Company

	Mark	Trademark Nr.	Status
1	BODY VIBES	1218154	Registered

Thane International, Inc.

	Mark	Trademark Nr.	Status
1	TRONIC	1494627	Registered

*See also, International/Madrid Trademarks section below.

Benelux*

Thane Direct Company

	Mark	Trademark Nr.	Status
1	SLIM 'N LIFT (figurative)	0819651	Registered

Thane International, Inc.

	Mark	Trademark Nr.	Status
1	FLAVORWAVE OVEN	0855499	Registered
2	FLAVORWAVE OVEN TURBO (figurative)	0855530	Registered

*See International/Madrid Trademarks section below.

Bosnia*

Thane International, Inc.

*See International Trademarks section below.

Trademark Registrations and Applications
Held by Thane International, Inc., Thane Direct Company and/or
Thane Direct Canada Inc.
As of October 12, 2015

Brazil**Thane International, Inc.**

	Mark	Trademark Nr.	Status
1	DERMA SETA	Appl. Nr. 831295970	Filed
2	FLAVORMASTER	Appl. Nr. 909299293	Filed
3	FLAVORSTONE (word & design, Cl. 21)	Appl. Nr. 840554737	Filed
4	FLAVORSTONE (word, Cl. 08)	Appl. Nr. 909299048	Filed
5	FLAVORSTONE (word, Cl. 21)	Appl. Nr. 909299188	Filed
6	FLAVORWAVE OVEN	Reg. Nr. 830167609	Registered
7	H2O MOP	Appl. Nr. 230805513951	Filed
8	H2O X5	Appl. Nr. 831284358	Filed
9	ORBITREK	Reg. Nr. 822933721	Registered
10	ROCKIN' ABS (word & design)	Appl. Nr. 831020547	Filed
11	SLIM 'N LIFT (word & design)	Reg. Nr. 829950680	Registered
12	SWIVEL SWEEPER (word & design)	Reg. Nr. 829950664	Registered
13	THANE FLAVORMASTER (word & design)	Appl. Nr. 909299374	Filed
14	TOBI (word & design)	Reg. Nr. 830624139	Registered

Chile**Thane International, Inc.**

	Mark	Trademark Nr.	Status
1	SLIM 'N LIFT	Reg. Nr. 907,068	Registered
2	ORBITREK	Reg. Nr. 1170242	Registered

China***Thane International, Inc.**

	Mark	Trademark Nr.	Status
1	AB-DOER	Reg. Nr. 3113863	Registered
2	TRUE SLEEPER (figurative, Class 20)	Reg. Nr. 12343094	Registered

*See also, International/Madrid Trademarks section below.

Costa Rica**Thane International, Inc.**

	Mark	Trademark Nr.	Status
1	ORBITREK (figurative)	Reg. Nr. 164745	Registered

Trademark Registrations and Applications
Held by Thane International, Inc., Thane Direct Company and/or
Thane Direct Canada Inc.
As of October 12, 2015

Croatia*

Thane International, Inc.

*See International Trademarks section below.

Czech Republic

Thane International, Inc.

	Mark	Trademark Nr.	Status
1	THANE	Reg. Nr. 252364	Registered

Ecuador

Thane Direct Company

	Mark	Trademark Nr.	Status
1	ORBITREK	Reg. Nr. 169280	Registered

Thane International, Inc.

	Mark	Trademark Nr.	Status
1	FLAVORWAVE OVEN	Reg. Nr. 39107	Registered
2	FLAVORWAVE OVEN TURBO (figurative)	Reg. Nr. 39106	Registered

El Salvador

Thane International, Inc.

	Mark	Trademark Nr.	Status
1	ORBITREK (figurative)	Reg. Nr. 00104 L.00082	Registered

Germany

Thane Direct Company

	Mark	Trademark Nr.	Status
1	SUDDEN GLOW	Reg. Nr. DE 30661519	Registered

Thane International, Inc.

	Mark	Trademark Nr.	Status
1	AB-DOer	Reg. Nr. DE 300627238	Registered
2	ORBITREK (figurative)	Reg. Nr. DE 399587128	Registered
3	SLIM'N LIFT	Reg. Nr. DE 306615207	Registered

*See also, International Trademarks section below.

Trademark Registrations and Applications
Held by Thane International, Inc., Thane Direct Company and/or
Thane Direct Canada Inc.
As of October 12, 2015

Guatemala**Thane International, Inc.**

	Mark	Trademark Nr.	Status
1	ORBITREK (figurative)	Reg. Nr. 151,560	Registered

Hong Kong**Thane International, Inc.**

	Mark	Trademark Nr.	Status
1	BODY VIBES	Reg. Nr. 2000B10592	Registered

India***Thane International, Inc.**

	Mark	Trademark Nr.	Status
1	AB DOER	Appl. Nr. 2147284	Filed
2	AB DOER TWIST (figurative)	Appl. Nr. 2147286	Filed
3	FLAVORWAVE OVEN,	Appl. Nr. 2147281	Filed
4	FLAVORWAVE OVEN (figurative)	Appl. Nr. 2147282	Filed
5	H2O MOP	Appl. Nr. 2147283	Filed
6	H2O MOP X5 (figurative)	Appl. Nr. 2147280	Filed
7	ORBITREK	Appl. Nr. 2132829	Filed
8	ORBITREK ELITE (figurative)	Appl. Nr. 2132827	Filed
9	ORBITREK PLATINUM	Appl. Nr. 2132828	Filed
10	SLIM 'N LIFT	Appl. Nr. 2147285	Filed
11	SLIM 'N LIFT AIRE BRA	Appl. Nr. 2388560	Filed
12	SLIM 'N LIFT AIRE BRA (figurative)	Appl. Nr. 2388561	Filed
13	TRUE SLEEPER	Appl. Nr. 2314098	Filed

*See also, International Trademarks section below.

Trademark Registrations and Applications
Held by Thane International, Inc., Thane Direct Company and/or
Thane Direct Canada Inc.
As of October 12, 2015

Indonesia**Thane International, Inc.**

	Mark	Trademark Nr.	Status
1	FLAVORFULL	Appl. Nr. D00 2013 051899	Filed
2	FLAVORMASTER	Appl. Nr. D00 2014 058939	Filed
3	H2O (Cl. 07)	Appl. Nr. D00 2013-021682	Filed
4	H2O (Cl. 11)	Appl. Nr. D00 2013-021682	Filed
5	H2O X5	Appl. Nr. D00 2013-028531	Filed
6	H2O X5(figurative)	Appl. Nr. D00 2013-028530	Filed
7	THANE (rebrand figurative)	Appl. Nr. D00 2014 006782	Filed
8	TOBI (figurative)	Appl. Nr. D00 2013-035069	Filed

Japan***Thane Direct Company**

	Mark	Trademark Nr.	Status
1	SWIVEL SWEEPER	Reg. Nr. 5078868	Registered
2	SWIVEL SWEEPER (figurative)	Reg. Nr. 5269499	Registered
3	SWIVEL SWEEPER (figurative)	Reg. Nr. 5269500	Registered
4	SWIVEL SWEEPER (in Japanese Katakana characters)	Reg. Nr. 5078868	Registered

Thane International, Inc.

	Mark	Trademark Nr.	Status
1	AB DOER	Reg. Nr. 5519616	Registered
2	AB DOER TWIST + Katakana	Reg. Nr. 5519617	Registered
3	CALIFORNIA BEAUTY + Katakana	Reg. Nr. 5081503	Registered
4	SHEER SECRET (in Japanese Katakana characters)**	Reg. Nr. 5580078	Registered
5	SLIM 'N LIFT	Reg. Nr. 4898243	Registered

*See also, International Trademarks section below.

**Assigned to Thane International, Inc. by its distributor in Japan.

Jordan**Thane Direct Company**

	Mark	Trademark Nr.	Status
1	ORBITREK	Reg. Nr. 93353	Registered

Kuwait**Thane International, Inc.**

	Mark	Trademark Nr.	Status
1	THANE (figurative)	Reg. Nr. 56267	Registered

Trademark Registrations and Applications
Held by Thane International, Inc., Thane Direct Company and/or
Thane Direct Canada Inc.
As of October 12, 2015

Lebanon**Thane International, Inc.**

	Mark	Trademark Nr.	Status
1	FLAVORWAVE OVEN	Reg. Nr. 138301	Registered
2	FLAVORWAVE OVEN EXPRESS (figurative)	Reg. Nr.138302	Registered
3	H2O MOP	Reg. Nr. 144414	Registered
4	H2O MOP X5 (figurative)	Reg. Nr. 144413	Registered
5	RELAX & TONE	Reg. Nr. 137356	Registered
6	SLIM 'N LIFT	Reg. Nr. 154227	Registered

Macedonia***Thane International, Inc.**

*See International Trademarks section below.

Mexico***Thane Direct Company**

	Mark	Trademark Nr.	Status
1	AB-DOER	Reg. Nr. 1180225	Registered
2	AB-DOER TWIST (figurative)	Reg. Nr. 1238392	Registered
3	DERMA SET	Reg. Nr. 1163594	Registered
4	FLAVORWAVE (figurative)	Reg. Nr. 1076586	Registered
5	FLAVORWAVE OVEN	Reg. Nr. 1137265	Registered
6	FLAVORWAVE OVEN TURBO (figurative)	Reg. Nr. 1140240	Registered
7	ORBITREK (figurative)	Reg. Nr. 975195	Registered
8	TOBI (Class 07)	Reg. Nr. 1126433	Registered
9	TOBI (Class 09)	Reg. Nr. 1188623	Registered
10	ORBITREK		Filed

Mexico trademarks held by Thane International, Inc. are found on the next page.

Trademark Registrations and Applications
Held by Thane International, Inc., Thane Direct Company and/or
Thane Direct Canada Inc.
As of October 12, 2015

Mexico***Thane International, Inc.**

	Mark	Trademark Nr.	Status
1	DERMA SETA	Reg. Nr. 1243836	Registered
2	DERMA SETA (figurative)	Reg. Nr. 1243837	Registered
3	FLAVORCHEF	Reg. Nr. 1368892	Registered
4	FLAVORSTICK	Reg. Nr. 1193840	Registered
5	FLAVORSTONE	Reg. Nr. 1238263	Registered
6	FLOW FORM	Reg. Nr. 1340276	Registered
7	MEJOR COMPRA TV	Reg. Nr. 1282123	Registered
8	MEJOR COMPRA TV (figurative)	Reg. Nr. 1195039	Registered
9	NANO GYM	Reg. Nr. 1315857	Registered
10	RED FUSION	Reg. Nr. 1325177	Registered
11	SILHOUETTE SLIM N LIFT SUPREME	Reg. Nr. 1215406	Registered
12	SILHOUETTE SLIM N LIFT SUPREME (figurative)	Reg. Nr. 1210984	Registered
13	SLIM LIFT SUPREME	Reg. Nr. 1007331	Registered
14	SLIM 'N LIFT CARESSE	Reg. Nr. 1430141	Registered
15	STEELABS	Reg. Nr. 124604	Registered
16	STEAM LAZER	Reg. Nr. 1315251	Registered
17	TOTAL FLEX	Reg. Nr. 1195069	Registered
18	TOTAL FLEX (figurative)	Reg. Nr. 1257871	Registered
19	URBAN SECRET	Reg. Nr. 1317404	Registered

*See International Trademarks section below.

Moldova***Thane International, Inc.**

*See International Trademarks section below.

Montenegro***Thane International, Inc.**

*See International Trademarks section below.

New Zealand***Thane International, Inc.**

	Mark	Trademark Nr.	Status
1	AB DOER TWIST	840883	Registered
2	H2O (figurative)	834996	Registered
3	TOBI	794149	Registered

*See also, International Trademarks section below.

Trademark Registrations and Applications
Held by Thane International, Inc., Thane Direct Company and/or
Thane Direct Canada Inc.
As of October 12, 2015

Norway*

Thane International, Inc.

*See International Trademarks section below.

Peru

Thane International, Inc.

	Mark	Trademark Nr.	Status
1	TOTAL FLEX*	Appl. Nr. 2014-587507	Filed

*Assigned to Thane International, Inc. from a distributor.

Qatar

Thane International, Inc.

	Mark	Trademark Nr.	Status
1	H2O MOP	Reg. Nr. 75971	Registered
2	H2O MOP X5 (figurative)	Reg. Nr. 75972	Registered

Saudi Arabia

Thane International, Inc.

	Mark	Trademark Nr.	Status
1	H2OMOP X5	Reg. Nr. 193182	Registered

Serbia*

Thane International, Inc.

*See International Trademarks section below.

South Korea*

Thane International, Inc.

*See International Trademarks section below.

Spain

Thane International, Inc.

	Mark	Trademark Nr.	Status
1	ORBITREK	Reg. Nr. 2224842	Registered

Trademark Registrations and Applications
Held by Thane International, Inc., Thane Direct Company and/or
Thane Direct Canada Inc.
As of October 12, 2015

Switzerland***Thane Direct Company**

	Mark	Trademark Nr.	Status
1	ORBITREK	Reg. Nr. 584264	Registered

Thane International, Inc.

	Mark	Trademark Nr.	Status
1	AUS DER TV WERBUNG (figurative)	Reg. Nr. 010522456	Registered

*See also, International Trademarks section below.

Taiwan**Thane International, Inc.**

	Mark	Trademark Nr.	Status
1	ORBITREK	Reg. Nr. 2224842	Registered

Turkey***Thane International, Inc.**

	Mark	Trademark Nr.	Status
1	H2O	Grant Nr. 2007 37113	Registered
2	H2O MOP X5	Reg. Nr. 2011/40318	Registered
3	SLIM 'N LIFT AIRE	Reg. Nr. 2011/40464	Registered
4	SLIM 'N LIFT SILHOUETTE SUPREME (figurative)	Grant Nr. 2006/57291	Registered

*See also, International Trademarks section below.

U.A.E.**Thane International, Inc.**

	Mark	Trademark Nr.	Status
1	H2O MOP	Reg. Nr. 174071	Registered
2	H2O MOP X5	Reg. Nr. 174070	Registered
3	TÉ CHINO DEL DR. MING	Appl Nr. 180120	Filed

Trademark Registrations and Applications
Held by Thane International, Inc., Thane Direct Company and/or
Thane Direct Canada Inc.
As of October 12, 2015

U.K.***Thane Direct Company**

	Mark	Trademark Nr.	Status
1	OM H2O (figurative)	Reg. Nr. 2469947	Registered
2	H2O MOP	Reg. Nr. 2470005	Registered
3	SLIM'N LIFT, (Cl. 9 and 41)	Reg. Nr. 2441612	Registered
4	SUDDEN GLOW	Reg. Nr. 2441610	Registered
5	SWIVEL SWEEPER (figurative)	Reg. Nr. 2417363A	Registered
6	SWIVEL SWEEPER (figurative)	Reg. Nr. 2417363B	Registered
7	TRUE COVER	Reg. Nr. 2441142	Registered

*See also, International Trademarks section below.

Ukraine***Thane International, Inc.**

*See International Trademarks section below.

Vietnam***Thane International, Inc.**

	Mark	Trademark Nr.	Status
1	ORBITREK	Reg. Nr. 172502	Registered
2	TOBI	Reg. Nr. 159590	Registered
3	TOBI (figurative)	Reg. Nr. 159591	Registered

*See also, International Trademarks section below.

Trademark Registrations and Applications
Held by Thane International, Inc., Thane Direct Company and/or
Thane Direct Canada Inc.
As of October 12, 2015

International Trademarks (listed below numerically, in ascending order)
(Various International Trademark Registrations ("IR") / Applications filed in a single application designating separate countries, through the Madrid Protocol process).

• **Thane International, Inc.**

	Mark	IR	Designated Countries & Status of Grant of Protection ("GOP" under IR)
1	SLIM 'N LIFT	0954555	Australia: Protected as Australia TM 1230702. Vietnam: <i>Refused; response filed.</i>
2	H2O MOP	0954756	Australia: Protected as Australia TM 1230756. China: Refusal period has expired; protected as Reg. Nr. G954756. Germany: Protected (refusal period has expired). Japan: Protection granted. Vietnam: <i>Refused; response filed.</i> Mexico: Protection granted. EU: Protected (GOP process completed). Switzerland: Protected (refusal period has expired).
3	H2O VAC	0954757	Australia: Protected as Australia TM#1230757. China: Refusal period has expired; protected as Reg. Nr. G954757. U.K.: Protected as U.K. TM #M954757.
4	H2O V O (figurative)	0954973	Australia: Protected as Australia TM 1231536 China: Refusal period has expired; protected as Reg. Nr. G954973. U.K.: Protected as U.K. TM #M954973.
5	H2O M O (figurative)	0955126	Australia: Protected as Australia TM 1231571. Germany: Protected (refusal period has expired).
6	TOTAL VIBES	0958618	Australia: Protected as Australia TM 1237739. China: Protected (refusal period has expired). EU: Protected (GOP process completed). Germany: Protected (refusal period has expired). Japan: Protection granted. U.K.: Protected as U.K. TM #M958618.

Trademark Registrations and Applications
Held by Thane International, Inc., Thane Direct Company and/or
Thane Direct Canada Inc.
As of October 12, 2015

	Mark	IR	Designated Countries & Status of Grant of Protection ("GOP" under IR)	
7	SLIM 'N LIFT SUPREME COMFORT (figurative)	0959293	Australia:	Protected as Australia TM 1239040.
			EU:	Protected (GOP process completed).
			Germany:	Protected (refusal period has expired).
			Japan:	Protection granted.
			U.K.:	Protected as U.K. TM #M959293.
8	H2O MOP ULTRA (figurative)	0960892	Australia:	Protected as Australia TM 1241790.
			China:	Ref. #200810727; protection granted following successful response to refusal; Reg. Nr. G960892.
			EU:	Ref# 44446001; protection granted.
			Germany:	Protected (refusal period has expired).
			Japan:	Protection granted.
			U.K.:	Protected as U.K. TM #M960892.
			<i>Vietnam:</i>	<i>Refused; response filed.</i>
			Albania:	Protected (refusal period has expired).
			Bosnia:	Protection granted.
			Croatia:	Protection granted.
			Macedonia:	Protected (refusal period has expired).
			Moldova:	Protection granted.
			Montenegro:	Protected granted.
			Russia:	Protection granted after initial refusal.
			Serbia:	Protection granted.
			Ukraine:	Protection granted.
			Norway:	Protection granted.
9	SILHOUETTE SLIM 'N LIFT (figurative)	0961978	Australia:	Protected as Australia TM 1243217.
			China:	Refusal period has expired; protected as Reg. No. G961978.
			Germany:	Protected (refusal period has expired).
			Japan:	Protection granted after overcoming opposition.
10	V H2O TURBO (figurative)	0962013	Australia:	Protected as Australia TM #1243225.
			China:	Refusal period has expired; protected as Reg. Nr. G962013.
			EU:	Protected (GOP process completed).
			Germany:	Protected (refusal period has expired).
			Japan:	Protection granted.

Trademark Registrations and Applications
Held by Thane International, Inc., Thane Direct Company and/or
Thane Direct Canada Inc.
As of October 12, 2015

	Mark	IR	Designated Countries & Status of Grant of Protection ("GOP" under IR)	
11	TRUE COVER	0963787	Japan:	Protection granted.
12	THANE FITNESS	0964191	Japan:	Protection granted.
13	(Thane logo)	0970835	China:	Protected as Reg. Nr. G970835.
14	3 MINUTE LEGS	0985917	U.K.:	Protected as U.K. TM #M985917.
			Switzerland:	Protected (refusal period has expired).
15	FLAVORWAVE OVEN	0987308	Australia:	Protected as Australia TM 1279114.
			China:	Refusal period has expired; protected as Reg. Nr. G987308.
			EU:	Protected (GOP process completed).
			Germany:	Protected (GOP process completed).
			Japan:	Protection granted.
			U.K.:	Protected as U.K. TM #M987308.
			Vietnam:	Protected (refusal period has expired).
Norway:	Protection granted.			
16	3 MINUTE LEGS	0988180	Australia:	Protected as Australia TM 1280115.
			EU:	Protected (GOP process completed).
			Germany:	Protected (GOP process completed).
			Japan:	Protection granted.
17	FLAVORWAVE OVEN TURBO (figurative)	0988594	Australia:	Protected as Australia TM 1280894.
			EU:	Protected (GOP process completed).
			Germany:	Protected (refusal period has expired).
			Japan:	Protection granted.
			U.K.:	Protected as U.K. TM #988594.
			Vietnam:	Protected (refusal period has expired).
			Turkey:	Protection granted.
Norway:	Protection granted.			
18	3 MINUTE LEGS (figurative)	0995240	Australia:	Protected as Australia TM 1291273.
			EU:	Protected.
			Germany:	Protected (refusal period has expired).
			Japan:	Protection granted.
			U.K.:	Protected as U.K. TM #M995240.

Trademark Registrations and Applications
Held by Thane International, Inc., Thane Direct Company and/or
Thane Direct Canada Inc.
As of October 12, 2015

	Mark	IR	Designated Countries & Status of Grant of Protection ("GOP" under IR)
19	TRUE SLEEPER	0995757	China: Protected (refusal period has expired). South Korea: Protected granted.
20	AB DOER TWIST (figurative)	0996687	Australia: Protected as Australia TM 1293659. China: Protected granted, following initial refusal. EU: Protected (GOP completed). Germany: Protected (refusal period has expired). Japan: Protection granted, following initial refusal. U.K.: Protected as U.K. TM #M996687. Switzerland: Protected (refusal period has expired). So. Korea: Protection granted, following initial refusal. Norway: Protection granted.
21	H2O MOP ULTRA	1014421	Australia: Protected as Australia TM 1325892. China: Protected (refusal period has expired). EU: Protected (GOP process completed). Germany: Protected (refusal period has expired). Japan: Protection granted. Switzerland: Protected (refusal period has expired). U.K.: Protected as U.K. TM #M1014421. <i>Vietnam: Refused; response filed.</i> Albania: Protected (refusal period has expired). Bosnia: Protection granted. Croatia: Protected (GOP process completed). Macedonia: Protected (refusal period has expired). Montenegro: Protection granted. Serbia: Protection granted. Ukraine: Protection granted.
22	AB-DOER	1019038	Australia: Protected as Australia TM 1334432. Switzerland: Protected (refusal period has expired). U.K.: Protected as UK TM #M1019038. So. Korea: Refused; response filed; protection granted.

Trademark Registrations and Applications
Held by Thane International, Inc., Thane Direct Company and/or
Thane Direct Canada Inc.
As of October 12, 2015

	Mark	IR	Designated Countries & Status of Grant of Protection ("GOP" under IR)	
23	DERMA SETA	1039242	Australia:	Protected as Australia TM 1365954.
			EU:	Protection granted.
			Germany:	Protected (refusal period has expired).
			Japan:	Protection granted.
			Switzerland:	Protection granted.
			Turkey:	Protected as Grant No. 2010/55217.
			U.K.:	Protected as U.K. TM #M1039342.
			Albania:	Protected (refusal period has expired).
			Bosnia:	Protection granted.
			Croatia:	Protected (GOP process completed).
			Macedonia:	Protected (refusal period has expired).
			Moldova:	Protected (GOP process completed).
			Montenegro:	Protection granted.
			Serbia:	Protection granted.
Ukraine:	Protection granted.			
Norway:	Protection granted.			
24	TOTAL FLEX	1045571	Australia:	Protected as Australia TM 1378261.
			EU:	Protected (GOP completed).
			Japan:	Protection granted.
			Russia:	Protected (GOP completed).
			Turkey:	Protected as Grant No. 2010/58417.
			U.K.:	Protected as U.K. TM #M1045571.
			Vietnam:	<i>Refused; response filed.</i>
25	DERMA SETA (figurative)	1054140	Australia:	Protected as Australia TM 1392241.
			EU:	Protection granted.
			Germany:	Protected as DE 85 099 821.
			Japan:	Protection granted.
			Switzerland:	Protection granted.
			Turkey:	Protected as Grant No. 2010/74292.
			U.K.:	Protected as U.K. TM #M1054140.
			Albania:	Protected (refusal period has expired).
			Bosnia:	Protection granted.
			Croatia:	Protection granted.
			Macedonia:	Protected (refusal period has expired).
			Moldova:	Protection granted.
			Montenegro:	Protection granted.
			Serbia:	Protection granted.
Ukraine:	Protection granted.			
Norway:	Protection granted.			

Trademark Registrations and Applications
Held by Thane International, Inc., Thane Direct Company and/or
Thane Direct Canada Inc.
As of October 12, 2015

	Mark	IR	Designated Countries & Status of Grant of Protection ("GOP" under IR)
26	SLIM 'N LIFT AIRE (figurative)	1059408	Australia: Protected as Australia TM 1401189.
			EU: Protection granted.
			Germany: Protected as DE 85 171 994.
			Japan: Protection granted.
			Russia: Protected (consent agreement finalized & entered).
			Switzerland: Protection granted.
			Turkey: Protected as Grant No. 2011/84792.
			U.K.: Protected as U.K. TM #M1059408.
			Norway: Protected (consent agreement finalized & entered).
27	H2O MOP X5 (figurative)	1063367	Australia: Protected as Australia TM 1405459.
			China: Protection granted.
			EU: Protection granted.
			Germany: Protected as DE 85 168 642.
			Japan: Protection granted.
			Russia: Protection granted.
			Switzerland: Protected (refusal period has expired).
			Turkey: Protection granted.
			U.K.: Protected as U.K. TM #M1063367.
			Norway: Protected.
			<i>Vietnam: Refused; response filed.</i>
			Albania: Protected (refusal period has expired).
			Bosnia: Protected (refusal period has expired).
			Croatia: Protected (refusal period has expired).
			Macedonia: Protected (refusal period has expired).
			Moldova: Protection granted.
			Montenegro: Protected (refusal period has expired).
Serbia: Protected (refusal period has expired).			
Ukraine: Protection granted.			

Trademark Registrations and Applications
Held by Thane International, Inc., Thane Direct Company and/or
Thane Direct Canada Inc.
As of October 12, 2015

	Mark	IR	Designated Countries & Status of Grant of Protection ("GOP" under IR)	
28	AGELESS WONDER	1079052	Australia:	Protected as Australia TM 1419684.
			China:	Protection granted.
			EU:	Protection granted.
			Germany:	Protected as DE 85 258 177.
			Japan:	Protection granted.
			Norway:	Protection granted.
			Russia:	Protection granted.
			Switzerland:	Protected (refusal period has expired).
			Turkey:	Protection granted.
U.K.:	Protected as U.K. TM #M1070952.			
29	THUNDERSTICK	1074021	Australia:	Protected as Australia TM 1423407.
			China:	Protection granted.
			EU:	Protection granted.
			Germany:	Protected as DE 85 241 549.
			Japan:	Protection granted.
			Norway:	Protection granted.
			Russia:	Protection granted.
			Switzerland:	Protected (refusal period has expired).
			Turkey:	Protection granted.
U.K.:	Protected as U.K. TM #M1074021.			
30	FLAVORSTONE	1074551	Australia:	Protected as Australia TM 1424418.
			China:	Protection granted.
			EU:	Protection granted.
			Germany:	Protected as DE 85 287 138.
			Japan:	Protection granted.
			Norway:	<i>Pending.</i>
			Russia:	Protection granted.
			Switzerland:	Protected (refusal period has expired).
			Turkey:	Protection granted.
U.K.:	Protected as U.K. TM #M1074551.			
31	ROCKIN' ABS	1076848	Australia:	Protected as Australia TM 1429886.
			China:	Protection granted.
			EU:	Protected (opposition by 3rd party withdrawn)
			Germany:	Protected (opposition by 3rd party withdrawn).
			Japan:	Protection granted following initial refusal.
			Norway:	Protection granted.
			Russia:	Protected.
			Switzerland:	Protected (refusal period has expired).
			Turkey:	Protection granted.
U.K.:	Protected as U.K. TM #M1076848.			

Trademark Registrations and Applications
Held by Thane International, Inc., Thane Direct Company and/or
Thane Direct Canada Inc.
As of October 12, 2015

	Mark	IR	Designated Countries & Status of Grant of Protection ("GOP" under IR)
32	TOTAL FLEX (figurative)	1082663	Australia: Protected as Australia TM 1437922.
			EU: Protection granted.
			Germany: Protected as DE 85 343 404.
			Japan: Protection granted.
			Norway: Protection granted.
			Russia: Protection granted.
			Switzerland: Protected (refusal period has expired).
			Turkey: Protection granted.
			U.K.: Protected as U.K. TM #M1082663.
Vietnam: Protected (refusal period has expired).			

	Mark	IR	Designated Countries & Status of Grant of Protection ("GOP" under IR)
33	H2O X5	1096604	Australia: Protected as Australia TM 1461026.
			China: Protection granted.
			EU: Protected granted.
			Germany: Protected (refusal period has expired).
			Japan: Protection granted.
			Mexico: Protection granted.
			Norway: Protection granted.
			Switzerland: Protected (refusal period has expired).
			Turkey: Protection granted.
			U.K.: Protected as UK TM #M1096604.
Vietnam: <i>Refused; response filed.</i>			

34	STEAM LAZER	1120928	Australia: Protected as Australia TM 1503177.
			EU: Protection granted.
			Switzerland: Protected (refusal period has expired).

35	RED FUSION	1126000	Australia: Protected as Australia TM 1512707.
			China: Protection granted.
			EU: Protection granted.
			Germany: Protected (refusal period has expired).
			Japan: Protection granted.
			Norway: Protection granted.
			Russia: Protection granted.
			Switzerland: Protection granted.
			Turkey: Protection granted.
			U.K.: Protected as U.K. TM #M1126000.
Vietnam: Protection granted.			

Trademark Registrations and Applications
Held by Thane International, Inc., Thane Direct Company and/or
Thane Direct Canada Inc.
As of October 12, 2015

	Mark	IR	Designated Countries & Status of Grant of Protection ("GOP" under IR)	
36	SLIM 'N LIFT AIRE	1147337	EU:	Protection granted.
			Mexico:	Protection granted.
			Norway:	Protection granted.
			Russia:	Protection granted.
			Switzerland:	Protected (refusal period has expired).
			U.K.:	Protected as WO0000001147337.
37	FLAVORCHEF	1149798	Australia:	Protected as Australia TM 1544828.
			China:	Protection granted.
			EU:	Protection granted.
			Germany:	Protected (refusal period has expired).
			Japan:	Protection granted.
			Norway:	Protection granted.
			Russia:	Protection granted.
			Switzerland:	Protected (refusal period has expired).
			Turkey:	Protection granted.
			U.K.:	Protection granted.
Vietnam:	Protected (refusal period has expired).			
38	SLIM 'N LIFT CARESSE	1150921	Australia:	Protected as Australia TM 1150921.
			EU:	Protection granted.
			Japan:	Protection granted.
			Russia:	Protection granted.
			Switzerland:	Protected (refusal period has expired).
			Turkey:	Protection granted.
			U.K.:	Protected as WO0000001150921.
			Vietnam:	<i>Refused; response filed.</i>
39	SLIM 'N LIFT SHEER SECRET	1152347	Australia:	Protected as Australia TM 1548673.
			China:	Protection granted.
			EU:	Protection granted.
			Japan:	Protection granted.
			Norway:	Protected.
			Switzerland:	Protected (refusal period has expired).
			Turkey:	Protection granted.
			U.K.:	Protected as WO0000001152347.

Trademark Registrations and Applications
Held by Thane International, Inc., Thane Direct Company and/or
Thane Direct Canada Inc.
As of October 12, 2015

	Mark	IR	Designated Countries & Status of Grant of Protection ("GOP" under IR)	
40	H2O SteamFX	1159899	Australia:	Protected as Australia TM 1559980.
			EU:	Protection granted.
			Germany:	Protected (refusal period has expired).
			Japan:	Protection granted.
			Mexico:	Protection granted.
			Switzerland:	Protected (refusal period has expired).
			Turkey:	Protection granted.
U.K.:	Protected as WO0000001159899.			
41	H2O	1162687	Australia:	Protected as Australia TM 1563820
			Switzerland:	Protection granted in 2 of 3 applied classes.
			U.K.:	Protection granted.
42	VAC ATTACK	1170645*	Australia:	Protected as Australia TM 1574666.
			China:	Protection granted.
			EU:	Protection granted.
			Germany:	Protected (refusal period has expired).
			Japan:	Cancelled for non-payment of registration fee; to be abandoned.
			Mexico:	Protection granted.
			Norway:	Protection granted.
			Russia:	Protection granted.
			Switzerland:	Protected (refusal period has expired).
			Turkey:	Protection granted.
U.K.:	Protection granted.			
Vietnam:	Protection granted.			
*This IR will eventually be cancelled due the abandonment of the base U.S. application.				
43	SLIM 'N LIFT INFUSED	1172091	Australia:	Protected as Australia TM 1576074.
			EU:	Protection granted.
			Germany:	Protected (refusal period has expired).
			Japan:	Protection granted.
			Mexico:	Protection granted.
			Norway:	Protection granted.
			Russia:	Protection granted.
			Switzerland:	Protected (refusal period has expired).
			Turkey:	Protection granted.
U.K.:	Protection granted.			

Trademark Registrations and Applications
Held by Thane International, Inc., Thane Direct Company and/or
Thane Direct Canada Inc.
As of October 12, 2015

	Mark	IR	Designated Countries & Status of Grant of Protection ("GOP" under IR)
44	FLAVORFULL	1183383*	Australia: Protected as Australia TM 1594084.
			China: Protection granted.
			EU: Protection granted.
			Germany: Protected (refusal period has expired).
			Japan: Protection granted.
			Mexico: Protection granted.
			Norway: Protection granted.
			Russia: Pending.
			Switzerland: Protected (refusal period has expired).
			Turkey: Pending.
			U.K.: Protection granted.
			Vietnam: Protected (refusal period has expired).
45	THANE (rebrand logo)	1202757	Australia: Protected as Australia TM 1622976.
			China: Pending.
			EU: Protection granted.
			Germany: Protection granted.
			Japan: Pending.
			Mexico: Pending.
			New Zealand: Protection granted.
			Norway: Protection granted.
			Russia: Protection granted.
			Turkey: Protection granted.
			U.K.: Protection granted.
			Vietnam: Protected (refusal period has expired).
46	AB COMMAND	IR 1226346	Australia: Pending.
			China: Pending.
			EU: Pending.
			Germany: Protected (refusal period has expired).
			Japan: Protection granted.
			Mexico: Pending.
			Russia: Pending.
			Switzerland: Pending.
			Turkey: Pending.
			U.K.: Protection granted.
			Vietnam: Pending.

Trademark Registrations and Applications
Held by Thane International, Inc., Thane Direct Company and/or
Thane Direct Canada Inc.
As of October 12, 2015

	Mark	IR	Designated Countries & Status of Grant of Protection ("GOP" under IR)
47	IX2	1244811*	Australia: Protected as Australia TM 1690636.
			China: Pending.
			EU: Pending.
			Germany: Protected (refusal period has expired).
			Japan: Pending.
			Mexico: Pending
			Norway: Pending.
			Russia: Pending.
			Switzerland: Pending.
			Turkey: Pending.
U.K. Protection granted			
Vietnam Pending.			

*Protection under this IR, as shown above, is provisional at this time, as it is dependent on the U.S. application proceeding to registration within the first five years of the life of the IR.

48	ROBOPAL	1252601*	Australia: Pending.
			China: Pending.
			EU: Pending.
			Germany: Pending.
			Japan: Pending.
			Mexico: Pending
			Norway: Pending.
			Russia: Pending.
			Switzerland: Pending.
			Turkey: Pending.
U.K.: Protection granted.			

*Protection under this IR, as shown above, is provisional at this time, as it is dependent on the U.S. application proceeding to registration within the first five years of the life of the IR.

49	POWERX	1252993*	Australia: Protected as Australia TM 1702740.
			China: Pending.
			EU: Pending.
			Germany: Pending.
			Japan: Pending.
			Mexico: Pending
			Norway: Pending.
			Russia: Pending.
			Switzerland: Pending.
			Turkey: Pending.
U.K.: Protection granted.			

*Protection under this IR, as shown above, is provisional at this time, as it is dependent on the U.S. application proceeding to registration within the first five years of the life of the IR.

Trademark Registrations and Applications
Held by Thane International, Inc., Thane Direct Company and/or
Thane Direct Canada Inc.
As of October 12, 2015

	Mark	IR	Designated Countries & Status of Grant of Protection ("GOP" under IR)
50	H2O HD	A0052834	<i>Australia: Pending.</i>
			<i>China: Pending.</i>
			<i>EU: Pending.</i>
			<i>Germany: Pending.</i>
			<i>Japan: Pending.</i>
			<i>Mexico: Pending.</i>
			<i>Norway: Pending.</i>
			<i>Russia: Pending.</i>
			<i>Switzerland: Pending.</i>
			<i>Turkey: Pending.</i>
			<i>U.K.: Pending.</i>

DOMAIN NAME REGISTRATIONS HELD BY THANE INTERNATIONAL, INC. AS OF OCTOBER 9, 2015

DomainName	ExpirationDate
3MINLEGS.CA	9/1/2016
3MINLEGS.COM	12/25/2015
3MINUTELEGS.CA	10/28/2015
3MINUTELEGS.COM	10/28/2015
3MINUTES.CA	9/1/2016
3MINUTESLEG.CA	5/7/2016
3MINUTESLEG.COM	5/7/2016
3MINUTESLEGS.CA	5/7/2016
3MINUTESLEGS.COM	5/7/2016
3MLTOTALTRANSFORMATIONS.COM	05/19/2016
9MINUTEMARINATOR.COM	2/8/2016
ABDOER.ASIA	05/29/2016
ABDOER.CA	9/1/2016
ABDOER.COM	12/2/2016
ABDOER01.COM	11/11/2015
ABDOER02.COM	11/11/2015
ABDOER03.COM	11/11/2015
ABDOER04.COM	11/11/2015
ABDOER05.COM	11/11/2015
ABDOER06.COM	11/11/2015
ABDOER07.COM	11/11/2015
ABDOER08.COM	11/11/2015
ABDOER09.COM	11/11/2015
ABDOER10.COM	11/11/2015
ABDOER11.COM	11/11/2015
ABDOER12.COM	11/11/2015
ABDOER13.COM	11/11/2015
ABDOER14.COM	11/11/2015
ABDOER15.COM	11/11/2015
ABDOER16.COM	11/11/2015
ABDOERPRODUCTS.COM	07/26/2016
ABDOERTWIST.CA	9/1/2016
ABDOERTWIST.COM	12/25/2015
ABLIGHTNING.COM	9/5/2016
ABSHARK.COM	12/17/2015
ABTRONIC2.CA	9/1/2016
ABTRONIC2.COM	12/25/2015
ABTRONICX2.CA	9/1/2016
ABTRONICX2.COM	12/25/2015
BOBDELMONTIQUE.COM	01/16/2016
BODYBLASTCARDIO.CA	6/3/2016
BODYBLASTCARDIO.COM	6/3/2016
BODYVIBESONLINE.COM	01/30/2016
BUYABTRONIC.COM	3/7/2016
BUYBODYVIBES.COM	01/30/2016

BUYH20MOP.CA	08/25/2016
BUYH20MOP.COM	08/25/2016
BUYH20MOPULTRA.COM	3/7/2016
BUYH20MOP.CA	08/25/2016
BUYH20MOP.COM	08/25/2016
BUYH2OVAC.COM	2/9/2016
BUYSLIMANDLIFT.CA	07/24/2016
BUYSLIMANDLIFT.COM	07/24/2016
BUYSLIMNLIFT.CA	07/24/2016
BUYSLIMNLIFT.COM	3/7/2016
BUYSONICPEELER.COM	3/7/2016
CALIFORNIABEAUTY.COM	03/22/2016
CARDIOBODYBLAST.CA	6/3/2016
CARDIOBODYBLAST.COM	6/3/2016
CLEVERFABRICS.COM	6/10/2016
CONTACTBODYBLAST.CA	2/3/2016
CONTACTBODYBLAST.COM	2/3/2016
FLAVORWAVE.CA	06/27/2016
FLAVORWAVETURBO.CA	04/22/2016
FLAVORWAVETURBO.COM	04/22/2016
FLAVORWAVETURBOOVEN.COM	05/30/2016
FOREVERBOND.CA	12/8/2016
FOREVERBOND.COM	12/8/2016
GUITAROVERNIGHT.COM	03/22/2016
H20MOP.CA	07/23/2016
H20MOPSERVICE.CA	07/31/2016
H20MOPULTRA.COM	3/7/2016
H20TURBO.COM	10/22/2015
H20TURBOVAC.COM	2/1/2016
H20ULTRA.CA	07/23/2016
H20ULTRA.COM	07/23/2016
H20VAC.CA	07/23/2016
H20VACTURBO.CA	07/23/2016
H20VACTURBO.COM	10/22/2015
H20MOP.CA	10/18/2015
H20MOPSERVICE.CA	05/14/2016
H20MOPSERVICE.COM	05/14/2016
H20MOPULTRA.CA	07/23/2016
H20MOPULTRA.COM	07/23/2016
H20TURBO.COM	2/1/2016
H20TURBOVAC.CA	10/21/2015
H20ULTRA.CA	07/23/2016
H20VAC.CA	05/31/2016
H20VAC.COM	05/31/2016
H20VACTURBO.CA	07/23/2016
H20VACTURBO.COM	3/1/2016
HANGWELLS.CA	07/14/2016

HANGWELLS.COM	07/14/2016
HAPPYCHOP.CA	07/22/2016
HAPPYCHOP.COM	04/15/2016
JUMPSNAP.CA	6/10/2016
KLEARACTION.COM	4/9/2016
KLEARACTIV.CA	2/4/2016
KLEARACTIV.COM	2/4/2016
LEGSXPRESS.CA	10/28/2015
LEGSXPRESS.COM	10/28/2015
LIGHTNINGABS.COM	9/5/2016
MEDIALATINOSOURCE.COM	05/30/2016
MICROGYM.CA	7/6/2016
MICROGYM.COM	09/26/2016
MINUTELEGS.CA	9/1/2016
MINUTELEGS.COM	12/25/2015
MINUTEMARINATOR.CA	05/20/2016
MRTOVEN.CA	07/30/2016
NEWBODYVIBES.COM	01/30/2016
ORBITREK.CA	01/14/2016
ORBITREK.COM	6/3/2016
ORBITREKELITE.CA	3/8/2016
ORBITREKELITE.COM	2/8/2016
ORBITREKTESTIMONIALS.COM	04/22/2016
PANLATINO.COM	4/3/2016
PERFECTDOG.CA	1/4/2016
QGRILL.COM	03/14/2016
ROLLERGLIDE.CA	12/27/2015
ROLLERGLIDER.CA	12/14/2015
RUSHITNOW.COM	02/14/2016
SLIMANDLIFT.CA	07/23/2016
SLIMANDLIFTSUPREME.CA	07/23/2016
SLIMNLIFT.CA	07/23/2016
SONICPEELER.CA	12/19/2015
SSG2.CA	10/16/2015
STEAMSTYLER.CA	06/13/2016
STEAMSTYLER.COM	06/13/2016
SUDDEN-GLOW.COM	03/31/2016
SUDDENGLOW.CA	03/31/2016
SUDDENLIFT.COM	9/7/2016
SUPREMESHAPER.CA	12/10/2015
TEVEBESTSELLERS.COM	2/1/2016
THANE-SHOPPING.COM	10/11/2015
THANE.CA	3/12/2015
THANE.COM	8/1/2016
THANE1.COM	03/30/2016
THANE10.COM	03/30/2016
THANE11.COM	03/30/2016

THANE12.COM	03/30/2016
THANE13.COM	03/30/2016
THANE14.COM	03/30/2016
THANE15.COM	03/30/2016
THANE16.COM	03/30/2016
THANE17.COM	07/30/2016
THANE18.COM	07/30/2016
THANE19.COM	07/30/2016
THANE2.COM	03/30/2016
THANE20.COM	07/30/2016
THANE21.COM	07/30/2016
THANE22.COM	07/30/2016
THANE23.COM	07/30/2016
THANE24.COM	07/30/2016
THANE25.COM	07/30/2016
THANE26.COM	07/30/2016
THANE27.COM	07/30/2016
THANE28.COM	07/30/2016
THANE29.COM	07/30/2016
THANE3.COM	03/30/2016
THANE30.COM	07/30/2016
THANE31.COM	07/30/2016
THANE32.COM	07/30/2016
THANE33.COM	07/30/2016
THANE34.COM	07/30/2016
THANE35.COM	07/30/2016
THANE36.COM	07/30/2016
THANE37.COM	07/30/2016
THANE38.COM	07/30/2016
THANE39.COM	07/30/2016
THANE4.COM	03/30/2016
THANE40.COM	07/30/2016
THANE41.COM	07/30/2016
THANE42.COM	07/30/2016
THANE43.COM	07/30/2016
THANE44.COM	07/30/2016
THANE45.COM	07/30/2016
THANE46.COM	07/30/2016
THANE47.COM	07/30/2016
THANE48.COM	07/30/2016
THANE49.COM	07/30/2016
THANE5.COM	03/30/2016
THANE50.COM	07/30/2016
THANE51.COM	07/30/2016
THANE52.COM	07/30/2016
THANE53.COM	07/30/2016
THANE54.COM	07/30/2016

THANE55.COM	07/30/2016
THANE56.COM	07/30/2016
THANE57.COM	07/30/2016
THANE58.COM	07/30/2016
THANE59.COM	07/30/2016
THANE6.COM	03/30/2016
THANE60.COM	07/30/2016
THANE61.COM	07/30/2016
THANE62.COM	07/30/2016
THANE63.COM	07/30/2016
THANE64.COM	07/30/2016
THANE65.COM	2/8/2016
THANE66.COM	1/8/2016
THANE67.COM	1/8/2016
THANE68.COM	1/8/2016
THANE69.COM	1/8/2016
THANE7.COM	03/30/2016
THANE70.COM	1/8/2016
THANE71.COM	8/1/2016
THANE72.COM	8/1/2016
THANE73.COM	8/1/2016
THANE74.COM	8/1/2016
THANE75.COM	8/1/2016
THANE76.COM	8/1/2016
THANE77.COM	8/1/2016
THANE78.COM	8/1/2016
THANE79.COM	8/1/2016
THANE8.COM	03/30/2016
THANE80.COM	8/1/2016
THANE81.COM	8/1/2016
THANE82.COM	8/1/2016
THANE83.COM	8/1/2016
THANE84.COM	8/1/2016
THANE85.COM	8/1/2016
THANE86.COM	8/1/2016
THANE87.COM	8/1/2016
THANE88.COM	8/1/2016
THANE89.COM	8/1/2016
THANE9.COM	03/30/2016
THANE90.COM	8/1/2016
THANE91.COM	8/1/2016
THANE92.COM	8/1/2016
THANE93.COM	8/1/2016
THANE94.COM	8/1/2016
THANE95.COM	8/1/2016
THANE96.COM	8/1/2016
THANE97.COM	8/1/2016

THANE98.COM	8/1/2016
THANE99.COM	8/1/2016
THANEDIRECT.BIZ	01/22/2016
THANEDIRECT.CA	5/12/2015
THANEDIRECT.COM	09/30/2016
THANEESPANOL.COM	7/5/2016
THANEHEALTH.COM	4/2/2016
THANEINTERNATIONAL.COM	03/22/2016
THANEWARRANTY.CA	7/4/2016
THEPERFECTDOG.CA	1/4/2016
TOTALVIBE.CA	07/23/2016
TOTALVIBES.CA	11/3/2016
TRUECOVER.CA	04/26/2016
TRUESLEEPER.CA	09/13/2016
TVINSWORKS.COM	10/5/2016
VACQUA.COM	03/17/2016
WHITENINGLIGHT.COM	08/20/2016
3MINUTELEGS.IT	09/13/2016
3MINUTELEGS.NL	10/6/2016
ABCURLDIRECT.COM	1/10/2016
ABDOERTWIST.IT	09/13/2016
ABDOERTWIST.NL	10/6/2016
ACHATDIRECT.TV	9/6/2016
AIRBRA.CA	11/7/2016
AIREBRA.CA	11/7/2016
AIREBRA.COM	6/7/2016
BUYABCURL.COM	1/10/2016
BUYABSNOW.CA	04/29/2016
BUYABSNOW.CO.UK	04/29/2018
BUYABSNOW.COM	04/29/2016
BUYAIRBRA.COM	6/7/2016
BUYAIREBRA.COM	6/7/2016
BUYBOUNCE.CA	9/2/2016
BUYFLAVORSTICK.COM	02/23/2016
BUYFLAVORWAVE.COM	7/10/2016
BUYGOGONAILS.CA	10/25/2015
BUYGOGONAILS.COM	10/15/2015
BUYLASHER.CA	03/21/2016
BUYROCKINABS.CA	11/22/2015
BUYROCKINABS.COM	11/22/2015
BUYROCKINGABS.CA	11/22/2015
BUYROCKINGABS.COM	11/22/2015
BUYSONA.COM	02/17/2016
BUYSONAPILLOW.CA	04/26/2016
BUYSONAPILLOW.CO.UK	04/26/2017
BUYSTEAMZONE.COM	11/10/2015
BUYSTEELABS.COM	04/29/2016

BUYSTICKTILES.COM	12/15/2015
BUYSTIKTILE.COM	12/15/2015
BUYSWIVELSWEEPER.CO.UK	5/5/2016
BUYTOTALFLEX.COM	02/17/2016
DERMASET.CA	12/2/2016
DERMASET.CO.UK	12/2/2017
DERMASET.COM	12/2/2016
DERMASETA.CA	10/2/2016
DERMASETA.CO.UK	10/2/2017
DERMASETA.COM	10/2/2016
DERMASETA.IT	09/13/2016
DERMASOFT.COM.BR	07/14/2016
DIRECTSHOPPING.TV	9/6/2016
FLAVORSTONE.COM	08/17/2016
FLAVORWAVECOOKING.COM	11/17/2015
FLAVORWAVEEXPRESS.CA	11/22/2015
FLAVORWAVEEXPRESS.COM	10/20/2015
FLAVOURSTICK.CA	1/12/2015
FLAVOURSTICK.CO.UK	1/12/2016
FLAVOURSTICK.COM	1/12/2015
FLAVOURWAVEEXPRESS.CA	10/20/2015
FLAVOURWAVEEXPRESS.CO.UK	10/20/2016
FOREVERBACK.CA	05/13/2016
GASLOOP.COM	6/6/2016
GETABCURL.COM	1/10/2016
GETBACK2LIFE.CO.UK	04/15/2017
GETFLAVORWAVE.COM	10/20/2015
GETROCKINABS.CA	11/22/2015
GETROCKINABS.COM	11/22/2015
GETROCKINGABS.CA	11/22/2015
GETROCKINGABS.COM	11/22/2015
GETSONAPILLOW.CA	04/26/2016
GETSONAPILLOW.CO.UK	04/26/2017
GETSONAPILLOW.COM	04/26/2016
GETSTEAMZONE.COM	11/10/2015
GETSTEELABSNOW.COM	03/20/2016
GETSWIVELSWEEPER.CO.UK	5/5/2016
GETTOBI.CA	07/14/2016
GETTOBI.COM	06/25/2016
GETTOTALFELX.COM	10/27/2015
GOGOSLIPPERS.CA	11/18/2015
GOGOSLIPPERS.COM	07/13/2016
H20MOP.IT	09/13/2016
H20X5.COM	6/10/2016
H20X5STEAM.COM	6/10/2016
H20MOPX5.CA	11/16/2015
H20MOPX5.COM	11/16/2015

H2OTURBOVAC.COM	10/21/2015
H2OX5STEAM.COM	6/10/2016
KLEAR-ACTION.COM	02/26/2016
KLEARACTIV.TV	2/4/2016
MARIWINDSOR.CA	03/17/2016
MARIWINSOR.CA	03/17/2016
MARYWINDSOR.CA	03/17/2016
MARYWINSOR.CA	03/17/2016
MEJORCOMPRA.TV	11/10/2015
MICROGYM.TV	7/6/2016
MIGHTYFLEX.CA	7/1/2016
MIGHTYFLEX.CO.UK	7/1/2016
MIGHTYFLEX.COM	7/1/2016
MINUTEMARINATOR.COM	05/20/2016
MOPX5.CA	11/16/2015
MOPX5.COM	11/16/2015
OFFICIALBODYVIBES.COM	01/30/2016
OVERNIGHTMUSIC.COM	8/1/2016
PANLATINO.TV	4/3/2016
ROCKINABSDIRECT.CA	11/22/2015
ROCKINABSDIRECT.COM	11/22/2015
ROCKINABSPARTS.CA	11/22/2015
ROCKINABSPARTS.COM	11/22/2015
ROCKINABSPRODUCT.CA	11/22/2015
ROCKINABSPRODUCT.COM	11/22/2015
ROCKINABSSERVICE.CA	11/22/2015
ROCKINABSSERVICE.COM	11/22/2015
ROCKINABSWORKOUT.CA	11/22/2015
ROCKINABSWORKOUT.COM	11/22/2015
ROCKINGABSDIRECT.CA	11/22/2015
ROCKINGABSDIRECT.COM	11/22/2015
ROLLERGLIDE.TV	12/27/2015
ROLLERGLIDER.TV	12/14/2015
SALADCHEF.CA	03/19/2016
SHOPPINGONTV.COM	12/8/2016
SLIMANDLIFTAIR.COM	07/27/2016
SLIMANDLIFTAIRE.COM	07/27/2016
SLIMNLIFTAIR.COM	07/27/2016
SLIMNLIFTAIRE.CA	07/29/2016
SLIMNLIFTAIRE.COM	07/27/2016
SLIMPILATES.CA	03/17/2016
SOLAMENTENTV.COM	05/30/2016
SOLEKEEPER.CA	8/1/2016
SOLEKEEPER.CO.UK	8/1/2016
SOLEKEEPERS.CA	8/1/2016
SOLEKEEPERS.CO.UK	8/1/2016
SOLEKEEPERS.COM	8/1/2016

SONAPILLOW.CA	9/5/2016
SONICPEELER.COM	12/19/2015
STEELABS.CA	04/28/2016
STEELABS.CO.UK	04/29/2018
STEELABSMACHINE.COM	03/20/2016
STEELABSREVIEWS.COM	10/3/2016
STEELABSWORKOUTS.COM	03/20/2016
STICKTILES.CA	12/15/2015
STICKTILES.CO.UK	12/15/2016
STIKTILE.CA	12/15/2015
STIKTILE.CO.UK	12/15/2016
STIKTILE.COM	12/15/2015
SUDDENGLOW.COM	03/31/2016
SUPREMESHAPER.COM	12/10/2015
SWIVELSWEEPERG2.IT	09/13/2016
TEVEGALLERY.COM	12/20/2015
THANE-AUSTRIA.AT	3/10/2016
THANE-BELGIQUE.COM	04/16/2016
THANE-DEUTSCHLAND.DE	08/17/2016
THANE-DIRECT.COM	05/13/2016
THANE-ESPANA.COM	04/14/2016
THANE-EUROPE.COM	04/14/2016
THANE-FITNESS.COM	10/11/2015
THANE-FRANCE.COM	04/14/2016
THANE-HOUSEWARES.COM	10/11/2015
THANE-INTERNATIONAL.COM	10/11/2015
THANE-ITALIA.COM	04/14/2016
THANE-OESTERREICH.AT	08/17/2016
THANE201.COM	11/12/2015
THANE202.COM	11/12/2015
THANE203.COM	11/12/2015
THANE204.COM	11/12/2015
THANE205.COM	11/12/2015
THANE206.COM	11/12/2015
THANE207.COM	11/12/2015
THANE208.COM	11/12/2015
THANE209.COM	11/12/2015
THANE210.COM	11/12/2015
THANE211.COM	11/12/2015
THANE212.COM	11/12/2015
THANE213.COM	11/12/2015
THANE214.COM	11/12/2015
THANE215.COM	11/12/2015
THANE216.COM	11/12/2015
THANE217.COM	11/12/2015
THANE218.COM	11/12/2015
THANE219.COM	11/12/2015

THANE220.COM	11/12/2015
THANE221.COM	11/12/2015
THANE222.COM	11/12/2015
THANE223.COM	11/12/2015
THANE224.COM	11/12/2015
THANE225.COM	11/12/2015
THANE226.COM	11/12/2015
THANE227.COM	11/12/2015
THANE228.COM	11/12/2015
THANE229.COM	11/12/2015
THANE230.COM	11/12/2015
THANEABTRONIC.COM	3/7/2016
THANECATALOG.COM	10/26/2015
THANECLUB.COM	08/20/2016
THANECYBERMALL.COM	03/22/2016
THANEDEV.COM	01/24/2016
THANEDEVELOPMENT.COM	07/17/2016
THANEDIRECT.NL	11/7/2016
THANEDIRECTMARKETING.COM	12/24/2015
THANEFITNESS.COM	03/22/2016
THANEINC.COM	4/1/2016
THANEMAIL.COM	08/20/2016
THANENEWSLETTER.COM	11/11/2015
THANEOVERSTOCK.COM	12/7/2016
THANEPRODUCTS.COM	1/4/2016
THANESLIMNLIFT.COM	3/7/2016
THANESONICPEELER.COM	3/7/2016
THANETV.COM	12/21/2015
THANEVISION.COM	12/16/2015
THANEWARRANTY.COM	09/29/2016
THEABDOER.COM	12/1/2016
THEABTRONIC.COM	3/7/2016
THEH20MOPULTRA.COM	3/7/2016
THEH20MOP.COM	12/21/2015
THEPERFECTDOG.COM	7/7/2016
THESLIMNLIFT.COM	3/7/2016
THESONICPEELER.COM	3/7/2016
THETOBIMAGIC.COM	6/1/2016
THETOTALFLEX.COM	7/1/2016
THEULTIMATECRUNCH.COM	04/14/2016
TIENDADIRECTATV.COM	9/12/2015
TIENDADIRECTATV.ES	9/12/2015
TOBIMAGIC.CA	6/1/2016
TOBIMAGIC.CO.UK	6/1/2016
TOBIMAGIC.COM	6/1/2016
TOBIQUICK.CA	5/1/2016
TOBIQUICK.CO.UK	5/1/2016

TOBISTEAMER.CA	11/27/2015
TOBIWAND.CA	08/20/2016
TOBIWAND.COM	07/30/2016
TOTALFLEX.CA	7/1/2016
TOTALFLEX.CO.UK	7/1/2016
TOTALFLEXDIRECT.COM	10/27/2015
TOTALFLEXGYM.COM	10/27/2015
TOTALFLEXHOMEGYM.COM	10/27/2015
TOTALVIBES.COM	11/3/2016
TREND-PRO.TV	1/11/2015
TRENDPRO.TV	1/11/2015
TRIMFLEXBODY.COM	6/10/2016
TRUE-COVER.COM	04/26/2016
TRUE-SLEEPER.COM	11/15/2015
TRUEBACK.CA	05/25/2016
TRUESLUMBER.COM	7/3/2016
TRYBOUNCE.CA	9/2/2016
TVAIRBRA.COM	6/7/2016
TVAIREBRA.COM	6/7/2016
TVINS.COM	11/21/2015
TVSHOPUSA.COM	11/22/2015
ULTIMATECRUNCH.CA	6/1/2016
VACQUA.TV	03/17/2016
VENTASPORTV.COM	05/18/2016
WINDSORSLIM.CA	03/17/2016
WINSORPILATES.CA	03/15/2016
WINSORSLIM.CA	03/16/2016
X5MOP.CA	11/16/2015
X5MOP.COM	11/16/2015
X5STEAM.COM	6/10/2016
X5STEAMER.COM	6/10/2016
YOUTHCOCKTAIL.COM	03/22/2016
ABCOMMAND.CA	9/1/2016
ABCOMMAND.COM	2/1/2016
ABCOMMAND.MX	01/29/2016
ABCOMMAND.TV	8/4/2016
ABCOMMANDIX2.CA	9/1/2016
ABCOMMANDIX2.COM	9/1/2016
ABDOER.TV	8/5/2016
ABTRONIC.CA	9/1/2016
AGELESSWONDER.CA	2/12/2015
BACKBUBBLE.CA	03/23/2016
BAMBOOPILLOW.TV	8/4/2016
BOUTIQUEDEALS.TV	06/19/2016
BULLWORKER.CA	8/10/2015
BUYABCOMMAND.MX	01/29/2016
BUYAGELESSWONDER.COM	2/12/2015

BUYBACKBUBBLE.CA	03/24/2016
BUYBAMBOOPILLOW.CA	12/15/2015
BUYCARESSE.COM	03/19/2016
BUYCOPERX.COM	9/3/2016
BUYCOPPERX.CA	12/8/2016
BUYCOPPERX.COM	9/3/2016
BUYCURLSECRET.CA	08/30/2016
BUYFLAVORCHEF.COM	11/28/2015
BUYFLAVORFRESH.COM	07/22/2016
BUYFLAVORFRESHEXPRESS.COM	03/19/2016
BUYFLAVORFUL.COM	5/3/2016
BUYFLAVORFULL.COM	6/12/2015
BUYFLAVORGOURMET.COM	04/30/2016
BUYFLAVORMASTER.COM	10/22/2015
BUYFLAVORSTONE.COM	10/26/2015
BUYFUSIONGRILL.COM	2/4/2016
BUYH2OX5.CA	10/13/2015
BUYH2OX5.COM	10/13/2015
BUYINFUSED.CA	8/10/2015
BUYINFUSED.COM	11/13/2015
BUYINFUSIONGRILL.COM	04/17/2016
BUYMAKEMEBEAUTIFUL.COM	10/1/2016
BUYMAXIMIZER.CA	4/3/2016
BUYMOPHD.CA	8/10/2015
BUYMOPHD.COM	10/22/2015
BUYNANOGYM.CA	11/9/2016
BUYNANOGYM.COM	05/24/2016
BUYORBITREKX2.COM	01/27/2016
BUYPERFECTDOG.COM	09/16/2016
BUYPOWERX.CA	8/10/2015
BUYREDFUSION.COM	03/13/2016
BUYSMOOTHIEMAKER.CA	12/3/2016
BUYSTEAMFX.CA	04/23/2016
BUYSTEAMFX.COM	04/15/2016
BUYSTEAMLASER.COM	10/24/2015
BUYSTEAMLAZER.COM	10/24/2015
BUYSTEELABS.CA	11/11/2015
BUYSTREETSTRIDER.CA	03/25/2016
BUYSVELTE.CA	11/11/2015
BUYTHUNDERSTICK.CA	10/27/2015
BUYTHUNDERSTICK.COM	10/11/2015
BUYTOBI.COM	01/16/2016
BUYTOUCHOFGLAM.COM	11/26/2015
BUYTRUECOVER.COM	09/19/2016
BUYURBANSECRET.COM	07/30/2016
BUYVACATTACK.COM	10/26/2015
BUYWONDERCORE.CA	04/14/2016

BUYX5MOP.COM	9/7/2016
BUYX5PLUS.COM	11/13/2015
BUYX5VAC.COM	03/17/2016
CARESSE-SHAPEWEAR.COM	11/29/2015
CARESSEJEANS.CA	3/7/2016
CARESSESHAPEWEAR.COM	11/29/2015
CAROLBURNETT.CA	10/19/2015
COPPERXCOMPRESSIONWEAR.COM	9/3/2016
COPPERXDIRECT.COM	08/18/2016
DAMPFMOP.TV	07/20/2016
DOGTRAININGPLEDGESPECIAL.COM	09/17/2016
ELITEMOP.TV	08/29/2016
EMBRACE-BRA.COM	11/29/2015
FLAVORCHEF.CA	11/2/2016
FLAVORCHEFCOOKING.COM	11/28/2015
FLAVORCHEFCOOKS.COM	11/28/2015
FLAVORCHEFRECIPIES.COM	11/28/2015
FLAVORFRESHEXPRESS.COM	03/19/2016
FLAVORFULL.CA	01/23/2016
FLAVORMASTER.CA	8/10/2015
FLAVORMASTER.TV	8/4/2016
FLAVORQUIK.CA	06/26/2016
FLAVORSTONE.CA	10/27/2015
FLAVORSTONERED.CA	8/10/2015
FLAVOURCHEF.CA	11/2/2016
FLAVOURMASTER.TV	8/4/2020
FREEPADSFORLIFE.COM	08/31/2016
GETABCOMMAND.COM	8/4/2016
GETAIRFLOW.CA	12/8/2016
GETBODYSHRED.CA	12/8/2016
GETCOPPERX.COM	9/3/2016
GETFLAVORCHEF.COM	11/28/2015
GETFLAVORFRESH.COM	07/22/2016
GETFLAVORFRESHEXPRESS.COM	03/19/2016
GETFLAVORGOURMET.COM	04/30/2016
GETFLAVORSTONE.COM	10/26/2015
GETFUSIONGRILL.COM	2/4/2016
GETH2OX5.CA	10/13/2015
GETH2OX5.COM	10/13/2015
GETINFUSIONGRILL.COM	04/17/2016
GETNANOGYM.COM	05/24/2016
GETORBITREKX2.COM	01/27/2016
GETPERFECTDOG.COM	09/16/2016
GETTEAMFX.COM	04/15/2016
GETTEAMLASER.COM	10/24/2015
GETTEAMLAZER.COM	10/24/2015
GETTHUNDERSTICK.CA	10/27/2015

GETTHUNDERSTICK.COM	10/11/2015
GETTRUECOVER.COM	09/19/2016
GETTVBRACE.COM	6/5/2016
GETURBANSECRET.COM	07/30/2016
GETVACATTACK.COM	10/26/2015
GETX5VAC.COM	03/17/2016
H20MOPX5.CA	5/9/2016
H20X5.CA	5/9/2016
H20MOPSPRINGCLEAN.COM	10/4/2016
H20MOPX5.CO.UK	04/17/2017
H2OX5.CA	10/13/2015
H2OX5MOP.COM	9/7/2016
HDMOP.TV	8/4/2016
HYDROMOUSSE.FR	09/24/2016
JILLIANBODYREVOLUTION.CA	2/5/2016
LIVEASUPERLIFE.COM	6/12/2015
MEJORCOMPRATV.COM	12/25/2017
minimaxcharger.ca	09/18/2016
minimaxchargers.ca	09/18/2016
MOPX5PLUS.COM	11/13/2015
MYABCOMMAND.COM	09/24/2016
MYSMARTDIFFERENCE.COM	1/10/2016
NICERDICER.CA	11/9/2016
ORBITREKX2.CA	01/31/2016
ORBITREKX2.COM	01/27/2016
PERFECTCOLAR.COM	10/1/2016
PERFECTDOGCOLAR.COM	10/1/2016
PERFECTDOGCOLLAR.COM	10/1/2016
PERFECTDOGDIRECT.COM	01/23/2016
POWERX.TV	8/4/2016
PRESSUREPRO.TV	8/4/2016
REDFUSION.CA	03/13/2016
ROCKINABS.CA	8/10/2015
SAVEX5MOP.COM	11/7/2016
SEASONAIRE.CA	11/14/2015
SHEER-SECRET.COM	11/29/2015
SHOPTHANE.CA	4/2/2016
SHOPTHANE.CO.UK	4/2/2016
SHOPTHANE.DE	4/2/2016
SHOPTHANE.TV	4/2/2016
SLIMANDLIFTCARESSE.COM	11/28/2015
SLIMANDLIFTEMBRACE.COM	11/28/2015
SLIMANDLIFTSHEERSECRET.COM	11/28/2015
SLIMMINGJEANS.CA	8/12/2015
SNLJEANS.COM	12/19/2015
STEAM-ZONE.COM	11/10/2015
STEAMINGZONE.COM	11/10/2015

STEAMLASER.CA	10/24/2015
STEAMLASER.COM	10/24/2015
STEAMLAZER.CA	10/24/2015
STEAMLAZER.COM	10/24/2015
STEINPFANNE.TV	03/26/2016
SWIVELSWEEPERMAX.CA	4/12/2015
TAPOUTXT.CA	09/18/2016
TAPOUTXT.CO.UK	09/18/2016
TAPOUTXT.DE	09/17/2016
TAPOUTXT.MX	09/18/2016
TBMSWS.COM	8/2/2016
TELESHOPPING-CLUB.TV	4/7/2016
THANE.FR	9/4/2016
THANEMEDIA.COM	10/20/2015
THANERETAIL.CA	11/20/2016
THANETVILIGHT.COM	2/12/2015
THEDIRTDRONE.COM	07/24/2016
THEFLAVORSTONE.COM	10/26/2015
THEH2OX5.CA	10/13/2015
THEH2OX5.COM	10/13/2015
THEPERFECTCOLAR.COM	10/1/2016
THEPERFECTDOGCOLLAR.COM	10/1/2016
THEROBOPAL.COM	12/8/2016
THESTEAMLASER.COM	10/24/2015
THESTEAMLAZER.COM	10/24/2015
THESTEAMZONE.COM	11/10/2015
THETHUNDERSTICK.COM	2/10/2016
THEULTIMATEJUICER.COM	10/6/2016
THEX5MOP.COM	09/24/2016
THUNDERSTICKNOW.COM	10/11/2015
TOTALFLEX.TV	5/10/2016
TOUCHOFGLAM.CA	12/15/2015
TOUCHOFGLAM.COM	11/12/2015
TRACYANDERSONMETHOD.CA	4/6/2016
TRAINYOURDOGPLEDGESPECIAL.COM	09/17/2016
TRAINYOURDOGSHOW.COM	09/17/2016
TRAINYOURDOGSPECIAL.COM	09/17/2016
TRENDPRO-OUTLET.TV	11/29/2015
TRYABCOMMAND.COM	8/4/2016
TRYAGELESSWONDER.COM	2/12/2015
TRYCARESSE.CA	4/12/2015
TRYCARESSE.COM	03/19/2016
TRYCOPPERX.COM	08/18/2016
TRYFLAVORCHEF.COM	01/31/2016
TRYFLAVORFULL.COM	6/12/2015
TRYFLAVORGOURMET.COM	04/30/2016
TRYMAKEMEBEAUTIFUL.COM	10/1/2016

TRYNANOGYM.COM	08/28/2016
TRYTEAMFX.COM	04/15/2016
TRYTRUECOVER.COM	09/19/2016
TVBACKBRACE.COM	6/5/2016
TVBRACE.COM	6/5/2016
TWISTHEADPHONES.COM	10/23/2015
TXBUDDY.COM	3/6/2016
TYDPLEDGESPECIAL.COM	09/17/2016
URBAN-SECRET.CA	07/30/2016
URBAN-SECRET.COM	07/30/2016
urbanrebounder.ca	8/7/2016
VACATTACKNOW.COM	10/26/2015
VERIPAINT.CA	3/9/2016
WASCHBRETT.TV	02/20/2016
WONDERCORE.TV	8/4/2016
X5MOP.CO.UK	04/17/2017
X5MOP.TV	04/17/2016
X5PLUS.CA	10/29/2015
X5VAC.CA	04/22/2016
X5VAC.COM	03/17/2016
YOURROBOPAL.COM	12/8/2016

Domain Name	Registered Date	Renewal Date
3minlegs.co.uk	25/12/2008	25/12/2016
3minutelegs.co.uk	28/10/2008	28/10/2016
3minutesleg.co.uk	05/07/2009	05/07/2017
3minuteslegs.co.uk	05/07/2009	05/07/2017
9minutemarinator.co.uk	03/08/2006	03/08/2016
abcommand.dk	30/01/2015	30/01/2016
abcommand.no	30/01/2015	30/01/2016
abcommand.se	29/01/2015	29/01/2016
abcommand.uk	29/01/2015	29/01/2016
abdoertwist.co.uk	25/12/2008	25/12/2016
abdoer-twist.co.uk	14/04/2011	14/04/2017
ablighning.co.uk	11/05/2007	11/05/2017
abtronic2.co.uk	25/12/2008	25/12/2016
abtronicx2.co.uk	25/12/2008	25/12/2016
flavorwaveturbo.co.uk	22/04/2008	22/04/2016
h2omop.co.uk	21/10/2007	21/10/2017
h2oturbovac.co.uk	22/10/2007	22/10/2017
h2ovac.co.uk	31/05/2005	31/05/2017
klearactiv.co.uk	03/04/2004	03/04/2016
legsexpress.co.uk	28/10/2008	28/10/2016
lightningabs.co.uk	11/05/2007	11/05/2017
minutelegs.co.uk	25/12/2008	25/12/2016
orbitrekelite.co.uk	03/08/2006	03/08/2016
qvcsweden.se	22/02/2013	22/02/2016
rollerglide.co.uk	28/12/2006	28/12/2016
rollerglider.co.uk	14/12/2006	14/12/2016
sonicpeeler.co.uk	20/12/2006	20/12/2016
steamstyler.co.uk	13/06/2006	13/06/2016
stiktiles.co.uk	19/09/2013	19/09/2017
suddenglow.co.uk	31/03/2006	31/03/2016
swivelsweeper.nl	08/06/2010	08/06/2016
tevegallery.be	20/12/2007	20/12/2015
tevegallery.eu	07/07/2011	07/07/2016
tevegallery.fr	31/12/2007	21/01/2016
thane.de	06/10/2010	06/10/2016
thanedirect.co.uk	06/12/2001	06/12/2015
thanedirect.eu	23/01/2013	23/01/2016
thanenewsletter.co.uk	22/09/2009	22/09/2017
thane-schweiz.ch	19/08/2011	19/08/2016
thepperfectdog.co.uk	01/04/2008	01/04/2016
totalvibes.co.uk	12/03/2008	12/03/2016
truecover.co.uk	26/04/2006	26/04/2016
truesleeper.co.uk	31/10/2002	31/10/2016

Domain Name

thane.tv

tvins.se

tvins.dk

abcommand.fi

danoz.com.au

danozdirect.com.au

danoz.co.nz

danozdirect.co.nz

abcommand.com.au

abcommand.co.nz

thanedirect.ie

EXHIBIT A
FORM OF BILL OF SALE AND ASSIGNMENT
[SECTION 1.1.13]

BILL OF SALE AND

ASSIGNMENT AND ASSUMPTION AGREEMENT

WHEREAS, Richter Advisory Group Inc., solely in its capacity as Court Appointed Receiver of [insert name of applicable Debtor], (the “**Seller**”), has entered into an Offer to Purchase, dated [●] with [insert name of applicable Buyer] (the “**Buyer**”) and affiliates of Buyer (the “**Offer to Purchase**”); and

WHEREAS, the Offer to Purchase contemplates that the Seller and Buyer will execute a bill of sale and assignment in the form of this Bill of Sale and Assignment and Assumption Agreement with respect to Assets listed on Exhibit A attached hereto;

WHEREAS, capitalized terms used herein and not otherwise defined herein shall have the meanings ascribed to such terms in the Offer to Purchase;

NOW, THEREFORE, in consideration of the sale of the Assets and in accordance with the terms of the Offer to Purchase and for good and valuable consideration, the receipt and sufficiency of which is hereby acknowledged, the parties hereby agree as follows:

1. Subject to the terms of the Offer to Purchase, the Seller does hereby sell, transfer, assign and deliver to Buyer, its successors and assigns, forever, all of the right, title and interest of Seller in, to and under the Assets, including without limitation the Assets listed on Schedule A.

2. Subject to the terms of the Offer to Purchase, the Buyer does hereby assume and agree to pay, perform and discharge promptly and fully when due all of the Assumed Liabilities that are liabilities and obligations of the Seller.

3. For certainty, the Assets sold, transferred, assigned and delivered under this Bill of Sale and Assignment and Assumption Agreement are so sold, transferred, assigned and delivered on an “as is, where is” basis. Neither party makes any representations, warranties, or conditions to the other party, whether express, implied, statutory or otherwise, regarding any matter, including without limitation any implied warranties or

conditions of merchantable quality and fitness for a particular purpose and the provisions of Section 2.4 of the Offer to Purchase shall apply *mutatis mutandis*.

4. This Bill of Sale and Assignment and Assumption Agreement is governed by, and is to be construed and interpreted in accordance with, the laws of the Province of Ontario and the laws of Canada applicable in that Province.

5. The Buyer acknowledges that the persons signing this Bill of Sale and Assignment and Assumption Agreement on behalf of the Seller is acting solely in his/her capacity as an authorized signatory of the Seller, and the Seller is acting solely in its capacity as court appointed Receiver of the Debtor, and such persons and the Seller shall have no personal or corporate liability of any kind, whether in contract, in tort or otherwise.

6. This Bill of Sale and Assignment and Assumption Agreement may be executed and delivered by the parties in one or more counterparts, each of which when so executed and delivered will be an original and such counterparts will together constitute one and the same instrument. To evidence the fact that a party has executed this Agreement, such party may send a copy of its executed counterpart to the other party by Electronic Transmission and, if sent by email, in Portable Document File (PDF) format. That Party will be deemed to have executed this Agreement on the date it sent such Electronic Transmission.

IN WITNESS WHEREOF, each of the parties has executed this Bill of Sale and Assignment and Assumption Agreement as of _____.

**RICHTER ADVISORY GROUP INC., solely in its capacity as COURT APPOINTED RECEIVER OF [INSERT NAME OF APPLICABLE DEBTOR], and not in its personal capacity
Seller**

By: _____

[insert name of Buyer]
Buyer

By: _____

EXHIBIT A

EXHIBIT B
FORM OF INTELLECTUAL PROPERTY ASSIGNMENT AGREEMENT
[SECTION 1.1.35]

INTELLECTUAL PROPERTY ASSIGNMENT

WHEREAS, Richter Advisory Group Inc., solely in its capacity as Court Appointed Receiver of [insert name of applicable IP owner], (the “Assignor”), has entered into an Offer to Purchase, dated [●] with [UK Thane IP Co.] (the “Assignee”) and affiliates of Assignee (the “Offer to Purchase”); and

WHEREAS, the Offer to Purchase contemplates that the Assignor and Assignee will execute an assignment of intellectual property in the form of this Intellectual Property Assignment with respect to all Intellectual Property of the Assignor listed on Exhibit A attached hereto (“IP”);

WHEREAS, capitalized terms used herein and not otherwise defined herein shall have the meanings ascribed to such terms in the Offer to Purchase;

NOW, THEREFORE, for good and valuable consideration, the receipt and sufficiency of which is hereby acknowledged, the parties hereby agree as follows:

1. Subject to the terms of the Offer to Purchase, the Assignor hereby irrevocably assigns and transfers to Assignee, its successors and assigns, absolutely and forever, all of its right, title and interest, whether statutory or at common law, in and to the IP, including, without limitation, any registration therefor as set forth on Exhibit A; all of Assignor’s goodwill, if any, associated with the IP; and all of Assignor’s rights, if any, to sue for or make claims with respect to any past, present or future infringement or misappropriation of the IP.

2. For certainty, the IP is assigned on an “as is, where is” basis. Neither party makes any representations, warranties, or conditions to the other party, whether express, implied, statutory or otherwise, regarding any matter, including without limitation any implied warranties or conditions of merchantable quality, non-infringement of third party rights and fitness for a

particular purpose and the provisions of Section 2.4 of the Offer to Purchase shall apply *mutatis mutandis*.

3. Subject to Section 3, Assignor covenants and agrees to execute and deliver, without further consideration, any instruments or other documents, and to cooperate with Assignee in any manner, as may reasonably be required by Assignee to effectuate the terms of this Intellectual Property Assignment, including, without limitation, delivering or providing to Assignee such other instruments or documents as may be necessary to effectuate the recordation of this Intellectual Property Assignment with the Canadian Intellectual Property Office, the United States Patent and Trademark Office or other applicable intellectual property registries worldwide as set forth on the annexed Exhibit A.

4. Assignor hereby constitutes and appoints Assignee, and its successors and assigns, the true and lawful attorney of Assignor with full power of substitution in the name and stead of Assignor, but on behalf and for the benefit of Assignee, its successors and assigns, solely to give effect to the foregoing Section 3, and for no other purpose.

IN WITNESS WHEREOF, each of the parties has executed this Intellectual Property Assignment as of _____.

**RICHTER ADVISORY GROUP INC., , solely
in its capacity as COURT APPOINTED
RECEIVER OF [INSERT NAME OF
APPLICABLE IP OWNER], and not in its
personal capacity
Assignor**

By: _____

**[UK THANE IP CO.]
Assignee**

By: _____

EXHIBIT A

Description of IP	Cou ntry	Reg . #	Reg. Date	App. #	App. Date	Statu s	Renewa l
--------------------------	---------------------	--------------------	----------------------	-------------------	----------------------	--------------------	---------------------

EXHIBIT C
FORM OF INTELLECTUAL PROPERTY LICENSE AGREEMENT
[SECTION 1.1.36]

LICENCE AGREEMENT

THIS AGREEMENT made as of the _____ day of _____, 2015, between:

<*>

<ADDRESS>

(hereinafter called the "Licensor")

- and -

<*>

<ADDRESS>

(hereinafter called the "Licensee")

WHEREAS the Licensor has rights to Canadian trademarks, patents and other intellectual property as set out on Schedule "A" hereto. (collectively, subject to s. 2, below, the "**Licensed Intellectual Property**");

AND WHEREAS the Licensor wishes to licence the Licensed Intellectual Property on the terms set forth herein in respect of the products associated with the Licensed Intellectual Property ("**Licensed Products**");

NOW THEREFORE THIS AGREEMENT WITNESSES that, in consideration of the mutual covenants and agreements herein contained and subject to the terms and conditions hereinafter set out, the parties hereto agree as follows:

1. The Licensor hereby grants to the Licensee an exclusive, sublicensable, transferable licence <*> to use the Licensed Intellectual Property in the territory of <*> in association with the Licensed Products or as may be agreed upon at any time and from time to time by the Licensor and the Licensee.
2. The Licensor shall be entitled to add or delete intellectual property to Schedule "A" from time to time and at any time upon notice to the Licensee.
3. The Licensee shall clearly identify its use of the Licensed Intellectual Property as licensed use and identify the Licensor as the owner of the Licensed Intellectual Property. Subject to and without limiting the generality of the foregoing, such identification in printed materials shall be sufficient if it is in a small size but reasonably legible font and appears on the same page as the Licensed Intellectual Property.
4. The Licensee agrees to abide by standards for all of the Licensed Products as communicated from Licensor to Licensee from time to time, acting reasonably, and further agrees that the Licensor shall be entitled to conduct the necessary inspections of inventory, customer lists, marketing and other sales support material upon reasonable notice, and take all other actions appropriate for the purpose of determining that the

quality standards set forth in this Agreement are being maintained, or as otherwise necessary.

5. Financial Terms:

Reporting: The Licensee shall provide to the Licensor within 30 days following the end of each calendar quarter, gross sales and Net Sales (as defined in Schedule "B" hereto) of Licensed Products on a customer by customer basis for the prior quarter.

Royalty: The Licensee shall pay to the Licensor with respect to each calendar year during which this Agreement is in effect, any royalties or payments as set out in Schedule "B" hereto. The relevant royalty payment for a calendar quarter shall be made by Licensee within 20 days of the end of such calendar quarter.

6. The Licensee shall be wholly responsible for complying with all local regulations and laws relating to the advertising and sales promotions and shall keep the Licensor indemnified in the event of any infringement of such local regulations and laws.
7. The Licensee acknowledges the Licensor's exclusive right, title and interest in and to the Licenced Intellectual Property and the validity of any future registrations thereof and agrees that the Licenced Intellectual Property are and shall remain the sole and exclusive property of the Licensor in Canada and that, except for the licensed rights to use as provided by this Agreement, the Licensee has and will hereby acquire no rights in any of the Licenced Intellectual Property.
8. It is hereby acknowledged by the Licensee that the Licensor does not represent or warrant to the Licensee, and there is no condition that, any of the Licenced Intellectual Property is valid or enforceable or that use thereof or the provision of any Licensed Products under any of the Licenced Intellectual Property will not infringe or otherwise violate any rights of any other person.
9. The Licensee agrees that it shall not at any time during or after the term of this Agreement contest or do or cause to be done any act or thing, directly or indirectly, which would in any way impair, ridicule or depreciate any of the Licensor's right, title or interest in, or the validity of, any of the Licenced Intellectual Property.

The Licensee agrees that it shall not at any time during or after the term of this Agreement, directly or indirectly, in any manner represent that it has any ownership, beneficial or proprietary interest in any of the Licenced Intellectual Property or registrations thereof, other than the licensed rights to use as provided by this Agreement.

10. The initial term of this Agreement shall begin as at . This Agreement shall terminate on . This Agreement shall automatically renew for unless either party provides at least 90 days notice prior to the date of termination of this Agreement or any prior renewal termination date thereof, as the case may be.
11. The Licensor shall be entitled to terminate this Agreement on the following terms:
 - (a) immediately upon notice to the Licensee if any of the following shall occur (each of which is separate and independent):

- (i) the Licensee is adjudged bankrupt, becomes insolvent or is unable or is deemed to be unable or admits its inability to pay its debts and stops or threatens to stop payments generally or ceases or threatens to cease to carry on its business or major part thereof;
 - (ii) any action is taken for, or with a view to, liquidation, dissolution, winding-up, official management, bankruptcy or insolvency of the Licensee;
 - (iii) the Licensee ceases use of the Licenced Intellectual Property for a period of three months or greater.
 - (b) Upon termination or expiry of this Agreement, the Licensee shall cease to use in any manner all of the Licenced Intellectual Property except as expressly permitted by the Licensor.
 - (c) Any fees or royalties due as at the date of Termination shall remain due and payable.
12. The Licensee shall keep and maintain records sufficient to permit the Licensor to determine the Licensee's compliance with the terms and conditions of this Agreement.
 13. The rights and privileges hereby conferred on the Licensee under this Agreement are strictly personal to the Licensee and the Licensee shall not be entitled to assign, sell, encumber, give, convey, lend or otherwise transfer or license any of the rights granted hereunder or grant any sub-license of, or any other rights to, any of the licences granted to the Licensee hereunder without the prior written consent of the Licensor, which consent may be withheld for any reason whatsoever. Notwithstanding the previous sentence, the Licensee may assign its rights and obligations under this Agreement to an affiliate of 9472541 Canada Inc., provided such affiliate agrees to be bound to the terms of this Agreement.
 14. If any provision of this Agreement for any reason shall be declared void, illegal, invalid or unenforceable in whole or in part, such provision shall be severable from all other provisions herein and shall not affect or impair the validity or enforceability of any other provision of this Agreement.
 15. The parties hereby agree to do all acts and things that at any time and from time to time as may be required for the better carrying out and performance of the intention and terms of this Agreement.
 16. This Agreement shall enure to the benefit of and be binding upon the successors and permitted assigns of the parties hereto.
 17. Any notice, designation, communication, demand or other document (in this section a "Notice") required or permitted to be given hereunder to any party hereto shall be in writing and shall be sufficiently given or sent if it is delivered personally to an officer or a director of the party receiving the Notice, or it is delivered by regular mail to such party at its usual business address, or to such other address as such party receiving such Notice shall have communicated to the other party hereto.

- 18. This Agreement shall be governed by and construed in accordance with the laws of the Province of Ontario and the laws of Canada applicable therein and the parties hereto hereby irrevocably attorn to the jurisdiction of the courts of the Province of Ontario.
- 19. The failure of a party hereto to exercise or enforce any right conferred upon it by this Agreement shall not be deemed to be a waiver of any such right or operate so as to bar the exercise or enforcement thereof at any time or time thereafter.
- 20. This Agreement supersedes any prior agreements, whether written or oral and all communications between the Parties and constitutes the entire agreement of the Parties with respect to the subject matter hereof. No modification or variation of this Agreement shall be valid unless made in writing, clearly expressed to be a modification or variation, and executed by the Parties in the same manner as this Agreement.
- 21. Time is of the essence herein.

IN WITNESS WHEREOF this Agreement has been executed by the parties hereto as of the date written above.

[LICENSOR]

[LICENSEE]

By: _____
 Name:
 Title:

By: _____
 Name:
 Title:

SCHEDULE "A" - LICENSED TRADEMARKS

Trademarks



Patents



Other Intellectual Property



SCHEDULE "B" – FINANCIAL TERMS

Licensee agrees to pay Licensor ~~5%~~ % of Net Sales as a royalty, once Net Sales have reached or exceeded \$~~100,000~~. For clarity, no royalty payment shall be due on such first \$~~100,000~~.

"Net Sales" means all gross revenues booked in respect of the Licensed Products in the relevant calendar quarter, minus all directly attributable costs, inclusive of industry standard rebates and discounts.

24039001.3

EXHIBIT E-1
FORM OF APPOINTMENT ORDER
[SECTION 4.3]

Court File No.: -

**ONTARIO
SUPERIOR COURT OF JUSTICE
(COMMERCIAL LIST)**

THE HONOURABLE)	FRIDAY, THE 23rd DAY
)	
JUSTICE)	OF OCTOBER , 2015

BETWEEN:

BANK OF MONTREAL

Applicant

- and -

**THANE INTERNATIONAL, INC., THANE DIRECT, INC., THANE DIRECT
COMPANY, THANE DIRECT MARKETING INC., WEST COAST DIRECT
MARKETING, INC., THANE DIRECT CANADA INC. AND TDG, INC.**

Respondents

**APPLICATION UNDER section 243 of the *Bankruptcy and Insolvency Act*,
R.S.C. 1985, c. B-3, as amended, and under section 101 of the
Courts of Justice Act, R.S.O. 1990, c. C.43**

APPOINTMENT ORDER

THIS APPLICATION made by Bank of Montreal ("BMO" or the "Applicant") for an Order pursuant to section 243(1) of the *Bankruptcy and Insolvency Act*, R.S.C. 1985, c. B-3, as amended (the "BIA") and section 101 of the *Courts of Justice Act*, R.S.O. 1990, c. C.43, as amended (the "CJA") appointing Richter Advisory Group Inc. as receiver (the "Receiver"), without security, to exercise the powers and duties specifically set out in this Order with respect to the assets, undertakings and properties of the Respondents (collectively, the "Debtors") held

for, or used in relation to, a business carried on by the Debtors, was heard this day at 330 University Avenue, Toronto, Ontario.

ON READING the Affidavit of Paul Findlay sworn October 16, 2015, and the Exhibits thereto, and the Report of Richter Advisory Group Inc. (“Richter”) dated October ●, 2015 in its capacity as proposed Receiver (the “Pre-Appointment Report”) and on hearing the submissions of counsel for the Applicant, counsel for the Receiver and counsel for New Thane Holdco, no one appearing for any other party although duly served as appears from the Affidavits of Service of Alma Cano and on reading the Consent of Richter Advisory Group Inc. to act as the Receiver,

SERVICE

1. **THIS COURT ORDERS** that the time for service of the Notice of Application, the Application Record herein and the Pre-Appointment Report is hereby abridged, if necessary, and that this application is properly returnable today and that service, including the form, manner and time that such service was actually effected on all parties, is hereby validated, and where such service was not effected such service is hereby dispensed with.

APPOINTMENT

2. **THIS COURT ORDERS** that pursuant to section 243(1) of the BIA and section 101 of the CJA Richter is hereby appointed Receiver, without security, to exercise the powers and duties specifically set out in this Order with respect to the assets, undertakings and properties of the Debtors held for, and used in relation to, a business carried on by the Debtors (the “Property”) and all proceeds thereof.

3. **THIS COURT ORDERS** that subject to further Order of this Court, the Debtors shall remain in possession and control of the Property and the Receiver shall not be or be deemed to be in possession and control of the Property.

4. **THIS COURT ORDERS** that subject to further Order of this Court, the Debtors shall carry on their business in the normal course and shall pay the expenses arising from their business as they fall due and except to the extent that the Receiver exercises the powers granted

pursuant to paragraph 5 hereof the Receiver shall not interfere with the carrying on of the business of the Debtors.

RECEIVER'S POWERS

5. **THIS COURT ORDERS** that the Receiver is hereby empowered and authorized, but not obligated to do any of the following where the Receiver considers it necessary or desirable:

- (a) to take possession of and exercise control over any and all proceeds or receipts arising out of or from the Property;
- (b) to engage consultants, appraisers, agents, experts, auditors, accountants, managers, counsel and such other persons from time to time and on whatever basis, including on a temporary basis, to assist with the exercise of the Receiver's powers and duties, including without limitation those conferred by this Order;
- (c) to execute, assign, issue and endorse documents of whatever nature in respect of any of the Property, whether in the Receiver's name or in the name and on behalf of the Debtors, for any purpose pursuant to this Order;
- (d) to sell, convey, transfer or assign the Property or any part or parts thereof out of the ordinary course of business with the approval of this Court and in such case notice under subsection 63(4) of the Ontario *Personal Property Security Act*, or section 31 of the Ontario *Mortgages Act*, as the case may be, shall not be required, and in each case the Ontario *Bulk Sales Act* shall not apply;
- (e) to apply for any vesting order or other orders necessary to convey the Property or any part or parts thereof to a purchaser or purchasers thereof, free and clear of any liens or encumbrances affecting such Property;
- (f) to report to, meet with and discuss with such affected Persons (as defined below) as the Receiver deems appropriate on all matters relating to the Property and the receivership, and to share information, subject to such terms as to confidentiality as the Receiver deems advisable;

- (g) to register a copy of this Order and any other Orders in respect of the Property against title to any of the Property;
- (h) to take any steps reasonably incidental to the exercise of these powers or the performance of any statutory obligations.

and in each case where the Receiver takes any such actions or steps, it shall be exclusively authorized and empowered to do so, to the exclusion of all other Persons (as defined below), including the Debtors, and without interference from any other Person.

NO PROCEEDINGS AGAINST THE RECEIVER

6. **THIS COURT ORDERS** that no proceeding or enforcement process in any court or tribunal (each, a "Proceeding"), shall be commenced or continued against the Receiver except with the written consent of the Receiver or with leave of this Court.

NO PROCEEDINGS AGAINST THE DEBTORS OR THE PROPERTY

7. **THIS COURT ORDERS** that no Proceeding against or in respect of the Debtors or any one of them or the Property shall be commenced or continued except with the written consent of the Receiver or with leave of this Court and any and all Proceedings currently under way against or in respect of the Debtors or any one of them or the Property are hereby stayed and suspended pending further Order of this Court.

NO EXERCISE OF RIGHTS OR REMEDIES

8. **THIS COURT ORDERS** that all rights and remedies against the Debtors, the Receiver, or affecting the Property, are hereby stayed and suspended except with the written consent of the Receiver or leave of this Court, provided, however, that this stay and suspension does not apply in respect of any "eligible financial contract" as defined in the BIA, and further provided that nothing in this paragraph shall (i) empower the Debtors to carry on any business which the Debtors are not lawfully entitled to carry on, (ii) exempt the Debtors from compliance with statutory or regulatory provisions relating to health, safety or the environment, (iii) prevent the filing of any registration to preserve or perfect a security interest, or (iv) prevent the registration of a claim for lien.

NO INTERFERENCE WITH CONTRACTS

9. **THIS COURT ORDERS** that no Person shall discontinue, fail to honour, alter, interfere with, repudiate, terminate or cease to perform any right, renewal right, contract, agreement, licence or permit in favour of or held by the Debtors or any one of them, without written consent of the Receiver or leave of this Court.

CONTINUATION OF SERVICES

10. **THIS COURT ORDERS** that all Persons having oral or written agreements with the Debtors or any one of them, or statutory or regulatory mandates for the supply of goods and/or services, including without limitation, all computer software, communication and other data services, centralized banking services, payroll services, insurance, transportation services, utility or other services to the Debtors or any one of them, are hereby restrained until further Order of this Court from discontinuing, altering, interfering with or terminating the supply of such goods or services as may be required by the Debtors or any one of them, and that the Debtors shall be entitled to the continued use of their current telephone numbers, facsimile numbers, internet addresses and domain names, provided in each case that the normal prices or charges for all such goods or services received after the date of this Order are paid by the Debtors in accordance with normal payment practices of the Debtors or such other practices as may be agreed upon by the supplier or service provider and the Debtors, or as may be ordered by this Court.

EMPLOYEES

11. **THIS COURT ORDERS** that all employees of the Debtors shall remain the employees of the Debtors until such time as the Debtors may terminate the employment of such employees. The Receiver shall not be liable for any employee-related liabilities, including any successor employer liabilities as provided for in section 14.06(1.2) of the BIA.

LIMITATION ON ENVIRONMENTAL LIABILITIES

12. **THIS COURT ORDERS** that nothing herein contained shall require the Receiver to occupy or to take control, care, charge, possession or management (separately and/or collectively, "Possession") of any of the Property that might be environmentally contaminated, might be a pollutant or a contaminant, or might cause or contribute to a spill, discharge, release

or deposit of a substance contrary to any federal, provincial or other law respecting the protection, conservation, enhancement, remediation or rehabilitation of the environment or relating to the disposal of waste or other contamination including, without limitation, the *Canadian Environmental Protection Act*, the *Ontario Environmental Protection Act*, the *Ontario Water Resources Act*, or the *Ontario Occupational Health and Safety Act* and regulations thereunder (the “Environmental Legislation”), provided however that nothing herein shall exempt the Receiver from any duty to report or make disclosure imposed by applicable Environmental Legislation. The Receiver shall not, as a result of this Order or anything done in pursuance of the Receiver’s duties and powers under this Order, be deemed to be in Possession of any of the Property within the meaning of any Environmental Legislation, unless it is actually in possession.

LIMITATION ON THE RECEIVER’S LIABILITY

13. **THIS COURT ORDERS** that the Receiver shall incur no liability or obligation as a result of its appointment, the carrying out of the provisions of this Order, or arising from the business carried on by the Debtors, including liabilities or obligations in respect of taxes, withholdings, interest, penalties or other like claims, save and except for any gross negligence or wilful misconduct on its part. Nothing in this Order shall derogate from the protections afforded the Receiver by section 14.06 of the BIA or by any other applicable legislation.

RECEIVER’S ACCOUNTS

14. **THIS COURT ORDERS** that the Receiver and counsel to the Receiver shall be paid their reasonable fees and disbursements, in each case at their standard rates and charges unless otherwise ordered by the Court on the passing of accounts, and that the Receiver and counsel to the Receiver shall be entitled to and are hereby granted a charge (the “Receiver’s Charge”) on the Property, as security for such fees and disbursements, both before and after the making of this Order in respect of these proceedings, and that the Receiver’s Charge shall form a first charge on the Property in priority to all security interests, trusts, liens, charges and encumbrances, statutory or otherwise, in favour of any Person, but subject to sections 14.06(7), 81.4(4), and 81.6(2) of the BIA.

15. THIS COURT ORDERS that the Receiver and its legal counsel shall pass its accounts from time to time, and for this purpose the accounts of the Receiver and its legal counsel are hereby referred to a judge of the Commercial List of the Ontario Superior Court of Justice.

SERVICE AND NOTICE

16. THIS COURT ORDERS that the E-Service Protocol of the Commercial List (the "Protocol") is approved and adopted by reference herein and, in this proceeding, the service of documents made in accordance with the Protocol (which can be found on the Commercial List website at <http://www.ontariocourts.ca/scj/practice/practice-directions/toronto/e-service-protocol/>) shall be valid and effective service. Subject to Rule 17.05 this Order shall constitute an order for substituted service pursuant to Rule 16.04 of the Rules of Civil Procedure. Subject to Rule 3.01(d) of the Rules of Civil Procedure and paragraph 21 of the Protocol, service of documents in accordance with the Protocol will be effective on transmission. This Court further orders that a Case Website shall be established in accordance with the Protocol with the following URL <http://www.richter.ca/en/folder/insolvency-cases/t/thane-direct-company-et-al>.

17. THIS COURT ORDERS that if the service or distribution of documents in accordance with the Protocol is not practicable, the Receiver is at liberty to serve or distribute this Order, any other materials and orders in these proceedings, any notices or other correspondence, by forwarding true copies thereof by prepaid ordinary mail, courier, personal delivery or facsimile transmission to the Debtor's creditors or other interested parties at their respective addresses as last shown on the records of the Debtors and that any such service or distribution by courier, personal delivery or facsimile transmission shall be deemed to be received on the next business day following the date of forwarding thereof, or if sent by ordinary mail, on the third business day after mailing.

BANKRUPTCY OF THE DEBTORS

18. THIS COURT ORDERS that nothing in this Order shall prevent the Receiver from acting as a trustee in bankruptcy of the Debtors.

19. THIS COURT ORDERS that the Receiver is hereby authorized and empowered but not obligated to make assignments in bankruptcy and act as trustee in bankruptcy (in such capacity

the "Trustee") in respect of those Debtors that reside, carry on business or have property in Canada. In respect of any of the Debtors that do not reside, carry on business or have property in Canada, the Receiver is authorized and empowered but not obligated to take like steps under the laws of the United States, to the extent permitted by applicable law.

GENERAL

20. THIS COURT ORDERS that the Receiver may from time to time apply to this Court for advice and directions in the discharge of its powers and duties hereunder.

21. THIS COURT ORDERS that the Receiver is hereby appointed as the authorized foreign representative of the Debtors for the purposes of taking proceedings pursuant to Chapter 15 of the United States Bankruptcy Code in respect of the Debtors and is authorized to take such proceedings.

22. THIS COURT HEREBY REQUESTS the aid and recognition of any court, tribunal, regulatory or administrative body having jurisdiction in Canada or in the United States to give effect to this Order and to assist the Receiver and its agents in carrying out the terms of this Order. All courts, tribunals, regulatory and administrative bodies are hereby respectfully requested to make such orders and to provide such assistance to the Receiver, as an officer of this Court, as may be necessary or desirable to give effect to this Order or to assist the Receiver and its agents in carrying out the terms of this Order.

23. THIS COURT ORDERS that the Receiver be at liberty and is hereby authorized and empowered to apply to any court, tribunal, regulatory or administrative body, wherever located, for the recognition of this Order and for assistance in carrying out the terms of this Order, and that the Receiver is authorized and empowered to act as a representative in respect of the within proceedings for the purpose of having these proceedings recognized in a jurisdiction outside Canada.

24. THIS COURT ORDERS that any interested party may apply to this Court to vary or amend this Order on not less than seven (7) days' notice to the Receiver and to any other party likely to be affected by the order sought or upon such other notice, if any, as this Court may order.

<p>BANK OF MONTREAL - and - THANE INTERNATIONAL, INC., et. al.</p>		<p>Court File No.: ●</p>
<p>Applicant</p>	<p>Respondents</p>	
		<p>ONTARIO SUPERIOR COURT OF JUSTICE (COMMERCIAL LIST)</p> <p>(PROCEEDING COMMENCED AT TORONTO)</p>
		<p>APPOINTMENT ORDER</p>
		<p>Gowling Lafleur Henderson LLP Barristers and Solicitors 1 First Canadian Place 100 King Street West, Suite 1600 Toronto, Ontario M5X 1G5</p> <p>Clifton P. Prophet (LSUC No.: 34845K) Telephone: (416) 862-3509 Facsimile: (416) 862-7661</p> <p>Solicitors for Bank of Montreal</p>

EXHIBIT E-2
FORM OF CANADIAN APPROVAL AND VESTING ORDER
[SECTION 4.3]

Court File No.: CV-15- ●

**ONTARIO
SUPERIOR COURT OF JUSTICE
(COMMERCIAL LIST)**

THE HONOURABLE)	FRIDAY, THE 23rd DAY
)	
JUSTICE)	OF OCTOBER , 2015

BETWEEN:

BANK OF MONTREAL

Applicant

- and -

**THANE INTERNATIONAL, INC., THANE DIRECT, INC., THANE DIRECT
COMPANY, THANE DIRECT MARKETING INC., WEST COAST DIRECT
MARKETING, INC., THANE DIRECT CANADA INC. AND TDG, INC.**

Respondents

**APPLICATION UNDER section 243 of the *Bankruptcy and Insolvency Act*,
R.S.C. 1985, c. B-3, as amended, and under section 101 of the
Courts of Justice Act, R.S.O. 1990, c. C.43**

APPROVAL, VESTING AND DISTRIBUTION ORDER

THIS APPLICATION made by Bank of Montreal, in its capacity as agent (“**BMO**” or the “**Applicant**”) for certain lenders, including Bank of Montreal, forming a syndicate (the “**Lenders**”) pursuant to a Credit Agreement dated September 28, 2012 between BMO and the Lenders and the Respondents and certain other related entities, as amended from time to time (the “**Credit Agreement**”), for an Order:

- (a) approving the sale transaction (the "**Transaction**") contemplated by an offer to purchase (the "**Sale Agreement**") made to Richter Advisory Group Inc. in its capacity as receiver of the Respondents (the "**Receiver**" or the "**Seller**") by 9472541 Canada Inc., 9472550 Canada Inc., 635427, Inc. and 652134 Limited as purchasers. (together, the "**New Thane Purchasers**") dated October 16, 2015 and appended to the Affidavit of Paul Findlay sworn October 16, 2015 (the "**Findlay Affidavit**");
- (b) authorizing and directing the Receiver to enter into the Sale Agreement and vesting in the New Thane Purchasers the right, title and interest in and to the assets of the Debtors (defined below) to be sold pursuant to and as described in the Sale Agreement (the "**Assets**");
- (c) providing for distribution to the Lenders of the cash purchase price for the Assets; and,
- (d) for related relief,

was heard this day at 330 University Avenue, Toronto, Ontario.

ON READING the Findlay Affidavit and the Exhibits thereto, and the Report of Richter Advisory Group Inc. ("**Richter**") dated October ●, 2015 in its capacity as proposed Receiver (the "**Pre-Appointment Report**") and the Supplementary Report of Richter dated October ●, 2015 (the "**Supplementary Report**") and on hearing the submissions of counsel for BMO, counsel for the Receiver, counsel for the Respondents Thane International, Inc., Thane Direct, Inc., Thane Direct Company, Thane Direct Marketing Inc., West Coast Direct Marketing, Inc., Thane Direct Canada Inc. and TDG, Inc. (together, the "**Debtors**") and counsel for the New Thane Purchasers, no one appearing for any other party although duly served as appears from the Affidavits of Service of Alma Cano,

SERVICE

1. **THIS COURT ORDERS** that the time for service of the Notice of Application, the Application Record herein and the Pre-Appointment Report is hereby abridged, if necessary, and

that this application is properly returnable today and that service, including the form, manner and time that such service was actually effected on all parties, is hereby validated, and where such service was not effected such service is hereby dispensed with.

APPROVAL

2. **THIS COURT ORDERS AND DECLARES** that the Transaction and the Sale Agreement are hereby approved, and that the Sale Agreement is commercially reasonable and in the best interests of the Debtors and their stakeholders. The Receiver is hereby authorized and directed to execute the Sale Agreement, with such minor amendments as the Receiver may deem necessary. The Receiver is hereby further authorized and directed to take such additional steps and execute such additional documents as may be necessary or desirable for the completion of the Transaction and for the conveyance of the Assets to the New Thane Purchasers, including, without limitation, taking proceedings pursuant to Chapter 15 of the United States Bankruptcy Code in respect of the Transaction and the Sale Agreement.

3. **THIS COURT ORDERS** that the Pre-Appointment Report, the Supplementary Report and the activities and conduct of Richter described therein be and the same are hereby approved.

VESTING AND DISTRIBUTION

4. **THIS COURT ORDERS AND DECLARES** that upon the delivery of a Receiver's certificate to the New Thane Purchasers substantially in the form attached as **Schedule "A"** hereto (the "**Receiver's Certificate**"), all of the Debtors' right, title and interest in and to the Assets described in the Sale Agreement and described in summary form in **Schedule "B"** hereto shall vest absolutely in each of the New Thane Purchasers as set out in **Schedule "B"**, free and clear of and from any and all security interests (whether contractual, statutory, or otherwise), hypothecs, mortgages, trusts or deemed trusts (whether contractual, statutory, or otherwise), liens, executions, levies, charges, or other financial or monetary claims, whether or not they have attached or been perfected, registered or filed and whether secured, unsecured or otherwise (collectively, the "**Claims**") including, without limiting the generality of the foregoing: (i) any encumbrances or charges created by the Order of the Honourable Justice ● dated ●, 20●; (ii) all charges, security interests or claims evidenced by registrations pursuant to the *Personal*

Property Security Act (Ontario) or any other personal property registry system; and (iii) those Claims listed on **Schedule "C"** hereto (all of which are collectively referred to as the "**Encumbrances**" which term shall not include the permitted encumbrances listed on **Schedule "D"** hereto) and, for greater certainty, this Court orders that all of the Encumbrances affecting or relating to the Assets are hereby expunged and discharged as against the Assets.

5. **THIS COURT ORDERS AND DIRECTS** the Receiver to file with the Court a copy of the Receiver's Certificate, forthwith after delivery thereof.

6. **THIS COURT ORDERS** that all cash proceeds of sale of the Assets as provided for under the Sale Agreement shall, as part of the closing of the Transactions, be immediately paid or caused to be paid by the Receiver to the Agent for the benefit of the Lenders (the "**Distribution**") to be applied on account of and in partial payment of the obligations due and owing by the Debtors or any of them to the Lenders pursuant to the Credit Agreement and the Distribution may be effected by way of direction.

7. **THIS COURT ORDERS** that, pursuant to clause 7(3)(c) of the *Canada Personal Information Protection and Electronic Documents Act*, the Receiver and the Debtors are authorized and permitted to disclose and transfer to the New Thane Purchasers all human resources and payroll information in the Company's records pertaining to the Debtor's past and current employees, including personal information of those employees to be hired by the New Thane Purchasers pursuant to the Sale Agreement. The New Thane Purchasers shall maintain and protect the privacy of such information and shall be entitled to use the personal information provided to it in a manner which is in all material respects identical to the prior use of such information by the Debtor.

8. **THIS COURT ORDERS** that, notwithstanding:

- (a) the pendency of these proceedings;
- (b) any applications for a bankruptcy order now or hereafter issued pursuant to the *Bankruptcy and Insolvency Act* (Canada) in respect of the Debtors and any bankruptcy order issued pursuant to any such applications; and

- (c) any assignment in bankruptcy made in respect of the Debtors;

the vesting of the Assets in the New Thane Purchasers pursuant to this Order shall be binding on any trustee in bankruptcy that may be appointed in respect of the Debtors and shall not be void or voidable by creditors of the Debtors, nor shall it constitute nor be deemed to be a fraudulent preference, assignment, fraudulent conveyance, transfer at undervalue, or other reviewable transaction under the *Bankruptcy and Insolvency Act* (Canada) or any other applicable federal or provincial legislation, nor shall it constitute oppressive or unfairly prejudicial conduct pursuant to any applicable federal or provincial legislation.

9. **THIS COURT ORDERS AND DECLARES** that the Transaction is exempt from the application of the *Bulk Sales Act* (Ontario).

SEALING

10. **THIS COURT ORDERS AND DECLARES** that Appendix “●” to the ●, being the Report on Valuation of the Debtors dated October 16, 2015 prepared by Ernst & Young LLP (the “**Valuation Report**”), and paragraphs ● of the ● and paragraph ● of the Findlay Affidavit, being summaries of or references to the Valuation Report, shall be treated as confidential and shall be sealed and segregated from the public record, pending the closing of the Transaction contemplated by the Sale Agreement.

GENERAL

11. **THIS COURT ORDERS** that the Receiver may from time to time apply to this Court for advice and directions in the discharge of its powers and duties hereunder.

12. **THIS COURT HEREBY REQUESTS** the aid and recognition of any court, tribunal, regulatory or administrative body having jurisdiction in Canada or in the United States to give effect to this Order and to assist the Receiver and its agents in carrying out the terms of this Order. All courts, tribunals, regulatory and administrative bodies are hereby respectfully requested to make such orders and to provide such assistance to the Receiver, as an officer of this Court, as may be necessary or desirable to give effect to this Order or to assist the Receiver and its agents in carrying out the terms of this Order.

13. **THIS COURT ORDERS** that the Receiver be at liberty and is hereby authorized and empowered to apply to any court, tribunal, regulatory or administrative body, wherever located, for the recognition of this Order and for assistance in carrying out the terms of this Order, and that the Receiver is authorized and empowered to act as a representative in respect of the within proceedings for the purpose of having these proceedings recognized in a jurisdiction outside Canada.

SCHEDULE "A"**Form of Receiver's Certificate**

Court File No.: CV-15- ●

**ONTARIO
SUPERIOR COURT OF JUSTICE
(COMMERCIAL LIST)**

BETWEEN:

BANK OF MONTREAL

Applicant

- and -

**THANE INTERNATIONAL, INC., THANE DIRECT, INC., THANE DIRECT
COMPANY, THANE DIRECT MARKETING INC., WEST COAST DIRECT
MARKETING, INC., THANE DIRECT CANADA INC. AND TDG, INC.**

Respondents

**APPLICATION UNDER section 243 of the *Bankruptcy and Insolvency Act*,
R.S.C. 1985, c. B-3, as amended, and under section 101 of the
Courts of Justice Act, R.S.O. 1990, c. C.43****RECEIVER'S CERTIFICATE****RECITALS**

A. Pursuant to an Order of the Honourable ● of the Ontario Superior Court of Justice (the "Court") dated ●, Richter Advisory Group Inc. was appointed as the receiver (the "Receiver") of the assets, undertakings and properties of the Respondents (the "Debtors").

B. Pursuant to an Order of the Court dated ●, the Court approved the sale transaction (the “**Transaction**”) contemplated by an offer to purchase made to the Receiver by 9472541 Canada Inc., 9472550 Canada Inc., 635427, Inc. and 652134 Limited (together, the “**New Thane Purchasers**”) made as of October 16, 2015 (the “**Sale Agreement**”) and provided for the vesting in the New Thane Purchasers of the Debtors’ right, title and interest in and to the assets of the Debtors to be sold pursuant to and as described in the Sale Agreement, (the “**Assets**”), which vesting is to be effective with respect to the Assets upon the delivery by the Receiver to the New Thane Purchasers of a certificate confirming (i) the payment by the New Thane Purchasers of the Purchase Price (as defined in the Sale Agreement) for the Assets; (ii) that the conditions to Closing as set out in Article 4 of the Sale Agreement have been satisfied or waived by the Receiver and the New Thane Purchasers; and (iii) the Transaction has been completed to the satisfaction of the Receiver.

C. Unless otherwise indicated herein, terms with initial capitals have the meanings set out in the Sale Agreement.

THE RECEIVER CERTIFIES the following:

2. The New Thane Purchasers have paid and the Receiver has received the Purchase Price for the Assets payable on the Closing Date pursuant to the Sale Agreement;
3. The conditions to Closing as set out in Article 4 of the Sale Agreement have been satisfied or waived by the Receiver and the New Thane Purchasers; and
4. The Transaction has been completed to the satisfaction of the Receiver.
5. This Certificate was delivered by the Receiver at ● on ●.

Richter Advisory Group Inc., in its capacity as
Receiver of the assets, undertakings and properties
of the Debtors, and not in its personal capacity

Per: _____
Name:
Title:

SCHEDULE "B"

Vesting of Assets

<u>Thane Receivership Company</u>	<u>Assets/Shares Being Sold</u>	<u>Purchaser</u>
Thane International, Inc.	IP Assets	652134 Limited ("New Thane IPCO (UK)")
	Other Assets	635427, Inc. ("New Thane US")
Thane Direct, Inc.	Shares – 80% equity interest in Grupo Mejor Compra SAPI de CV	9472541 Canada Inc. ("New Thane Holdco")
	Other Assets	New Thane Holdco
Thane Direct Company	Shares: <ul style="list-style-type: none"> • Danoz Direct Pty Ltd. • TVNS Scandanavia AB • Thane Direct UK Ltd. 	New Thane Holdco
	IP Assets	New Thane IPCO (UK)
	Other Assets	9472550 Canada Inc. ("New Thane Canada")
	IP Licence with New Thane IPCO(UK)	New Thane Canada
Thane Direct Marketing Inc.	Shares: <ul style="list-style-type: none"> • Medio Latino Inc. • Thane USA, Inc. 	New Thane U.S.
	Other Assets	New Thane Canada
West Coast Direct Marketing, Inc.	Other Assets	New Thane U.S.
TDG, Inc.	Other Assets	New Thane U.S.
Thane Direct Canada Inc.	IP Assets	New Thane IPCO (UK)
	IP Licence with New Thane IPCO (UK)	New Thane Canada
	Other Assets	New Thane Canada

Note that in the foregoing chart "Other Assets" refers to any asset owned by a Thane Receivership Company except intellectual property assets, intellectual property licence rights pursuant to licences given to certain of the Thane Receivership Companies by New Thane IPCO (UK) as a closing step and Excluded Assets described in the Offer. Other Assets can include Thane Group contractual rights, equipment, inventory and accounts receivable, as applicable.

SCHEDULE "C"

Encumbrances

Personal Property Security Act						
	Bank of Montreal, as Agent	666420336	20101207 1700 1590 3006 (6 years)	December 7, 2010	Thane Direct Company	I, E, A, O, MV
	Bank of Montreal, as Agent	666420327	20101207 1659 1590 3005 (6 years)	December 7, 2010	Thane Direct Canada Inc.	I, E, A, O, MV
	Bank of Montreal, as Agent	710681778	20151007 1623 1862 9770 (2 years)	October 7, 2015	Thane Direct Marketing Inc.	I, E, A, O, MV
	Bank of Montreal, as Agent	666420354	20101207 1700 1590 3007 (6 years)	December 7, 2010	Thane Direct, Inc.	I, E, A, O, MV
Uniform Commercial Code						

SCHEDULE "D"

Permitted Encumbrances

BMW Canada Inc.	703790991	20150224 1039 1529 9581 (4 years)	February 24, 2015	Thane Direct Canada Inc.	E, O, MV Amount: \$75149 2015 BMW Model X6 xDrive 35I
BMW Canada Inc.	701504037	20141112 1442 1530 2922 (5 years)	November 12, 2014	Thane Direct Canada Inc.	CG, E, O, MV Amount: \$69169 2015 BMW, Model X4 xDrive 35I
Mercedes-Benz Financial Services Canada Corporation and Mercedes-Benz Financial	692119602	20131125 1942 1531 4299 (3 years)	November 25, 2013	Thane Direct Canada Inc.	E, O, MV 2014 Mercedes-Benz, Model GLK3504M
Mercedes-Benz Financial Services Canada Corporation and Mercedes-Benz Financial	691288407	20131023 1937 1531 9932 (3 years)	October 23, 2013	Thane Direct Canada Inc.	CG, E, O, MV Amount: \$73612 2014 Mercedes-Benz, Model E350C4M
Mercedes-Benz Financial Services Canada Corporation and Mercedes-Benz Financial	687481461	20130604 1937 1531 9933 (3 years)	June 4, 2013	Thane Direct Canada Inc.	E, O, MV 2014 Mercedes-Benz Model E550W4M

Mercedes-Benz Financial					
----------------------------	--	--	--	--	--

● Court File No.: CV-15-

BANK OF MONTREAL - and - **THANE INTERNATIONAL, INC., THANE DIRECT, INC., THANE DIRECT COMPANY, THANE DIRECT MARKETING INC., WEST COAST DIRECT MARKETING, INC., THANE DIRECT CANADA INC. AND TDG, INC.**

Applicant

Respondents

ONTARIO
SUPERIOR COURT OF JUSTICE
(COMMERCIAL LIST)

(PROCEEDING COMMENCED AT TORONTO)

APPROVAL, VESTING AND DISTRIBUTION
ORDER

Gowling Lafleur Henderson LLP
Barristers and Solicitors
1 First Canadian Place
100 King Street West, Suite 1600
Toronto, Ontario M5X 1G5

Clifton P. Prophet (LSUC No.: 34845K)
Telephone: (416) 862-3509
Facsimile: (416) 862-7661

Solicitors for Bank of Montreal

EXHIBIT E-3
FORM OF U.S. RECOGNITION ORDER
[SECTION 4.3]

**IN THE UNITED STATES BANKRUPTCY COURT
FOR THE DISTRICT OF DELAWARE**

<i>In re</i>)	Chapter 15
)	
THANE INTERNATIONAL, INC., <i>et al.</i> , ¹)	Case No. 15-____ (____)
)	
Debtors in a Foreign Proceeding.)	(Jointly Administered)
)	

ORDER GRANTING RECOGNITION AND RELATED RELIEF

THIS MATTER was brought before the Court by Richter Advisory Group Inc., the duly appointed and acting receiver (the “*Receiver*”) and foreign representative of Thane International, Inc., Thane Direct, Inc., Thane Direct Company, West Coast Direct Marketing, Inc., TDG, Inc., Thane Direct Canada Inc. and Thane Direct Marketing, Inc. (collectively, the “*Thane Debtors*”) in Canadian receivership proceedings pending in Toronto, Ontario (together, the “*Canadian Proceeding*”) under Canada’s *Bankruptcy and Insolvency Act* and Ontario’s *Courts of Justice Act*, subject to the supervision of the Ontario Superior Court of Justice (Commercial List).

The Receiver filed Verified Petitions for Recognition of Canadian Receivership Proceedings and Related Relief on October __, 2015 (the “*Chapter 15 Petitions*”), commencing the above-captioned cases under chapter 15 of title 11 of the United States Code (as amended, the “*Bankruptcy Code*”) and seeking the entry of an order recognizing the Canadian Proceeding as a “foreign main proceeding” under section 1517 of the Bankruptcy Code and granting such other relief as is appropriate in the circumstances.

The Court has considered and reviewed the Chapter 15 Petitions and the other pleadings and exhibits submitted by the Receiver in support thereof.

¹ The last four digits of the Employer Identification Number for each debtor follow in parentheses: Thane International, Inc. (____), Thane Direct, Inc. (____), Thane Direct Company (____), West Coast Direct Marketing, Inc. (____), TDG, Inc. (____), Thane Direct Canada Inc. (____) and Thane Direct Marketing, Inc. (____).

Due and timely notice of the filing of Chapter 15 Petitions was given pursuant to Rule 2002(q) of the Federal Rules of Bankruptcy Procedure.

No objections were filed to the Chapter 15 Petitions.

After due deliberation and sufficient cause appearing therefor, the Court finds and concludes as follows:

(A) this Court has jurisdiction over this matter pursuant to 28 U.S.C. §§ 157 and 1334, 11 U.S.C. § 1501;

(B) this is a core proceeding pursuant to 28 U.S.C. § 157(b)(2)(P);

(C) venue is proper in this District pursuant to 28 U.S.C. § 1410;

(D) the Receiver is a “person” within the meaning of 11 U.S.C. § 101(41) and is the duly appointed “foreign representative” of the Thane Debtors within the meaning of 11 U.S.C. § 101(24);

(E) the cases were properly commenced pursuant to 11 U.S.C. §§ 1504 and 1509, and the Chapter 15 Petitions meet the requirements of 11 U.S.C. §§ 1504 and 1515;

(F) the Canadian Proceeding is a foreign proceeding within the meaning of 11 U.S.C. § 101(23);

(G) the Canadian Proceeding is entitled to recognition by this Court pursuant to 11 U.S.C. § 1517;

(H) the Canadian Proceeding is pending in Toronto, Ontario, Canada, where each of the Thane Debtors has its center of main interests within the meaning of 11 U.S.C. § 1502(4), and as such constitutes a “foreign main proceeding” pursuant to 11 U.S.C. § 1502(4) and is entitled to recognition as a foreign main proceeding pursuant to 11 U.S.C. § 1517(b)(1);

(I) the Receiver is entitled to additional relief pursuant to 11 U.S.C. § 1521(a)(7) including the application of 11 U.S.C. § 365 in these chapter 15 cases, and all relief afforded foreign main proceedings automatically upon recognition pursuant to 11 U.S.C. § 1520, including, without limitation, 11 U.S.C. §§ 362 and 363; and

(J) the relief granted herein is necessary and appropriate, in the interest of the public and international comity, and consistent with the public policy of the United States.

NOW, THEREFORE, IT IS HEREBY ORDERED AS FOLLOWS:

1. The Canadian Proceeding is hereby recognized as a foreign main proceeding pursuant to section 1517(b)(1) of the Bankruptcy Code, and all automatic relief under section 1520 of the Bankruptcy Code shall apply in these cases, including without limitation, sections 362(a) and 363 of the Bankruptcy Code.

2. The following additional relief is granted pursuant to section 1521 of the Bankruptcy Code:

(a) The commencement or continuation of any action or proceeding concerning the assets, rights, obligations or liabilities of the Thane Debtor including any action or proceeding against Richter Advisory Group Inc. in its capacity as Receiver, to the extent not stayed under section 1520(a) of the Bankruptcy Code, is hereby stayed;

(b) Execution against the assets of the Thane Debtors, located in the United States to the extent not stayed under section 1520(a) of the Bankruptcy Code is hereby stayed;

(c) Application of section 365 of the Bankruptcy Code in these chapter 15 cases is hereby granted;

(d) The administration or realization of all or part of the assets of the Thane Debtors the United States is hereby entrusted to the Receiver, and the terms of the order appointing the Receiver in the Canadian Proceeding shall apply to the Thane Debtors, its creditors, the Receiver, and any other parties-in-interest; and

(e) The right of any person or entity, other than the Receiver, to transfer or otherwise dispose of any assets of the Thane Debtors located in the United States, to the extent not suspended under section 1520(a) of the Bankruptcy Code, is hereby suspended unless authorized in writing by Order of this Court.

3. The provisional relief provided by this Court's order entered on October __, 2015 (D.I. __) is hereby extended pursuant to section 1521(a)(6) of the Bankruptcy Code.

4. This Court shall retain jurisdiction with respect to the enforcement, amendment or modification of this Order, any request for additional relief or any adversary proceeding brought in and through these cases, and any request by an entity for relief from the provisions of this Order, for cause shown, that is properly commenced and within the jurisdiction of this Court.

5. Notwithstanding Bankruptcy Rule 7062, made applicable to these cases by Bankruptcy Rule 1018, the terms and conditions of this Order shall be immediately effective and enforceable upon its entry, and upon its entry, this Order shall become final and appealable.

Dated: Wilmington, Delaware
_____, 2015

United States Bankruptcy Judge

EXHIBIT E-4
FORM OF U.S. FINAL SALE APPROVAL ORDER
[SECTION 4.3]

**IN THE UNITED STATES BANKRUPTCY COURT
FOR THE DISTRICT OF DELAWARE**

<i>In re</i>)	
)	Chapter 15
)	
THANE INTERNATIONAL, INC., <i>et al.</i> , ²)	Case No. 15-____ (____)
)	
Debtors in a Foreign Proceeding.)	(Jointly Administered)
)	

**ORDER PURSUANT TO SECTIONS 105(A), 363, 1501, AND 1521 OF THE
BANKRUPTCY CODE, AND BANKRUPTCY RULES 2002, 6004, AND 9014, FOR ENTRY OF AN
ORDER (I) RECOGNIZING AND ENFORCING THE APPROVAL ORDER AND VESTING ORDER,
(II) AUTHORIZING THE SALE OF SUBSTANTIALLY ALL OF THE DEBTORS' ASSETS FREE AND
CLEAR OF ANY AND ALL LIENS, CLAIMS, ENCUMBRANCES, AND OTHER INTERESTS,
(III) AUTHORIZING ASSIGNMENT OF CERTAIN EXECUTORY CONTRACTS AND
UNEXPIRED LEASES, AND (IV) GRANTING RELATED RELIEF**

Upon consideration of the Motion (the "*Motion*")³ of Richter Advisory Group, Inc., in its capacity as the court-appointed receiver and authorized foreign representative (the "*Receiver*") for the above-captioned debtors (collectively, the "*Thane Debtors*") in the proceeding (the "*Canadian Proceeding*") commenced under Canada's *Bankruptcy and Insolvency Act* (Canada) and pending before the Ontario Superior Court of Justice, Commercial List (the "*Canadian Court*"), for the entry of an order, pursuant to sections 105(a), 363(b), (f), (m), and (n), 1501, and 1521 of title 11 of the United States Code (the "*Bankruptcy Code*"), Rules 2002, 6004, and 9014 of the Federal Rules of Bankruptcy Procedure (the "*Bankruptcy Rules*") and Rule 6004-1 of the Local Rules of Bankruptcy Practice and Procedure for the United States Bankruptcy Court for the District of Delaware (the "*Local Rules*"): (a) recognizing and enforcing paragraphs __ of the Receivership Order (as defined below) (such paragraphs in the Receivership Order, the "*Approval Order*") and the Vesting Order, pursuant to which the Canadian Court has authorized the sale and transfer (the "*Sale*") by the Receiver of the Debtors' right, title, and interest in and

² The last four digits of the Employer Identification Number for each Thane Debtor follow in parentheses: Thane International, Inc. (____), Thane Direct, Inc. (____), Thane Direct Company (____), West Coast Direct Marketing, Inc. (____), TDG, Inc. (____), Thane Direct Canada Inc. and Thane Direct Marketing, Inc. (____).

³ Capitalized terms not otherwise defined herein shall have the meanings given to them in the Motion.

to substantially all of the Thane Debtors' assets (collectively, the "*Purchased Assets*") a newly incorporated Canadian entity ("*New Thane Holdco*") and certain subsidiaries (together with New Thane Holdco, the "*New Thane Purchasers*"), pursuant to that certain Offer to Purchase (the "*Purchase Agreement*"), by and between the Receiver and the New Thane Purchasers, dated October __, 2015, free and clear of all claims, liabilities and encumbrances, except as set forth in the Purchase Agreement; (b) authorizing, pursuant to section 363 of the Bankruptcy Code, the Sale of the Thane Debtors' right, title, and interest in and to the Purchased Assets to the New Thane Purchasers, free and clear of all Interests (as defined herein), except as otherwise provided in the Purchase Agreement; (c) authorizing and approving, to the extent provided for in the Vesting Order, the assignment of the Contracts to be assigned to the New Thane Purchasers pursuant to the Purchase Agreement (the "*Assumed Contracts*"); and (d) granting certain related relief; and this Court having entered the Order Granting Recognition and Related Relief (D.I. __, the "*Recognition Order*"); and upon the Report of Richter Advisory Group, Inc. dated October __, 2015 (the "*Receiver Report*") and the Affidavit of Paul Findlay (the "*Findlay Affidavit*") attached to the Motion; and all parties in interest having been heard, or having had the opportunity to be heard, regarding the recognition and enforcement of the Approval Order and the Vesting Order and the approval of the Purchase Agreement and transactions contemplated thereby; and the Canadian Court having entered the Approval Order and Vesting Order; and this Court having reviewed and considered the Motion, the arguments of counsel made, and the evidence adduced, at a hearing before this Court (the "*Sale Hearing*"); and upon the record of the Sale Hearing and these chapter 15 cases, and after due deliberation thereon, and good cause appearing therefor, and in accordance with Rule 7052 of the Bankruptcy Rules, it is hereby

FOUND AND DETERMINED THAT:

A. The Canadian Court has duly entered the Approval Order and the Vesting Order: (i) approving and authorizing the Thane Debtors' execution of the Purchase Agreement and consummation of the sale of the Purchased Assets and the assignment of the Assumed Contracts free and clear of all Interests; and (ii) requesting aid and recognition from this Court to give effect to the Approval Order and the Vesting Order.

B. This Court has jurisdiction and authority to hear and determine the Motion pursuant to 28 U.S.C. §§ 1334 and 157(b). Venue of these chapter 15 cases and the Motion in this Court and this District is proper under 28 U.S.C. § 1410.

C. Based on the affidavits of service filed with, and representations made to, this Court: (i) notice of the Motion, the Sale Hearing, and the Sale were proper, timely, adequate, and sufficient under the circumstances of these Chapter 15 Cases and these proceedings and complied with the various applicable requirements of the Bankruptcy Code and the Bankruptcy Rules; and (ii) no other or further notice of the Motion, the Sale Hearing, the Sale, or the entry of this Order is necessary or shall be required.

D. The Receiver provided a reasonable opportunity to object and be heard with respect to the Sale, the Motion, and the relief requested therein to the necessary parties in interest, including the following: (i) all known creditors of the Thane Debtors or holders of Interests; (ii) all parties to litigation pending in the United States in which the Thane Debtors are a party as of the Petition Date; (iii) the Office of the United States Trustee for the District of Delaware; (iv) the United States Attorney's Office for the District of Delaware; (v) the Internal Revenue Service; (vi) the United States Department of Justice; (vii) counsel for the Purchaser; (viii) counsel to the Senior Lenders; (ix) all persons or entities known to have liens on the Purchased Assets; and (x) all counterparties to the Assumed Contracts.

E. This Order constitutes a final and appealable order within the meaning of 28 U.S.C. § 158(a).

F. The relief granted herein is necessary and appropriate, is in the interest of the public, promotes international comity, is consistent with the public policy of the United States, is warranted pursuant to sections 105(a), 363(b), (f), (m), and (n), 1501, and 1521 of the Bankruptcy Code, and will not cause any hardship to any parties in interest that is not outweighed by the benefits of the relief granted.

G. The Vesting Order provides for the assignment of the Assumed Contracts, as permitted under the *Bankruptcy and Insolvency Act*, and such provisions of the *Bankruptcy and Insolvency Act* are consistent with section 365(f) of the Bankruptcy Code. As such, enforcement in the United States of the assignment of the Assumed Contracts to the Purchaser does not present any public policy conflict or any issue concerning protection of the interests of the parties to the Assumed Contracts that would prevent this Court from entering this Order.

H. Based on information contained in the Receiver Report and the Findlay Affidavit, the Thane Debtors, through SSG, conducted a prepetition marketing process for the sale of the Thane Debtors' assets. The Canadian Court found that the prepetition marketing process was sufficient and appropriate under the circumstances to support approval of the Sale pursuant to the terms of the Purchase Agreement and entered the Approval Order.

I. The Receiver has recommended the Sale in accordance with the Purchase Agreement, including the assignment of the Assumed Contracts. The New Thane Purchasers are able and have agreed to assume and perform the obligations of the Thane Debtors under the Assumed Contracts in accordance with their terms, including the payment of arrears in accordance with the Purchase Agreement, and it is appropriate that the Purchased Assets,

including the Assumed Contracts, be transferred, assigned, and vested in the New Thane Purchasers.

J. The consideration provided by the New Thane Purchasers for the Purchased Assets is the highest or otherwise best offer.

K. The Purchase Price constitutes fair consideration and reasonably equivalent value for the Purchased Assets under the Bankruptcy Code, the Uniform Fraudulent Transfer Act, the Uniform Fraudulent Conveyance Act, and the laws of the United States, any state, territory, possession thereof, or the District of Columbia.

L. No bulk sales law or any similar law of any state or other jurisdiction shall apply in any way to the Sale.

M. Time is of the essence in consummating the Sale. To maximize the value of the Purchased Assets, it is essential that the Sale occur promptly. Accordingly, there is cause to waive the stay that would otherwise be applicable under Bankruptcy Rule 6004.

N. Based upon information contained in the Receiver Report and the Findlay Affidavit, the negotiations over the terms of the Purchase Agreement were conducted fairly, in good faith, and without collusion, and thus the New Thane Purchasers have acted in good faith within the meaning of section 363(m) of the Bankruptcy Code, and neither the Receiver nor the New Thane Purchasers engaged in any conduct that would cause or permit the Purchase Agreement or the consummation of the Sale to be avoided, or costs or damages to be imposed, under section 363(n) of the Bankruptcy Code.

O. The Purchase Agreement was not entered into for the purpose of hindering, delaying, or defrauding present or future creditors of the Thane Debtors under the Bankruptcy Code or under the laws of the United States, any state, territory, possession thereof, or the District of Columbia.

P. The Receiver may sell the Purchased Assets free and clear of all Interests, to the extent provided in the Purchase Agreement, the Approval Order, the Vesting Order, and this Order, because, with respect to each creditor asserting an Interest, one or more of the standards set forth in section 363(f)(1)-(5) of the Bankruptcy Code has been satisfied. Those holders of Interests who did not object or who withdrew their objections to the Sale or the Motion are deemed to have consented to the Motion and Sale pursuant to Bankruptcy Code section 363(f)(2).

Q. The New Thane Purchasers would not have entered into the Purchase Agreement and would not consummate the transactions contemplated thereby, thus adversely affecting the Thane Debtors, their creditors, and other parties in interest if either: (i) the sale of the Purchased Assets to the New Thane Purchasers was not free and clear of all Interests, except as otherwise provided in the Purchase Agreement; or (ii) the New Thane Purchasers would, or in the future could, be liable for any of such Interests or any claims against the Debtors based upon successor or vicarious liability or otherwise, except as provided in Purchase Agreement.

R. A sale of the Purchased Assets other than one free and clear of all Interests, except as otherwise provided in the Purchase Agreement, would yield substantially less value than the Sale; thus, the Sale free and clear of all Interests, in addition to all of the relief provided herein, is in the best interests of the Thane Debtors, their creditors, and other parties in interest.

S. All findings of fact and conclusions of law announced by this Court at the Sale Hearing are incorporated herein.

IT IS HEREBY ORDERED, ADJUDGED, AND DECREED THAT:

1. The Motion is granted.

2. The Approval Order and the Vesting Order, copies of which are attached hereto as Exhibit 1 and Exhibit 2, respectively, are recognized in full and given full force and effect in the United States.

3. The Sale pursuant to the terms of the Purchase Agreement and the transfer and assignment of the Purchased Assets located within the United States is approved and authorized pursuant to sections 363 and 1521 of the Bankruptcy Code.

4. All objections to the entry of the this Order that have not been withdrawn, waived, or settled, or otherwise resolved pursuant to the terms hereof, are denied and overruled on the merits, with prejudice.

5. Pursuant to sections 105, 363, and 1521 of the Bankruptcy Code, and to the extent permitted by the Approval Order and the Vesting Order, each of the Thane Debtors, the New Thane Purchasers, and the Receiver are authorized to take any and all actions necessary or appropriate to: (a) consummate the Sale of the Purchased Assets to the New Thane Purchasers in accordance with the Purchase Agreement, the Approval Order, the Vesting Order, and this Order; and (b) perform, consummate, implement, and close fully the Purchase Agreement, together with all additional instruments and documents that may be reasonably necessary or desirable to implement the Purchase Agreement and the Sale.

TRANSFER OF THE PURCHASED ASSETS

6. Pursuant to sections 105(a), 363(f), and 1521 of the Bankruptcy Code, and as provided for in the Approval Order, and the Vesting Order, upon delivery of the Receiver's Certificate to the New Thane Purchasers in accordance with the Vesting Order, the Purchased Assets shall absolutely vest, without further instrument of transfer or assignment, in the New Thane Purchasers and shall be a legal, valid, and effective transfer of the Purchased Assets free and clear any and all security interests (whether contractual, statutory, or otherwise), mortgages,

pledges, options, warrants, trusts or deemed trusts (whether contractual, statutory, or otherwise), encumbrances, obligations, liabilities, demands, guarantees, restrictions, contractual commitments, rights, including without limitation, rights of first refusal and rights of set-off, liens, executions, levies, penalties, charges, or other financial or monetary claims, adverse claims, or rights of use, puts or forced sales provisions exercisable as a consequence of or arising from the closing of the Sale, whether arising prior to or subsequent to the commencement of the Canadian Proceeding and these Chapter 15 Cases, whether or not they have attached or been perfected, registered or filed and whether secured, unsecured, legal, equitable, possessory or otherwise, actual or threatened civil, criminal, administrative, regulatory, arbitral or investigative inquiry, action, complaint, suit, investigation, dispute, petition or proceeding by or before any governmental authority or person at law or in equity whether imposed by agreement, understanding, law, equity or otherwise, and any claim or demand resulting therefrom including, without limiting the generality of the foregoing: (a) any encumbrances or charges created by the Receivership Order and/or any subsequent charges created by the Canadian Court; (b) all charges, security interests, or claims evidenced by any personal property registry system in the United States; and (c) excluded liabilities as set forth in ___ of the Purchase Agreement (all the foregoing in this paragraph ___, collectively, the "*Interests*"); *provided, however*, that nothing contained herein shall derogate from the obligations of the New Thane Purchasers to assume the Assumed Obligations (as defined in the Purchase Agreement), and to perform its obligations under the Assumed Contracts.

7. Except as expressly provided in the Purchase Agreement, the Approval Order, the Vesting Order, and/or this Order, pursuant to sections 105(a), 363(f), and 1521 of the Bankruptcy Code, upon the time of closing of the Sale (the "*Time of Closing*"): (a) the Purchased Assets shall be sold, transferred, or otherwise conveyed to the New Thane Purchasers free and clear of

all Interests; (b) no holder of an Interest against the Thane Debtors shall interfere with the New Thane Purchasers' title to or use and enjoyment of the Purchased Assets based on or related to such Interests; and (c) the Purchase Agreement, the Sale, and any instruments contemplated thereby shall be enforceable against and binding upon, and not subject to rejection or avoidance by, the Thane Debtors or any successor thereof. All persons or entities holding Interests in, to or against the Purchased Assets are forever barred from asserting such Interests against the New Thane Purchasers, their affiliates, successors and assigns, and current affiliates, officers, directors, employees, managers, partners, members, financial advisors, attorneys, agents, and representatives (collectively, the "*Purchaser Releasees*") or such Purchased Assets after the Time of Closing.

8. None of the Purchaser Releasees shall have or incur any liability to, or be subject to any action by any Thane Debtor, or any of the Thane Debtors' predecessors, successors, or assigns, arising out of the negotiation, investigation, preparation, execution, or delivery of the Purchase Agreement, or the entry into and consummation of the Sale, except as expressly provided in the Purchase Agreement, the Approval Order, the Vesting Order, and/or this Order.

9. Except as otherwise provided in the Purchase Agreement, any and all Purchased Assets in the possession or control of any person or entity, including, without limitation, any vendor, supplier, or employee of the Thane Debtors shall be transferred to the New Thane Purchasers free and clear of all Interests, and, upon reasonable request of the New Thane Purchasers, all such persons or entities are directed to surrender possession of the Purchased Assets to the New Thane Purchasers at the Time of Closing.

10. To the extent permissible under the Approval Order and the Vesting Order, the New Thane Purchasers, or their affiliates, members, and shareholders, shall not be deemed, as a result of any action taken in connection with the Sale or the New Thane Purchasers' post-closing use or

operation of the Purchased Assets, to: (a) be a successor to the Thane Debtors; (b) have, *de facto* or otherwise, merged or consolidated with or into the Thane Debtors; or (c) be a continuation or substantial continuation of the Thane Debtors or any enterprise of the Thane Debtors. Except for the Assumed Obligations, the transfer of the Purchased Assets to the New Thane Purchasers under the Purchase Agreement, the Approval Order, the Vesting Order, and this Order shall not result in the Purchaser Releasees having any liability or responsibility whatsoever: (y) for any Interest against the Thane Debtors or against an insider of the Thane Debtors; or (z) to the Thane Debtors, except as is expressly set forth in the Purchase Agreement, the Approval Order, the Vesting Order, the U.S. Sale Order, and/or any other order of the Canadian Court. Without limiting the generality of the foregoing, except as otherwise provided in the Purchase Agreement, the Approval Order, this Order, or any other order of the Canadian Court, the conveyance of the Thane Debtors' rights, title, and interest in the Purchased Assets to Purchaser under the Purchase Agreement shall not result in any Purchaser Releasee having any liability or responsibility whatsoever for any: (a) Interest, whether at law or in equity, whether by payment, setoff, or otherwise, directly or indirectly; (b) obligation under any of the Thane Debtors' labor or employment agreements; (c) of the Thane Debtors' mortgages, deeds of trust, and security interests; (d) intercompany loans and receivables between the Thane Debtors and any non-debtor subsidiary or affiliate; (e) of the Thane Debtors' pension, welfare, compensation or other employee benefit plans, agreements, practices and programs; (f) any of the Thane Debtors' other employee, worker's compensation, occupational disease, unemployment, or temporary disability related claim, including without limitation, claims that might arise under or pursuant to (i) the Employee Retirement Income Security Act of 1974, as amended, (ii) the Fair Labor Standards Act, (iii) Title VII of the Civil Rights Act of 1964, (iv) the Federal Rehabilitation Act of 1973, (v) the National Labor Relations Act, (vi) the Worker Adjustment and Retraining Act of 1988,

(vii) the Age Discrimination and Employee Act of 1976 and Age Discrimination in Employment Act, as amended, (viii) the Americans with Disabilities Act of 1990, (ix) the Consolidated Omnibus Budget Reconciliation Act of 1985, (x) state discrimination laws, (xi) state unemployment compensation laws or any other similar state laws, (xii) any other state or federal benefits or claims relating to any employment with the Thane Debtors or any of their predecessors; or (g) successor or vicarious liabilities of any kind or character, including, but not limited to, federal, state or other tax liabilities, U.S. or foreign pension liabilities, or liabilities based on any theory of antitrust, environmental, labor law, alter ego, veil piercing, continuity of enterprise, mere continuation, product line, *de facto* merger or substantial continuity, whether known or unknown, whether legal or equitable, matured or unmatured, contingent or noncontingent, liquidated or unliquidated, asserted or unasserted, whether arising prior to or subsequent to the commencement of these Chapter 15 Cases, whether imposed by agreement, understanding, law, equity or otherwise with respect to any of the Thane Debtors or any obligations of the Thane Debtors, including, but not limited to, in the case of liabilities on account of any taxes arising, accruing or payable under, out of, in connection with, or in any way relating to the operation of the Thane Debtors' business prior to the Time of Closing or any taxes in connection with, or in any way relating to the cancellation of debt of the Thane Debtors or their affiliates.

11. The entry of this Order: (a) is and shall be effective as a determination that, upon the Time of Closing, except as expressly provided in the Purchase Agreement, the Approval Order, the Vesting Order, and/or the U.S. Sale Order, all Interests existing as to the Purchased Assets prior to the Time of Closing, have been released, extinguished, expunged, and discharged as against the Purchased Assets; and (b) shall be binding upon and shall govern the acts of all entities, including, without limitation, all filing agents, filing officers, title agents, title

companies, recorders of mortgages, recorders of deeds, recorders of fees, registrars of deeds, administrative agencies, governmental departments, secretaries of state, federal, state, and local officials, and all other persons and entities, who may be required by operation of law, the duties of their office, or contract, to accept, file, register or otherwise record or release any documents or instruments that reflect that the New Thane Purchasers are the assignee of the Purchased Assets free and clear of all Interests, except as expressly provided in the Purchase Agreement, the Approval Order, the Vesting Order, and/or this Order.

12. Each and every federal, state, and local governmental agency or department is authorized and directed to accept any and all documents and instruments necessary and appropriate to consummate the transaction contemplated by the Purchase Agreement.

13. Except with respect to enforcing the terms of the Purchase Order, the Approval Order, the Vesting Order, or this Order, absent a stay pending appeal, no person shall take any action to prevent or enjoin or otherwise interfere with consummation of the transaction contemplated in or by the Purchase Agreement.

14. Effective as of the Time of Closing, the Approval Order, the Vesting Order and this Order shall constitute for any and all purposes a full and complete general assignment, conveyance, and transfer of the Thane Debtors' interests in the Purchased Assets.

TREATMENT OF EXECUTORY CONTRACTS AND UNEXPIRED LEASES

15. As provided in the Purchase Agreement, the Approval Order and the Vesting Order, upon delivery of the Receiver's Certificate, the Assumed Contracts shall be transferred to, and remain in full force and effect for the benefit of, the New Thane Purchasers in accordance with their respective terms. The transfer and assignment of the Assumed Contracts shall be valid notwithstanding any restriction, condition, or prohibition contained in any such Assumed Contract relating to the assignment thereof (including those of the type described in

sections 365(b)(2) and (f) of the Bankruptcy Code) that prohibits, restricts, or conditions such assignment or transfer or requires the consent of any party to such assignment or transfer.

16. As provided in paragraph ___ of the Vesting Order, the assignment of the rights and obligations of the Thane Debtors under the Assumed Contracts to the New Thane Purchasers, pursuant to section ___ of the Purchase Agreement, is valid and binding upon all of the counterparties to the Assumed Contracts, without further documentation, as if the New Thane Purchasers were a party to the Assumed Contracts, notwithstanding any restriction or prohibition contained in any such Assigned Contract relating to the assignment thereof, including any provision requiring the consent of any party to an Assigned Contract.

17. Each counterparty to the Assumed Contracts is prohibited from exercising any right or remedy under the Assumed Contracts by reason of any defaults thereunder arising from the commencement or pendency of the Canadian Proceeding or these Chapter 15 Cases or the solvency or financial condition of the Thane Debtors.

18. To the extent there may be any dispute arising from this Order's treatment of any Assumed Contract, including, but not limited to, disputes related to an attempted post-Sale modification or termination of any Assumed Contract subject to this Court's jurisdiction, regardless of whether such modification or termination is based upon restrictions or prohibitions contained in any Assumed Contract relating to the assignment thereof, this Court shall retain jurisdiction to enforce any and all terms and provisions of the Purchase Agreement, the Approval Order, the Vesting Order, and/or this Order with respect to any such Assigned Contract.

ADDITIONAL PROVISIONS

19. The New Thane Purchasers, as purchasers in good faith within the meaning of section 363(m) of the Bankruptcy Code, shall be entitled to all of the protections of section 363(m) of the Bankruptcy Code. The reversal or modification on appeal of the

authorization provided herein to consummate the Sale shall not affect the validity of the Sale unless, prior to the Time of Closing, such authorization is duly stayed pending appeal.

20. The terms and provisions of the Purchase Agreement and this Order shall be binding on and inure to the benefit of the Thane Debtors, the New Thane Purchasers, the Thane Debtors' creditors, and all other parties in interest, and any successors of the Thane Debtors, the New Thane Purchasers and the Thane Debtors' creditors, including any trustee(s), examiner(s), or receiver(s) appointed in these cases or under any chapter of the Bankruptcy Code or any other law, and all such terms and provisions shall likewise be binding on such trustee(s), examiner(s), or receiver(s) and shall not be subject to rejection or avoidance by the Thane Debtors, their creditors, or any trustee(s), examiner(s), or receiver(s).

21. Subject to the terms and conditions of the Approval Order, the Vesting Order and the Purchase Agreement, provisions of the Purchase Agreement and any related agreements may be waived, modified, amended, or supplemented by agreement among the Receiver and the New Thane Purchasers in a writing signed by the Receiver and the New Thane Purchasers without further action or order of this Court.

22. The failure to include any particular provision of the Approval Order, the Vesting Order, the Purchase Agreement, or any related agreements in this Order shall not diminish or impair the effectiveness of that provision, it being the intent of this Court that the Approval Order, the Vesting Order, the Purchase Agreement, and any related agreements, with such amendments thereto as may be made by the parties in accordance with the Approval Order, the Vesting Order and the Purchase Agreement be approved and authorized in their entirety.

23. Notwithstanding any provision in the Bankruptcy Rules to the contrary: (a) the terms of this Order shall be immediately effective and enforceable upon its entry; (b) the Thane Debtors, the New Thane Purchasers, and the Receiver are not subject to any stay in the

implementation, enforcement or realization of the relief granted in this Order; and (c) the Thane Debtors, the New Thane Purchasers, and the Receiver may, in their discretion and without further delay, take any action and perform any act authorized under the Approval Order, the Vesting Order and/or this Order.

24. To the extent permitted by section 525 of the Bankruptcy Code, no governmental unit may revoke or suspend any permit or license relating to the operation of the Purchased Assets sold, transferred, or conveyed to the New Thane Purchasers on account of the filing or pendency of these Chapter 15 Cases or the consummation of the Sale.

25. Nothing in this Order shall be deemed to waive, release, extinguish or estop the Thane Debtors or the Receiver from asserting, or otherwise impair or diminish, any right (including, without limitation, any right of recoupment), claim, cause of action, defense, offset or counterclaim in respect of any asset that is not a Purchased Asset.

26. The provisions of the U.S. Sale Order are nonseverable and mutually dependent.

27. Other than as explicitly set forth herein, this Court shall retain jurisdiction with respect to any and all matters, claims, rights, or disputes arising from or related to the implementation or interpretation of this Order.

Dated: Wilmington, Delaware
_____, 2015

United States Bankruptcy Judge

Court File No.:

BANK OF MONTREAL - and - **THANE INTERNATIONAL, INC., THANE DIRECT, INC., THANE DIRECT COMPANY, THANE DIRECT MARKETING INC., WEST COAST DIRECT MARKETING, INC., THANE DIRECT CANADA INC. AND TDG, INC.**

Applicant

Respondents

**ONTARIO
SUPERIOR COURT OF JUSTICE
(COMMERCIAL LIST)**

(PROCEEDING COMMENCED AT TORONTO)

**AFFIDAVIT OF PAUL FINDLAY
(Sworn October 16, 2015)**

Gowling Lafleur Henderson LLP
Barristers and Solicitors
1 First Canadian Place
100 King Street West, Suite 1600
Toronto, Ontario M5X 1G5

Clifton P. Prophet (LSUC No.: 34845K)
Telephone: (416) 862-3509
Facsimile: (416) 862-7661

Solicitors for Bank of Montreal

TAB 3

Court File No.:

**ONTARIO
SUPERIOR COURT OF JUSTICE
(COMMERCIAL LIST)**

BETWEEN:

BANK OF MONTREAL

Applicant

- and -

**THANE INTERNATIONAL, INC., THANE DIRECT, INC., THANE DIRECT
COMPANY, THANE DIRECT MARKETING INC., WEST COAST DIRECT
MARKETING, INC., THANE DIRECT CANADA INC. AND TDG, INC.**

Respondents

**APPLICATION UNDER section 243 of the *Bankruptcy and Insolvency Act*,
R.S.C. 1985, c. B-3, as amended, and under section 101 of the
Courts of Justice Act, R.S.O. 1990, c. C.43**

CONSENT

RICHTER ADVISORY GROUP INC. hereby consents to act as Receiver of Thane International, Inc., Thane Direct, Inc., Thane Direct Company, Thane Direct Marketing Inc., West Coast Direct Marketing, Inc., Thane Direct Canada Inc., and TDG, Inc. in accordance with the terms of an order substantially in the form requested by Bank of Montreal.

October 16th, 2015**RICHTER ADVISORY GROUP INC.**By: 

Name: Paul van Eyk, CA CIRP, CA IFA

Title: Senior Vice-President

Court File No.:

BANK OF MONTREAL - and - **THANE INTERNATIONAL, INC., et. al**

Applicant

Respondents

**ONTARIO
SUPERIOR COURT OF JUSTICE
(COMMERCIAL LIST)**

PROCEEDINGS COMMENCED AT TORONTO

CONSENT

Gowling Lafleur Henderson LLP
Barristers and Solicitors
1 First Canadian Place
100 King Street West, Suite 1600
Toronto, Ontario M5X 1G5

Clifton P. Prophet (LSUC No.: 34845K)
Telephone: (416) 862-3509
Facsimile: (416) 862-7661

Solicitors for Bank of Montreal

Court File No.:

BANK OF MONTREAL

- and -

THANE INTERNATIONAL, INC., THANE DIRECT, INC., THANE DIRECT COMPANY, THANE DIRECT MARKETING INC., WEST COAST DIRECT MARKETING, INC., THANE DIRECT CANADA INC. AND TDG, INC.

Applicant

Respondents

ONTARIO

**SUPERIOR COURT OF JUSTICE
(COMMERCIAL LIST)**

(PROCEEDING COMMENCED AT TORONTO)

**APPLICATION RECORD
(Returnable October 23, 2015)**

GOWLING LAFLEUR HENDERSON LLP

Barristers and Solicitors
1 First Canadian Place
100 King Street West, Suite 1600
Toronto, Ontario M5X 1G5

Clifton P. Prophet (LSUC No.: 34845K)

Telephone: (416) 862-3509

Facsimile: (416) 862-7661

Solicitors for Bank of Montreal